

ROBERTS

Stream 67

Smart Audio System with Internet Radio/DAB/DAB+/FMRDS/Bluetooth/CD/USB
with Spotify/Deezer/TIDAL/Amazon Prime Music, with Multi-room and Works with Alexa
and remote control from iPhone and Android using UNDOK



Please read this manual before use

Contents

Stream 67 Smart Audio System features	2	Connecting and reconnecting a Bluetooth device	52
Before you can use this product	3	Compact discs	54
About this instruction manual	4	CD-R/CD-RW discs	54
Controls and connections	5	MP3/WMA CD Mode	54
Remote control	7	Playing a CD	55
Navigation controls	9	Selecting a track	56
Configuration	10	Search function	57
Plugging in and language selection	10	Clock and Alarms	59
Clock and time settings	11	Automatically updating the clock	59
Connecting to your computer network	12	Manually setting the clock	60
Configuration - Using the UNDOK app	18	Setting the alarm clock	61
Network remote control options	21	Snooze timer	63
Internet Radio	22	Sleep timer	64
Internet Radio - the basics	22	Multi-room - the basics	65
Selecting a radio station by location	23	Creating and editing a multi-room group with UNDOK	66
Selecting a podcast	24	Playing audio to a group	67
Presetting stations Internet radio, DAB and FM	25	Display and Controls in a multi-room configuration	68
Display options - Radio / Bluetooth / Music Player	29	Create a new multi-room group	70
Music Player	31	UNDOK Settings	75
Use with Windows, Apple Mac, Linux, USB memory	31	Display and Audio	76
Accessing your audio files via a UPnP server	32	Equaliser function	76
Locating and playing media files using UPnP	34	Subwoofer control	77
Using USB memory devices	37	Brightness control	78
Playlists	39	Headphone socket	79
Windows 'Play to' / 'Cast to Device' function	41	Auxiliary input socket	79
Spotify Connect	43	Inactive Standby feature	80
What is Spotify?	43	USB socket for smartphone or tablet charging	80
Controlling Spotify on your audio system	44	Information	81
DAB Radio	45	Factory reset	81
Selecting a DAB radio station	45	Software update	82
Finding new DAB radio stations	46	Troubleshooting	84
FM Radio	48	Audio codecs	86
Manual tuning	48	Cautions	87
Scan sensitivity setting - FM	49	Specifications	88
Bluetooth mode	50	Mains supply	89
Connecting Bluetooth devices	50	Guarantee	91
Playing audio files in Bluetooth mode	51		



Stream 67 Smart Audio System features

The Roberts Stream 67 is a Smart Audio System which provides the following features :-

- Listen to local, regional, national and international broadcasts using FM, DAB and Internet radio.
- Listen to thousands of radio stations from around the world and listen to podcasts from a wide range of broadcasters.
- 30 radio station presets (10 Internet Radio, 10 DAB and 10 FM).
- Use the Music Player to play your music collection from devices on your network.
- Playback of audio files from USB memory devices.
- MP3, WMA, AAC, FLAC, ALAC (Apple Lossless) and WAV formats are supported.
- Play MP3 and WMA files from CD.
- Voice control of primary functions using Alexa with Amazon Echo products.
- The Stream 67 connects to your home network either using a WiFi or via a wired connection. Dual band WiFi allows compatibility with a wide range of networks.
- WiFi Protected Setup (WPS) is supported for simpler setting up with compatible wireless routers.
- Works with Windows 'Play to' / 'Cast to Device' function (as a Digital Media Renderer).
- All radio station presets, network configuration details and user settings are retained in the event of a power failure.
- Spotify Connect allows your Spotify selections to be played through the audio system, remotely controlled from your iPhone, iPad, Android device or any Desktop.
- Supports remote control and plays music from Apple iPhone, iPad and Android devices using the UNDOK app.
- Your audio system may be connected as part of a wireless Multi-room system to allow whatever source is selected to be heard through other connected products.
- Bluetooth streaming to play your music or video soundtracks from your smartphone, tablet or similar device.
- Large clock display with time and date when in standby.
- Two alarm timers with snooze feature to wake you to either a buzzer, CD or a radio alarm.
- Adjustable sleep timer, can be set to turn the audio system off after a delay.
- Menu display in a choice of languages - Danish, Dutch, English, French, German, Italian, Norwegian.
- Easy-to-read colour graphic display with an adjustable display backlight.
- Auxiliary input for playing audio from MP3 players, iPods or other audio equipment.
- An acoustically tuned wooden cabinet that includes bass ports and internal bracing for optimal sound reproduction.



Before you can use this product

We recommend before using your smart audio system for the first time, to check for software updates.

[Details on updating your smart audio system can be found on page 82.](#)

You will first need to connect your audio system to your network see [Configuration page 10 onwards.](#)

Before you can use your audio system, you must have the following:

- A broadband Internet connection (not required for DAB, FM, Bluetooth or Music Player functions).
- A router (or equivalent wireless access point) providing a WiFi signal or Ethernet connection, connected to your broadband Internet Service Provider. The broadband modem, router and wireless access point will often be a single combined unit supplied by your Internet Service Provider or bought from a computer store.
- A Smart phone or tablet which uses either the Android operating system (version 4.0.3 or later) or Apple iOS (version 9 or later).
- If your wireless network requires a security password to allow connection, then you either need to know the WEP, WPA or WPA2 key used for encryption so that you can get the audio system to communicate with the network, or your router needs to offer WiFi Protected Setup (WPS).
- If you choose to connect the audio system to your network using a wired Ethernet connection, then an Ethernet cable of the appropriate length will be needed. If it is intended to listen to FM radio extensively, then there may be a benefit in using a shielded Ethernet cable since this may reduce possible interference to the radio.

The audio system's WiFi system is compatible with 802.11b, g, n or a networks and can use 2.4 GHz or 5 GHz WiFi frequency bands.

The audio system will typically work within a 10-20 metre radius from your wireless access point. The actual range achieved will depend upon the building type, other nearby wireless networks, and possible interference sources. DAB and FM radio functions can operate wherever the audio system is able to receive a suitable broadcast signal.

IMPORTANT: Before you continue, make sure that your router (or access point) is powered up and working with your broadband Internet service (use your computer, smart-phone or tablet to verify this). To get this part of the system working you must refer to the instructions supplied with those items.



About this instruction manual

This instruction manual is split into sections for each of the operating modes of your Roberts Stream 67. Each section is clearly identified by the shaded heading in the top right hand corner of each pair of pages.

Before using the Internet Radio and Music Player functions, you will need to connect your audio system to your computer network using the WiFi or ethernet connection. This is covered in the section titled **Configuration**. This section also explains how to set the menu language option.

The **Internet Radio** section describes how to find radio stations to listen to. These can be radio stations that you already know and listen to conventionally, or new stations you may search for.

The section for the **Music Player** describes how you may play music files that you may have stored on a computer connected to your network. The use of Shared Media (using UPnP) and USB playback is explained.

The **Spotify Connect** section explains the use of the audio system in conjunction with the Spotify internet based music streaming service.

The two sections for **DAB** and **FM Radio** describe how to use the radio to listen to conventional radio broadcasts.

The **Bluetooth** section describes how to use your Stream 67 to play audio files or video soundtracks directly from your smartphone, tablet or similar devices.

The **CD / MP3 / WMA** section describes how to play digital audio CDs or MP3 / WMA files which have previously been recorded to CD-R or CD-RW.

The section titled **Clock** and **Alarms** describes the different ways by which the clock may be set, as well as explaining the use of the alarms, snooze and sleep timer features.

The **Multi-room** and the **UNDOK** section explains how your audio system may be connected as part of a wireless music system.

The **Display** and **Audio** section shows how to adjust the display, use the equaliser and connect your audio system to other audio equipment.

The **Information** section includes troubleshooting, specifications and warranty information.

Introduction

[Configuration](#) (page 10)

[Internet Radio](#) (page 22)

[Music Player](#) (page 31)

[Spotify Connect](#) (page 43)

[DAB & FM Radio](#) (page 45)

[Bluetooth](#) (page 50)

[CD/MP3/WMA](#) (page 54)

[Clock and Alarms](#) (page 59)

[Multi-room & UNDOK](#) (page 65)

[Display & Audio](#) (page 76)

[Information](#) (page 81)



Controls and connections

Top view

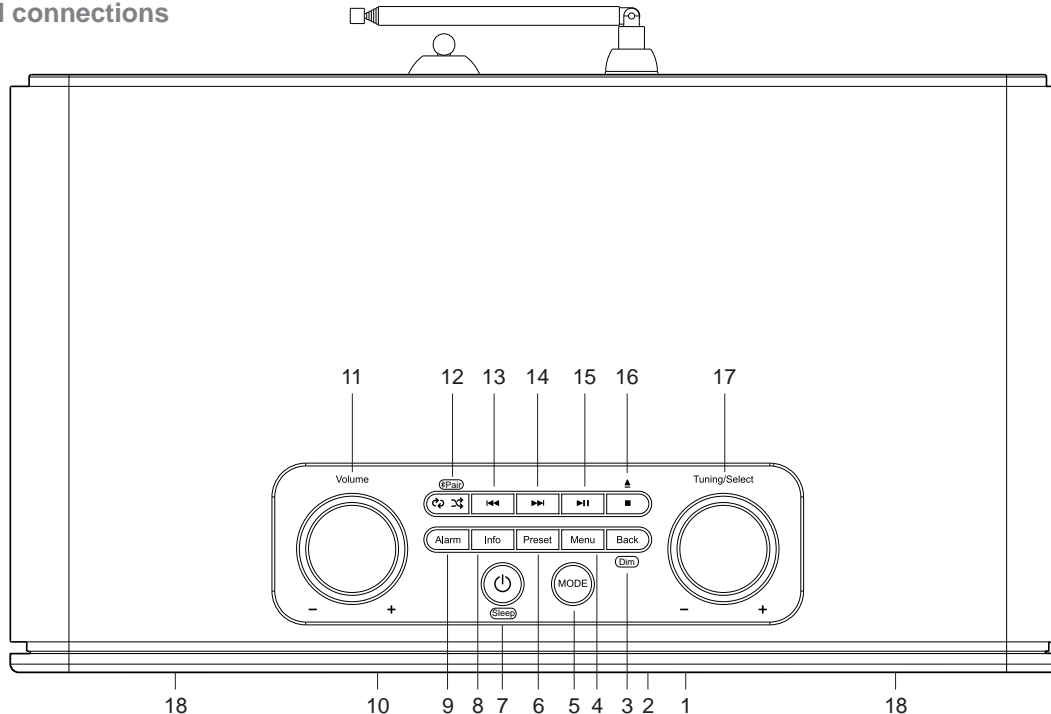

- | | | |
|--------------------------------|--|--------------------------------------|
| 1. Infra red sensor | 8. Info button | 14. Next button |
| 2. LCD display | 9. Alarm button | 15. Play / Pause button |
| 3. Back / Dimmer button | 10. CD slot | 16. Stop / Eject button |
| 4. Menu button | 11. Volume control | 17. Tuning / Select / Snooze control |
| 5. Mode button | 12. Repeat / Shuffle / Bluetooth Pair button | 18. Mid treble speakers x 2 |
| 6. Preset button | 13. Previous button | |
| 7. On / Standby / Sleep button | | |



Rear view

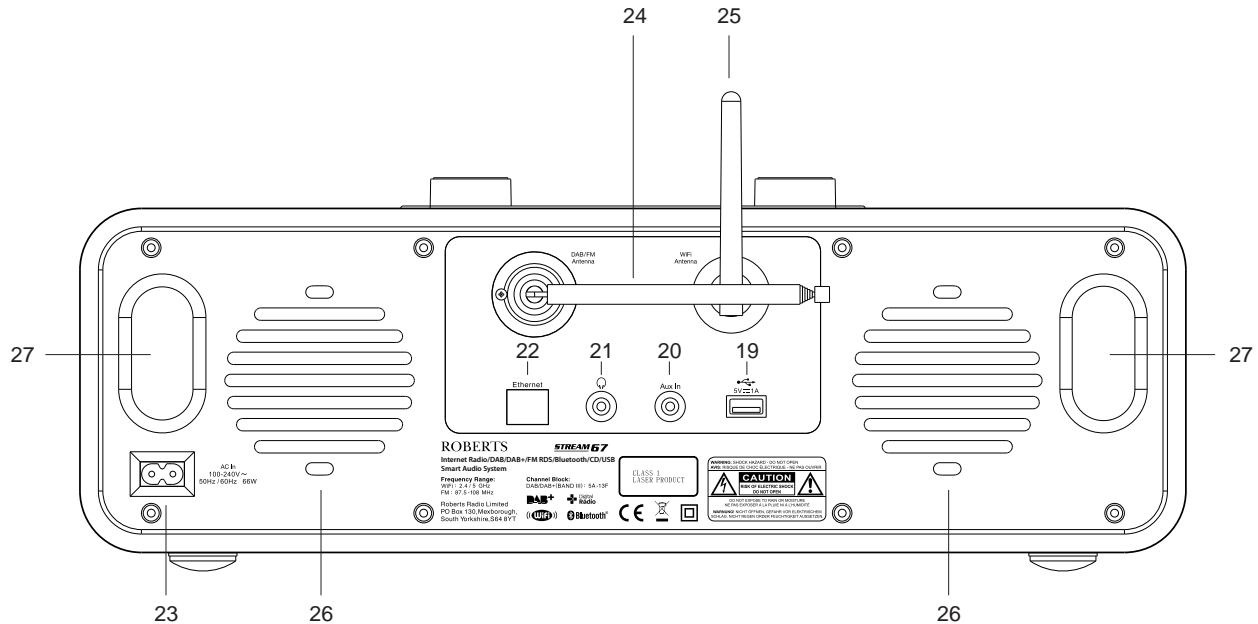

- 19. USB playback / Charge socket
- 20. Auxiliary input socket
- 21. Headphone socket
- 22. Ethernet RJ-45 socket
- 23. Mains input socket
- 24. DAB / FM telescopic aerial
- 25. WiFi antenna
- 26. Bass speakers x 2
- 27. Bass ports x 2



Remote control

- | | |
|------------------------------------|---------------------------------|
| 1. Mode button | 13. EQ button |
| 2. Infra-red LED | 14. Auto Tune button |
| 3. On / Standby button | 15. Dimmer button |
| 4. Mute button | 16. Alarm button |
| 5. Keypad buttons 1 -10 | 17. Sleep button |
| 6. Repeat / Shuffle button | 18. Bluetooth Pair button |
| 7. Menu button | 19. Info button |
| 8. Menu Up / Folder Up button | 20. Volume Down button |
| 9. Select / Stop button | 21. Menu Right / Next button |
| 10. Menu Left / Previous button | 22. Volume Up button |
| 11. Menu Down / Folder Down button | 23. Play / Pause button |
| 12. Back button | 24. Subwoofer Up / Down buttons |

Remote control functions

Most of the functions of the Stream 67 audio system can be controlled using either the product or the remote control. However, there are a few functions which are more easily accessible using the remote control. These are:

- | | |
|----------------------------|--------------------|
| Radio station presets | DAB / FM auto-tune |
| CD track access by numbers | Equaliser settings |
| Audio mute | Subwoofer settings |

The CD Eject button is on the audio system.

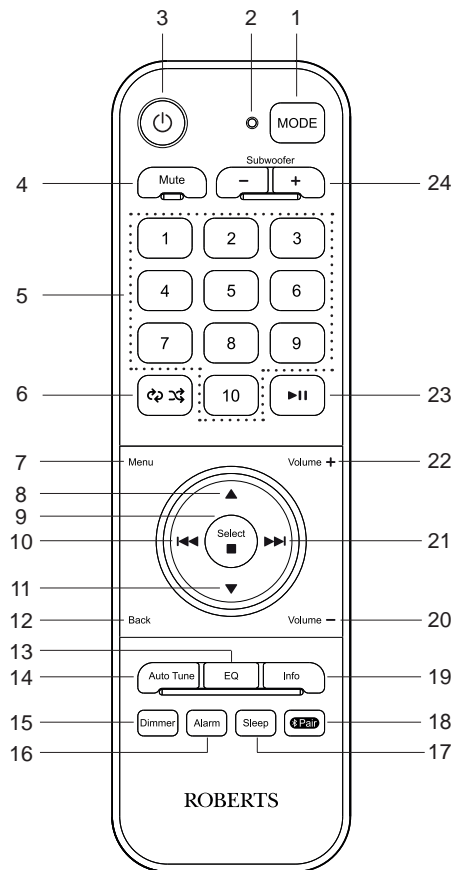

Remote control battery replacement

1. Remove the battery cover on the rear of your remote control by applying pressure to the catch in the direction shown by the arrow and then lifting off the cover.
2. Insert 2 x AAA size batteries into the spaces in the compartment. Take care to ensure all batteries are inserted with the correct polarity as shown inside the battery compartment.
3. Replace the battery cover.
4. If the remote is not to be used for an extended period of time it is recommended that the batteries are removed.

IMPORTANT: The batteries should not be exposed to excessive heat such as sunshine, fire or the like. After use, disposable batteries should if possible be taken to a suitable recycling centre. On no account should batteries be disposed of by incineration.

Do not leave batteries within reach of young children. They can be a choking hazard. If swallowed seek medical attention immediately as this can cause internal injuries that can be fatal.

Caution: Replace batteries only with the same or equivalent type. Danger of explosion if the batteries are incorrectly replaced.

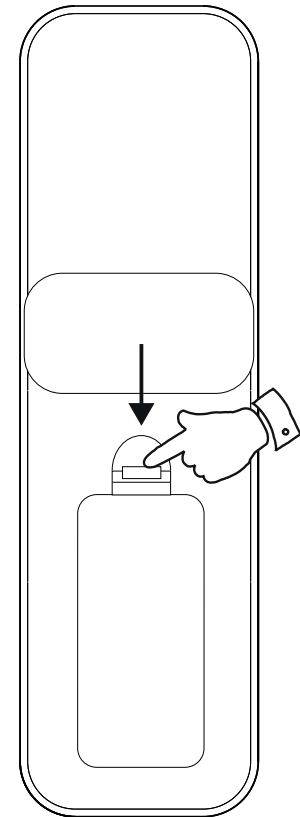

Navigation controls

This page describes the basic means of controlling your Stream 67 audio system. Instructions for each operating mode are given in the later sections of this book.

1. Press and release **On/Standby** to switch your audio system on or off.
2. Pressing the **Mode** button gives you access to each of the operating modes in turn. Alternatively **apply a long press** on the **Mode** button and then use the **Menu Left** or **Menu Right** buttons (on the remote control) or turn the **Tuning/Select** control (on the unit) clockwise or anti-clockwise to highlight the desired menu item then press **Select** to select that item.
3. Pressing the **Menu** button will access the menu system.
4. Many operations require the user to make a selection from the menu. This is done using the **Menu Up** or **Menu Down** buttons (on the remote control) or the **Tuning/Select** control (on the unit). Press **Select** to select that item.

If there are more than six items in a menu, then the display will automatically scroll up or down so that the additional items become visible. A sliding bar on the right will give an indication showing the current portion of the menu that is displayed. If there are many items in a menu, then the audio system allows the menu to 'wrap around' in either direction. This can make it easier to reach items at the end of a long menu, such as a list of countries or Internet radio stations.

5. If an error is made when navigating the menus, it is generally possible to go back to a higher level menu by pressing the **Menu** or the **Back** button.
6. The **Info** button allows the display of information relating to the radio station or music file being played.

Note: In this booklet, press always means **press and release**. If it is required to give a long press on a button this will be described as **apply a long press** and the button should be held down for 2 to 3 seconds until the audio system has responded.

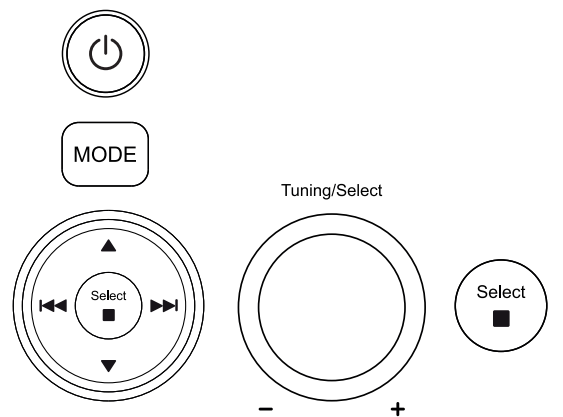

Menu

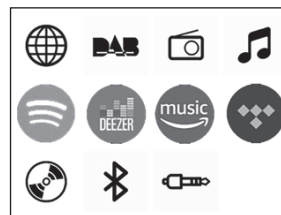

Menu

Back

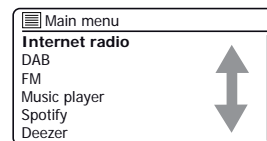

Plugging in and language selection

Your audio system may be configured using either the display and buttons on the audio system, or by using the UNDOK app.

1. Place your audio system on a flat surface and plug the mains lead into the mains socket located at the rear of the audio system ensuring that the plug is pushed fully into the socket.
2. If you wish to use a wired network connection, plug the Ethernet cable into the RJ-45 socket at the rear of the audio system.
3. Plug the other end of the mains lead into a wall socket and switch on the socket.

IMPORTANT: The mains plug is used as the means of connecting the audio system to the mains supply. The mains socket and any multi-way mains block used for the audio system must remain accessible during normal use. In order to disconnect the audio system from the mains, the mains plug should be removed from the mains socket outlet completely.

4. When you apply power, the display on the audio system will light up and show a start up screen for a few seconds.

If this is the first time that you use your audio system (or after a Factory Reset) the display will show the language menu.

5. By default your audio system will display all menus and messages in English. Press **Menu Up** or **Down** to highlight the desired language. Press **Select** to enter the selection. 'Setup wizard' and 'YES' will be highlighted on the screen.

Note: If you wish to use UNDOK to setup your audio system, please see [page 18](#).

6. If you would like to setup your audio system using the audio system's controls instead of the UNDOK app then press **Select** to select 'YES' and to begin setting up your audio system.

Continue on the next page.

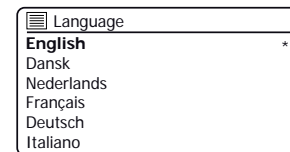
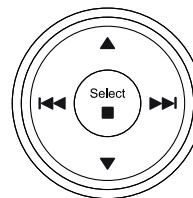
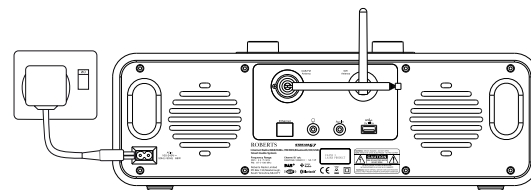

Clock and time settings

The following instructions assume that you have just plugged in and you have just specified the language option for the menus ([see page 10](#)).

1. Press **Menu Left** or **Right** to highlight the desired clock format (either 12 or 24 hour) then press **Select** to enter your selection.
2. Next, the way in which the audio system updates its clock is set. A menu allowing you to specify the auto-update option for the clock will be shown. The 'Update from Network' option will be best for most users.
3. Press **Menu Up** or **Down** to choose an auto-update option for the clock. This can be updated from DAB or FM radio, from the Network, or not updated automatically. The default is to auto-update from the network. If you choose another option go to ['Connecting to your computer network' on page 12](#). Otherwise you will first need to select the correct time zone and daylight savings setting, see the next steps. If you choose 'No update' you will need to set the [clock manually later, see page 60](#). Press **Select** to confirm your choice.
4. Press **Menu Up** or **Down** to highlight the time zone for your current location. Press **Select** to enter the setting.
5. You will then need to set the Daylight Savings option according to your location (Daylight Savings is also known as Summer/Winter time or BST/GMT adjustment).
Press **Menu Left** or **Right** to highlight 'ON' or 'OFF' as required. The asterisk shows the current setting. Press **Select** to enter the setting.
In the UK, 'ON' is equivalent to British Summer Time and 'OFF' is equivalent to Greenwich Mean Time.
6. Continue setting up your audio system on the next page.

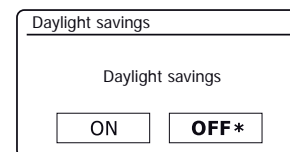
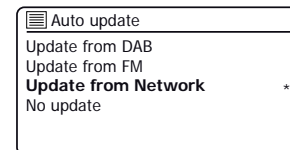
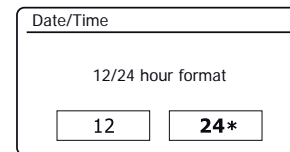
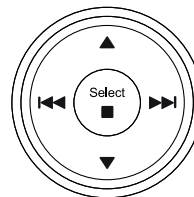

Before you can use your Stream 67 audio system to listen to Internet radio or to music streamed from your computer, it must first be connected to your computer network.

This section of this book describes how to connect the audio system to your network using either the wireless (WiFi) connection or the wired (Ethernet) connection.

The following instructions assume that you have just set up the clock and time options using the Setup Wizard as described on the preceding page.

These instructions also apply to the Network Wizard in the Network Settings menu (from step 2 onwards).

1. After setting the [Daylight Savings options \(see page 11\)](#), the display will show the 'Keep network connected?' option. You should choose 'Yes' if you wish to keep the audio system connected to the network when it is in Standby mode. This will allow remote control software to switch on your audio system when needed.

If you choose 'No' then your audio system will shut down its WiFi connection when it is in Standby, DAB, FM, Bluetooth, CD or Aux-in modes. This minimises power consumption but it does mean that you will need to switch the audio system on manually in order to use either Spotify Connect, the 'Play to / Cast to Device' function or any remote control software such as the UNDOK app.

Press **Menu Left** or **Right** to highlight the required option and then press **Select** to make the selection.

After setting the Keep Connected option, the display will show a list of supported WiFi regional options.

Press **Menu Up** or **Down** to highlight the required region (for the UK choose 'Europe'), and then press **Select** to make the selection. Do this even if you are planning to use the wired Ethernet connection. Your audio system will then scan for available WiFi networks.

2. The audio system will enter the Network Settings Wizard and will display 'Scanning...'. The audio system will automatically scan both 2.4GHz and 5GHz WiFi bands. After a short while the display will show a list of the available WiFi networks. If you are intending to use the WiFi connection go to step 3 on the next page.

To use the Ethernet connection to your router (with automatic configuration), press **Menu Up** or **Down** to point to the '[Wired]' menu item. Press **Select** and the audio system will attempt to connect.

If your network allows automatic configuration (which is normal) the audio system will acquire a network address. The screen should say 'Connecting...', and then 'Setup wizard completed'. Press **Select** to exit the setup wizard and show the Main menu. You can then skip to paragraph 10 on page 15.

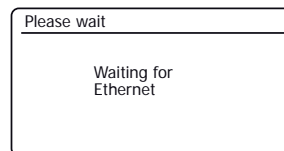
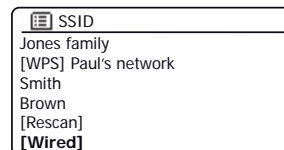
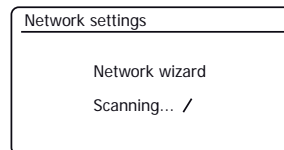
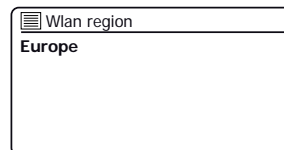
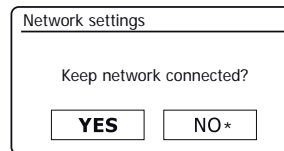

Connecting to your computer network - cont.

There are two indicator lights incorporated into the RJ-45 connector. If you have problems with your wired connection, they may help you to identify the possible cause of the problem.

Yellow ON = Link established; OFF = no connection

Green Flashing = Data transfer

If your network does not support automatic configuration or if you wish to set it up manually then you should select '*Manual config*' instead of selecting '*Wired*' in the Network Wizard, then go to page 17.

3. If you plan to use a WiFi connection, you will first need to identify your network in the list of network names presented by the Network Wizard. If no networks are found then you may have to get your wireless router working (please see the instructions supplied with it) or you may be too far from the router.

When the audio system finds your wireless network, it displays the Network Name (SSID) for the wireless access point on the screen. This is a name that is allocated to the access point in your router by the person who set up the network - for example: '*Jones family*' or '*Paul's network*'. Routers supplied by Internet Service Providers often have the default name of the WiFi network provided on a label or card for easy reference (e.g. BTHub-1234, virginmedia1234567). If the router supports WiFi Protected Setup, then '*WPS*' will be shown in front of the SSID.

It is possible, and in some locations highly likely, that your audio system will find more than one wireless network, in which case you should choose which one you need to connect to.

4. Press **Menu Up** or **Down** to see the SSID for each wireless network that has been found. If your network is shown proceed to step 6 on the next page. If it is *not* shown then proceed to step 5, also on the next page.

If you make a mistake at any point, use the **Back** button to go back to the previous screen.

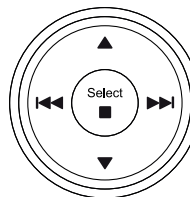
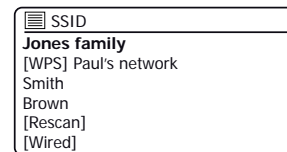
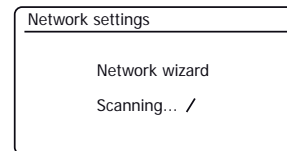
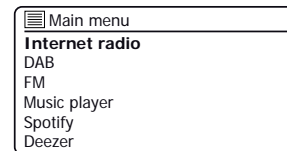
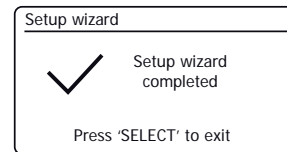

Back



- If your network is not found, it may be because the router is configured not to broadcast the SSID. You should then use **Menu Up or Down**, and **Select** to highlight and select the *'Manual config'* option in order to enter the network details manually. This is described in ['Manual Network Configuration'](#), see page 17. If your network name is being broadcast, and it was not found, then try re-scanning (press the **Back** button), and if necessary try moving your audio system to a location closer to your access point / router.
- When the SSID for the wireless network you wish to connect to is highlighted on the screen, press **Select**. If WiFi Protected Setup (WPS) was indicated, you will see an additional menu at this point, otherwise proceed to step 7.

Choose one of the WPS menu options as required for your router (WPS may be via push button, or using an identification number).

'Push Button' - the display prompts you to press the WPS button on your router and then **Select** on the audio system. The two devices should then connect with the encryption key sent automatically to the audio system.

'PIN' - the display shows an identification number which you must enter into your router using a web browser (refer to your router's user documentation). You should then press **Select** on the audio system. The two devices should then connect with the encryption key sent automatically to the audio system.

'Skip WPS' - if you wish to enter the encryption key yourself (or if it was previously entered).

If you chose Push Button or PIN the screen will then show *'Connecting...'* and then *'Setup wizard completed'*. Press **Select** to exit the setup wizard and then go to paragraph 10 on the next page.
- If your network is configured without an encryption key, the screen should say *'Connecting...'*, and then *'Setup wizard completed'*. Press **Select** to exit the setup wizard and show the Main menu. If this is the case then you have successfully connected your audio system to your network, so please go to paragraph 10 on the next page.
- If the screen displays *'Key:'*, it is because the network is using one of the encryption systems: Wired Equivalent Privacy (WEP) or WiFi Protected Access (WPA). You will need to enter the correct WEP or WPA key into the audio system to allow it to communicate with your wireless network. If you do not have the WEP or WPA key, then you should obtain it from the person who set up your network. Some wireless routers may come with an encryption key already set up by the supplier, in which case you should refer to the documentation provided with it. WPA is used here to also include WPA2.

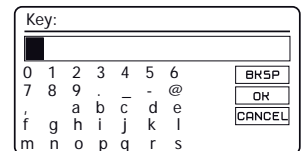
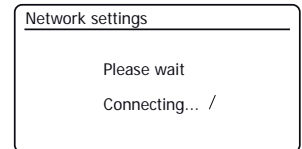
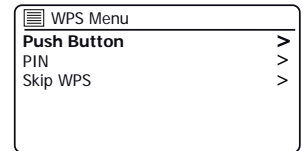
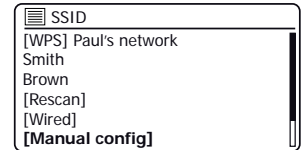
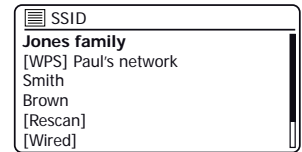

Connecting to your computer network - cont.

WEP keys are 10 or 26 characters long (using 0 - 9, and A - F). Some wireless routers can also use pass-phrases for WEP but these are not supported by the audio system. WPA keys are usually set up using a pass-phrase of between 8 and 63 characters. Your audio system accepts pass-phrases for WPA keys.

- To enter the WEP or WPA key, characters are selected and entered using **Menu Up** or **Down**, **Left** or **Right** and **Select** (on the remote control) or **Tuning/Select** on the unit. The highlight scrolls through the available characters as well as the three controls on the right. The character currently highlighted will be entered when you press **Select**. Do this as needed until the complete key has been entered. *Remember, WEP keys only use the numbers 0-9 and letters A-F. WPA keys are sensitive to upper and lower case characters. You must enter the key exactly or the audio system will not connect to the network.*

The three controls on the right-hand side of the screen have special functions. You can quickly access these by pressing the **Info** button and then using the **Menu Up** or **Down** and **Select** as needed:

- select **[BKSP]** to erase a character just entered (long press to clear); **Info** again to continue
- select **[OK]** when the complete key has been entered
- select **[CANCEL]** to cancel and re-run the Network Wizard

If a WEP or WPA key has previously been entered for the selected SSID then the display will show 'Key: [Set]'. If you have previously entered a different key, you must clear this by selecting the **[BKSP]** symbol. This will remove the '[Set]' indication.

After the final character of the WEP or WPA key has been entered, highlight the **[OK]** symbol and press **Select**. The screen will show 'Connecting...' and then 'Setup wizard completed'. Press **Select** to exit setup wizard. The audio system should now be able to connect to the network.

- Once you have connected your audio system to the network (and therefore also to the Internet) it will display the Main menu. Press **On/Standby** to put the audio system into Standby mode. It should then display the time as obtained from the Internet. If the time display is not correct for any reason, it can easily be adjusted later, [see page 60. 'Manually setting the clock'](#).

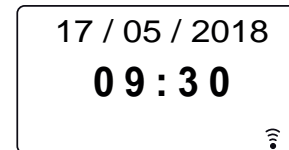
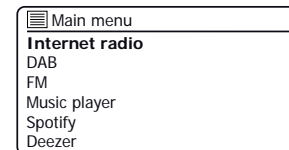
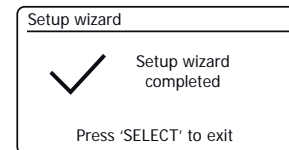
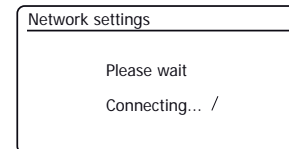
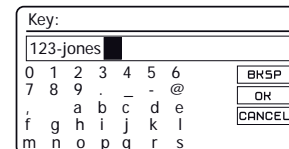
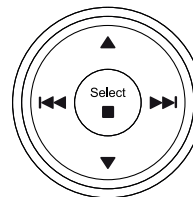

If you have followed the steps on the preceding pages successfully, your audio system will have connected to your router, and then made a connection to the Internet and set its clock. You can then listen to radio stations via the internet and use the other features of your audio system ([see page 22 onwards](#)).

Changing the network connection

In the sections above, you chose how your audio system would be connected to your network, either using a WiFi connection or using a wired Ethernet cable. From time to time, you may find that you need to connect to different computer networks. The Network Settings menu allows you to change your audio system's network settings, scan for an alternative wireless network, or to manually configure the network parameters.

The steps outlined below describe how you can do this - see also the section '[Network profiles](#)' on [page 82](#). If you have no need to do this, however, [please skip to page 22](#).

Configuring the audio system to use an alternative WiFi connection

1. From the Network Settings menu select '*Network wizard*'. This will present you with details of any WiFi networks that are found. Scroll down the list using **Menu Down** to the desired network name. Press **Select** to select this network.

The audio system will then use its WiFi system to communicate with the network. Depending on the settings for the new network you may need to [enter an encryption key \(see pages 14-15\)](#). By default the audio system will then acquire an IP address and other network settings from the network's router using DHCP (Dynamic Host Configuration Protocol).

Configuring the audio system to use the wired Ethernet connection

2. Connect your audio system to your router using an Ethernet cable plugged into the RJ-45 socket at the back of the unit. From the Network Settings menu select '*Network wizard*'. This will display a list of any WiFi networks that are found. Scroll down the list and select the '*Wired*' option.

The audio system will then use its Ethernet connection to communicate with the network. By default the unit will then acquire an IP address and other network settings from the network's router using DHCP (Dynamic Host Configuration Protocol).

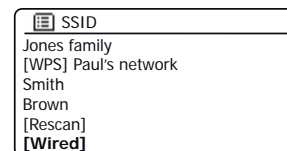
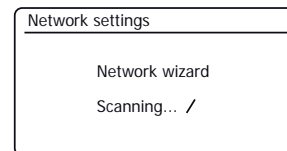
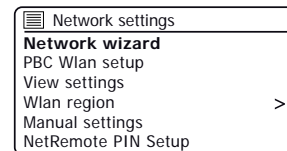
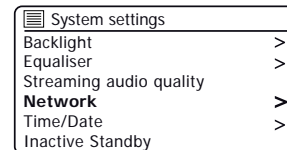
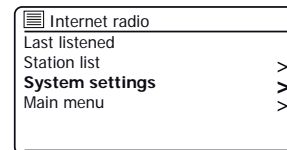

Manual network configuration

If you do not wish to use DHCP for automatic network configuration, or if your network is configured with a hidden SSID, then you will need to enter some network settings manually. The typical user will not need to use manual network configuration. The facility is provided to allow the product to be used with networks where the configuration of devices is not managed by the router, or where customised settings may be required. In such cases it is assumed that the user already has sufficient knowledge to understand the terms and settings used for this purpose. IPv4 address schemes are used.

- From the audio system's Network Settings menu, select '*Manual settings*'. You must then choose whether to connect using '*Wired*' or '*Wireless*' connections. If you choose '*Wireless*' there are as many as nine settings screens, shown by the '*1 of 9*' progress marker in the top right corner of the display. If you choose '*Wired*' there are five screens and the progress marker will reflect this, although the steps to set up the network parameters are basically the same.

- The subsequent menus allow configuration of the following parameters:

DHCP - On or Off

IP address - e.g. 192.168.1.25

Subnet mask - e.g. 255.255.255.0

Gateway address - e.g. 192.168.1.1

DNS address (primary and secondary addresses)

SSID - needed for WiFi connections if the SSID is not broadcast

WEP / WPA / WPA2 key and settings

When entering numbers, the SSID or the WiFi pass key, the three controls on the right-hand side of the screen have special functions. You can quickly access these by pressing the **Info** button and then use the **Menu Up** or **Down** and **Select** as needed:

select '**BACKSP**' to erase a character just entered (long press to clear); **Info** again to continue

select '**OK**' when the complete encryption key has been entered

select '**CANCEL**' to cancel and go back to the TKIP / AES options screen

- Upon completion of the settings the audio system should connect to the network. If the connection is made successfully, the audio system will return to the Network Settings menu. If the unit cannot connect, then it will display a '*Failed to connect*' message. You will then need to identify which setting may need to be changed, or whether some other network issue is responsible. Once connected, the network settings are saved. They are retained in memory while the audio system is disconnected from the mains.

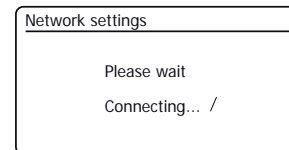
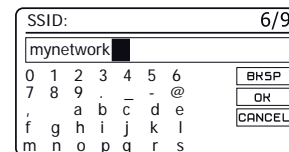
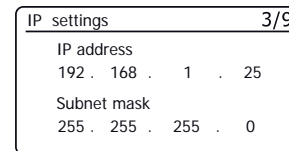
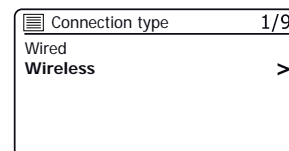
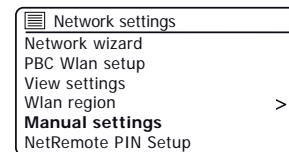

Configuration - Using the UNDOK app

Download the UNDOK app

Download and install the UNDOK app on to your Android or iOS device.



- iOS - Download from Apple App Store
- Android™ - Download from Google Play



- If you already have the UNDOK app installed on your device ensure that you have the latest version.
- It is possible that this app may have been changed slightly since these instructions were written.
- Please refer to the Roberts Radio website for guidance on how to use the latest version.

Note: At the time of writing Android version 4.0.3 and later or iOS version 9 or later are required to use UNDOK.



Setup new audio system - Apple iOS device

If your device uses [Android](#), please see [page 20](#).

The **UNDOK app** has a setup wizard to help configure suitable audio devices to connect to your home WiFi network.

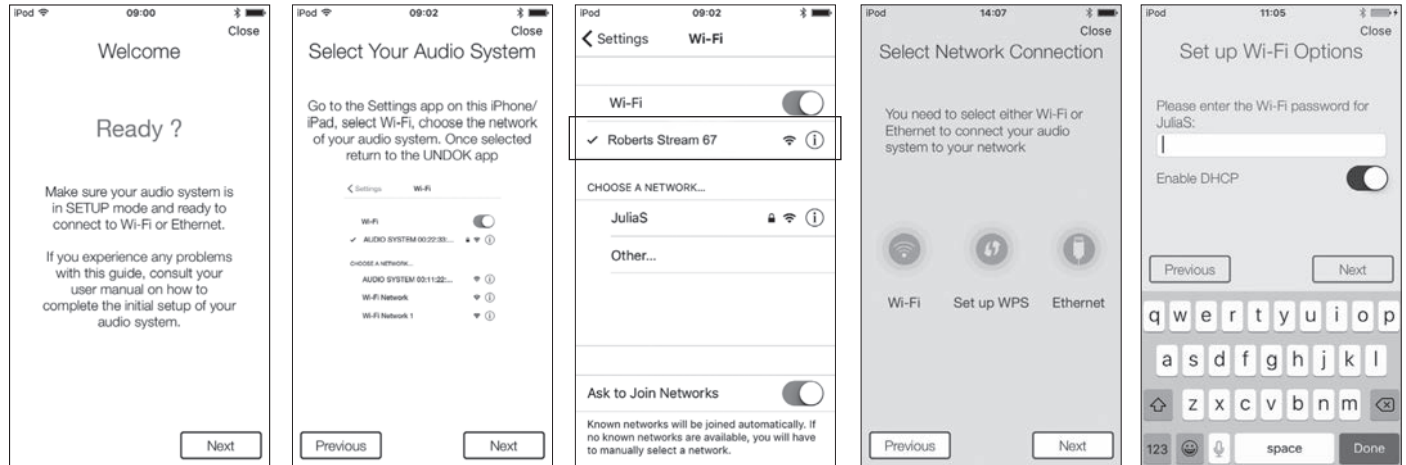

1. Open the **UNDOK app**.
2. Setup a **New Audio system**.
3. The app will prompt you to use your **device's WiFi** settings to connect to your audio system.
4. Select your **Stream 67** audio system. Once your device has connected to the audio system, **return** to the UNDOK app.
5. Use the app to complete the setup, including giving the unit a name whether it is connected by WiFi or Ethernet. If you wish to connect using an ethernet cable please see page 10.
6. For a WiFi connection the app will ask you to choose a WiFi network and enter the appropriate password.
7. Your audio system will connect to your network.



If your device is an [iPhone or iPad \(i.e. uses iOS\)](#) please see [page 19](#).

The **UNDOK app** has a setup wizard to help configure suitable audio devices to connect to your home WiFi network.

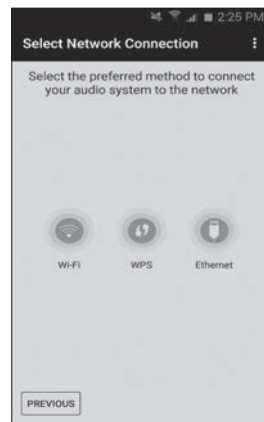
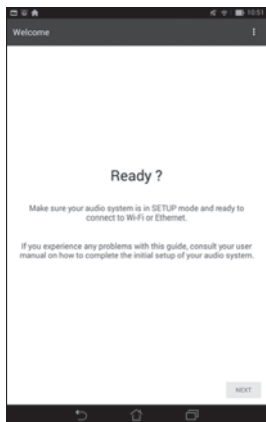

1. Open the **UNDOK app**.
2. Setup a **New Audio system**.
3. The app will show a list of suggested audio systems to setup.
4. Your audio system will normally appear in this list as **Stream 67**. It may appear in the list below called **Other**. Select the unit to be setup.
5. Use the app to complete the audio system setup, including giving the audio system a name.
6. Choose whether it is connected via WiFi or Ethernet. If you wish to connect using an ethernet cable please see page 10.
7. For a WiFi connection the app will ask you to choose a WiFi network and enter the appropriate password.
8. Your audio system will connect to your network.

Note: If when setting up your audio system your Android device complains that it cannot connect to the internet this is because it is temporarily connected directly to your audio system. You should ignore this warning message.



Network remote control options

Network PIN setup (PIN number)

Your audio system has the option of being controlled by an application installed on an Apple iPhone, iPod touch, iPad or equivalent Android device. The PIN number facility allows you to ensure that your audio system can only be controlled by your own device rather than someone else's.

The remote control application is called UNDOK, by Frontier Silicon Limited, and is available from the Apple App Store and Google Play for your device.

UNDOK will try to use the default PIN of '1234' to control your audio system.

You may change the PIN if desired using the 'NetRemote PIN Setup' option in the Network settings menu. The updated PIN should then be used in the UNDOK app to allow the app to reconnect to the audio system. The app will prompt you for the PIN as needed.

Keep network connected

Your audio system has the option to shut down its WiFi or Ethernet connection when it is in Standby. This minimises power consumption but it does mean that you will need to switch the audio system on manually in order to use either Spotify Connect, the 'Play to / Cast to Device' function or any remote control software such as the UNDOK app.

If you need to be able to remotely control the audio system even when it has been put into Standby, then you can choose to keep the network connected by using the 'Keep network connected' option in the network settings menu. In the Standby mode display the WiFi signal indicator is shown with or without a cross through it, or the Ethernet connection indicator is shown unplugged or plugged in, according to the state of the connection.



Control via the UNDOK app

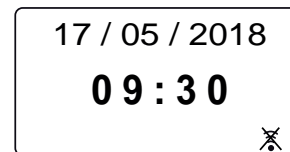
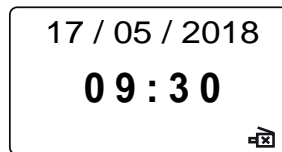
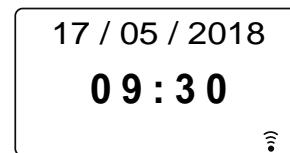
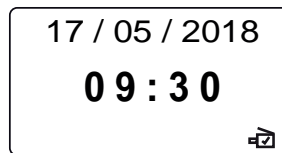
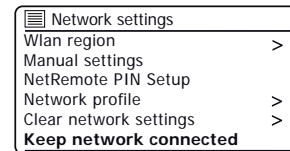
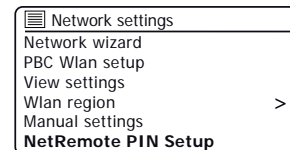

Internet Radio

Internet Radio - the basics

Before you can use your audio system to listen to broadcasts via the Internet, it is necessary to have connected it to your computer network using the wireless (WiFi) connection or the wired Ethernet connection (RJ-45 socket) located on the back of the unit. [Please see page 10 for details.](#)

There are literally many thousands of radio broadcasts available via the Internet as well as 'Podcasts'. Your audio system provides several ways of searching for broadcasts in order to make finding and choosing them easier. Once you have found the radio stations that you like, you may store them as presets within the audio system. The audio system allows you to store up to 10 presets.

You may search for an Internet radio station by Location. If you know the name of the station and the country from which a station is broadcast this may be the easiest method to find a station. It is also a great way to experience radio from other parts of the world.

You may also search for an Internet radio station by Genre. If you prefer a particular type of music, Blues for example, you may search for a radio station that broadcasts that type of music, and you can choose from a list of Blues radio stations regardless of location, or taking location into account.

If you know part of the name of an Internet radio station, you can enter it into the audio system and it will search for stations that match that name. This can be helpful if you are unsure of the location or genre of a particular station.

The Stream 67 audio system connects to a radio station database which serves many users in many countries. This means that there is a very wide range of programme content available. You can also search for stations which have been recently added to those available (new stations) or you can search for the most popular.



Internet radio



Selecting a radio station by location

1. Press **On/Standby** to switch on the audio system. Press **Mode** until Internet Radio is selected.
2. Press **Menu**.
3. Choose 'Station list', 'Stations', 'Location', and then scroll the list of continents then countries in either direction. Choose a radio category.

Note that the menu may offer one or more local selections based upon the country in which the radio is being used, according to your internet IP address ('United Kingdom' and 'BBC' stations, for example).

4. Highlight your chosen radio station or Podcast. Press **Select**.

If the audio system is unable to connect to a particular radio station this may be for one of the reasons explained in ['troubleshooting' page 85](#).

Selecting a radio station by Genre

1. Press **Menu**. Choose 'Station list', 'Stations', 'Genre', and then scroll the list of content types in either direction. Choose the desired genre.
2. Choose either 'Highlighted Stations' or a list of countries.
3. Highlight your chosen radio station. Press **Select**.

Searching for a radio station by name

1. Press **Menu**.
2. Choose 'Station list', 'Stations' then 'Search stations'.
3. To enter the search word(s) press **Menu Up** or **Down**, **Left** or **Right** to highlight each character for the search in turn, and press **Select** to enter. If you make an error use **Info** to access the delete character 'BKSP' on the screen and then press **Select**. Press **Info** again to go back to the character selection. After the final character of the search has been entered, use **Info** and then **Select** to highlight the 'OK' symbol on the screen and then press **Select** to finish.



Menu

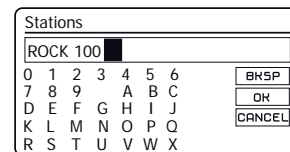
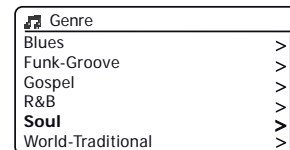
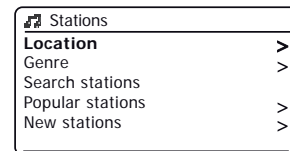
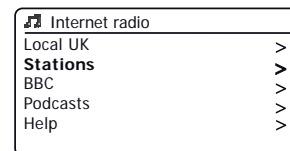
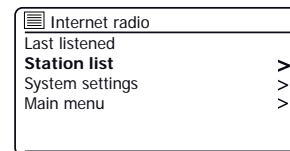
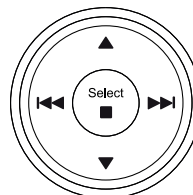
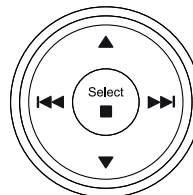

Selecting a new or popular station

Your audio system connects via the Internet to a database of radio stations. This option is provided to highlight stations which are newly added to the list of those available, or stations which are particularly popular with listeners around the world.

1. When in Internet Radio mode press **Menu**.
2. Choose 'Station list', 'Stations' and then 'Popular stations' or 'New stations'.
3. Highlight your chosen radio station. Press **Select**.

Selecting a podcast

Radio broadcasters and individuals may make programmes which are intended normally to be downloaded into a computer or copied onto a portable media player. These are commonly known as Podcasts. Podcasts are also accessible using the [Podcasts option on the Stations menu \(see page 23\)](#).

1. When in Internet Radio mode press **Menu**. Choose 'Station list' and then 'Podcasts'.
2. You may then search by location, genre, or using part of the name of the podcast. The searches operate in exactly the same way as when searching for a conventional radio station.
3. Stations which enable you to listen to previously broadcast programmes may allow you to fast-forward, rewind to any point within a programme and play or pause.

Note: These features are dependent on the programme or podcast and will not always be available.

Last Listened

The 'Last Listened' feature provides you with quick access to the ten most recently listened to radio stations or podcasts. As each new radio station is listened to the oldest item is deleted from the list. The Last Listened list is stored when the audio system is disconnected from the mains.

1. When in Internet Radio mode, press **Menu** and then choose 'Last listened'.
2. The display will then show a list of the last ten Internet radio stations or podcasts. Highlight whichever you wish to listen to and then press **Select** to cause your audio system to reconnect to that radio station or podcast.

Menu

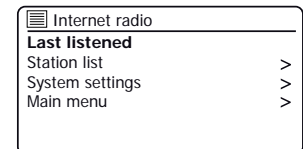
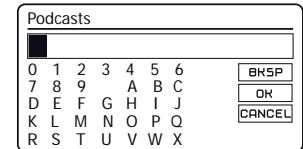
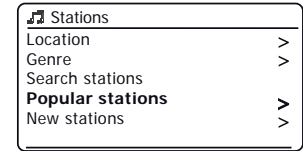
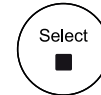
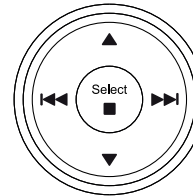

Presetting stations Internet radio, DAB and FM

Your audio system has 10 memory presets for Internet radio, 10 DAB and 10 FM which can easily be set to store the details of any radio station or (for internet radio a podcast).

The radio station presets are retained even when the audio system is switched off.

For internet radio only, please see also the sections ['Last Listened' on page 24](#).

Storing a preset (1 - 10) using the remote control

1. Switch on your audio system and tune to the required Internet Radio, DAB or FM station.
2. **Apply a long press** on the required **Preset** button (1-10) on the remote control until the display shows *'Preset stored'*.

Repeat this procedure as needed for the remaining presets.

3. Stations which are already stored in the presets may be over-written by following the procedure above.

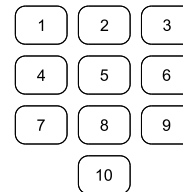

Recalling a preset (1 - 10) using the remote control

1. Switch on your audio system.
2. Select the required mode (Internet Radio, DAB or FM) using the **Mode** button.
3. Momentarily press and release the required preset button (1-10) on the remote control.
4. Your audio system will then connect to the station stored in the preset memory. The preset used will be shown at the bottom of the display screen.

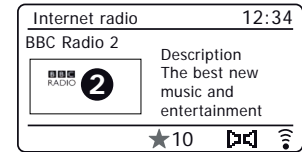
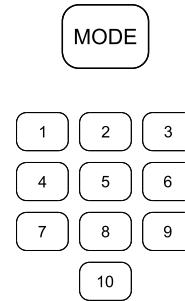

Storing a preset (1 - 10) using the menu

1. Switch on your audio system and tune to the required Internet Radio, DAB or FM station.
2. **Apply a long press** on the **Preset** button on the unit. The display will show a 'Save to Preset' menu.
3. Use the **Tuning** control to scroll through the preset list until you reach an unused preset or a preset that you wish to change.
4. Press and release the **Tuning/Select** control to store the preset. 'Preset stored' will be shown on the display.

Repeat this procedure as needed for the remaining presets.

5. Stations which are already stored in the presets may be over-written by following the procedure above.

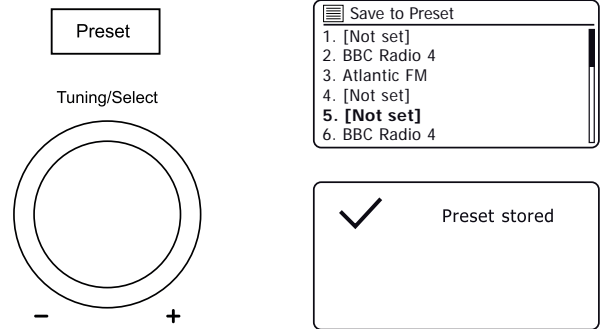

Recalling a preset (1 - 10) using the menu

1. Select the required mode (Internet Radio, DAB or FM) using the **Mode** button.
2. Press and release the **Preset** button to display the 'Recall from Preset' menu.
3. Use the **Tuning** control to select the desired preset station. Press and release the **Tuning/Select** control.

Your radio will then connect to the station stored in the preset memory.

Note: You may select a stored preset by pressing the **Previous** or **Next** button. The preset used will be shown at the bottom of the display screen.

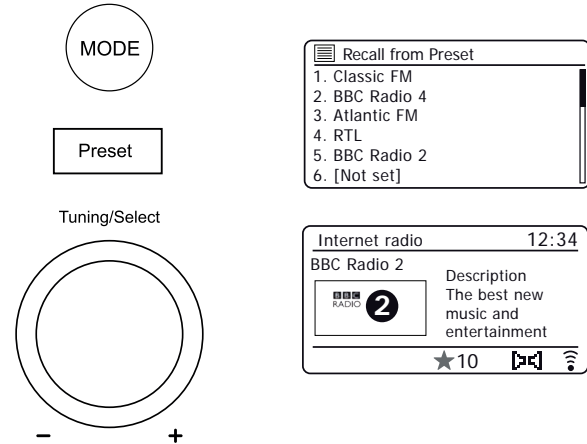

Display options - Radio / Bluetooth / Music Player

Your audio system has a range of display options when in Internet Radio, DAB, FM, Bluetooth and Music Player modes.

Press the **Info** button to cycle through the various options.

When images are displayed (station logos, album art) they may be displayed full screen by pressing **Select**. Press **Select** again to exit.

Internet Radio display options

Description, genre, reliability, format, playback buffer, date.

Additional or alternative information may be displayed when listening to Podcasts.

DAB Radio display options

Station name, scrolling text, program type, multiplex name, channel & frequency, signal strength / error rate, bit rate, audio type and date.

For the signal strength/error rate a low error number indicates a better quality of DAB radio signal. The minimum signal marker 'I' which separates the left and right parts of the signal graph shows the minimum signal level required for satisfactory reception.

If a DAB radio broadcast provides a slideshow image, this may be viewed full screen by pressing **Select**. Press **Select** again to exit.

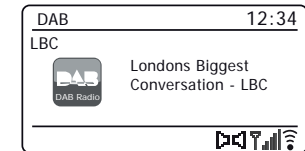
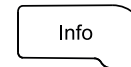
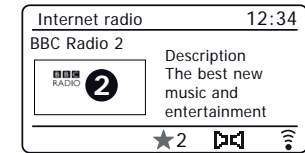
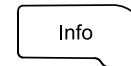
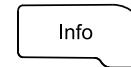

FM Radio display options

Station name, scrolling text, frequency, program type and date.

In FM mode your radio can use the Radio Data System (RDS) to display the radio station name and additional text when provided by the broadcaster and where the radio signal is sufficiently clear.

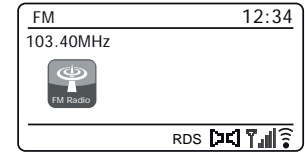

Bluetooth display options

If your connected device is able to provide information from the track being played, your audio system can display the following in Bluetooth mode:- Title, album and artist details.



Music Player display options

Progress bar, artist, album, format, buffer and date details.

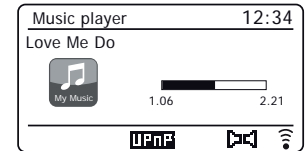
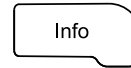

Music Player

Use with Windows, Apple Mac, Linux, USB memory

The Music Player allows you to play audio files which are stored on another device connected to your network or which are held on a USB memory device plugged into your audio system.

Networked devices that could hold audio files can include computers, smart phones, tablets, Network Attached Storage (NAS) units, and network routers which have UPnP / DLNA file sharing capability. In order to play files from a device on your network, your audio system must connect to a file server program on that device which uses the Universal Plug and Play (UPnP) protocol (often known as DLNA).

If the device is a computer or tablet using Windows, then it probably already has a UPnP server program available in the form of Windows Media Player (WMP). This allows you to share your files to devices on your network, and you may then select files by Album, Artist, and so on using your audio system's controls. WMP can serve MP3, WMA, AAC and WAV files to your audio system (and FLAC files from Windows 10).

If you are an Apple MacOS, Linux, iOS or Android user, or if you have your audio files stored in other formats, such as ALAC, there are many other UPnP server programs available. Note that Apple computers do not support UPnP streaming natively and third party software is required for this task. If you wish to use a DLNA server built into your network router, you should consult your router's documentation on how this should be configured.

The Music Player on the audio system can play audio files in MP3, WMA, AAC, ALAC, FLAC and WAV formats. WMA Lossless files can also be played when using Windows Media Player as the UPnP server. Note that the playback of files encoded using WMA Voice, WMA 10 Professional, and of files which have DRM protection is not supported by the unit.



Please note that when using a UPnP/ DLNA server, the search and selection criteria that are available to the user are determined by the server software, and not by the device playing the

content. Typical searches include Artist, Album and Genre. Many server applications also allow you to access your files according to the folders within which they are stored as well as other criteria. Windows Media Player is less flexible than some other UPnP servers in this regard, but is generally easier to set up.

Many UPnP server applications are also capable of sharing pictures and video files to other network connected devices. If this is the case (as it is with Windows Media Player) you may see the option of choosing between 'Music', 'Video' and 'Pictures' on the Music Player's menu. Clearly you should only select the 'Music' option. Content offered via the alternative options will not be playable on your audio system.

Some third party server applications allow customisation of the search criteria and indexing methods. This can be useful if you have a very large collection of stored music files.

It is not possible in this book to describe server applications for all available environments, and neither is it practical to describe how to get the best out of each. Windows Media Player is used as an example in this case, although many of the principles are applicable to other servers as well. The access to the media, the choice of media for playing, and the use of the media playback controls from the product or from its controlling app are similar regardless of the UPnP / DLNA server being used.

[When using your unit as part of a group of multi-room products, audio files in ALAC and FLAC formats will only play on the group master \(see page 86\).](#)



Accessing your audio files via a UPnP server

If your computer is running Windows 7, 8, 8.1 or 10, then Windows Media Player includes a UPnP server which will make your files available to your audio system. There are other UPnP server solutions available for non-Windows users and for Windows users who may wish to use an alternative (see the preceding page).

It is beyond the scope of this instruction book to cover all possible options for UPnP. We explain the use of Microsoft's Windows Media Player here since that will be the first choice for the majority of users.

Set up UPnP access with Windows Media Player

1. At the time of writing, Windows 7, 8, 8.1 and 10 all use Windows Media Player version 12 (referred to here as WMP 12), and the configuration is similar in each case. WMP 12 can create a library from all the media files available to it on your PC. To add new media files to the library, select 'Library', then 'Music', then 'All music' or 'Artist', 'Album' etc. This will show you the current library contents. You may then simply drag and drop files from other locations into the library. Alternatively, with media files or folders on the screen, you may right-click on the file or folder and select 'Include in library' and then select 'Music'. In this way you can quickly add additional content to your music library.
2. In WMP 12, click on 'Stream' (see picture at right) and then select 'Automatically allow devices to play my media'. Then accept the 'Automatically allow all computer and media devices' option. There are other options (see overleaf) but this is the simplest if you just wish to quickly enable media streaming to your audio system.
3. Switch the audio system on and press **Mode** until the 'Music Player' mode is shown. The main music player menu will then be displayed.

Enabling Media Streaming in Windows Media Player 12

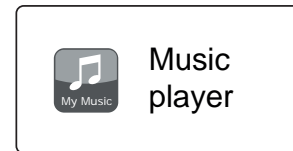
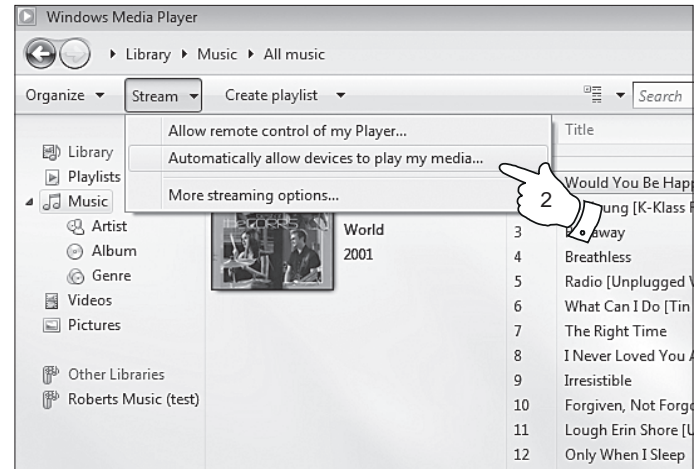

Set up UPnP access on a Windows PC - cont.

- Press **Menu Up** or **Down** until *'Shared media'* is highlighted and press **Select**. The audio system will scan for all available UPnP servers. It may take a few seconds for the audio system to complete its scan. The audio system will display '<Empty>' if no UPnP servers are found.

- After scanning, select your UPnP server. If you allowed automatic connection previously, your audio system should now connect and you may skip to the next page.

If you did not permit automatic connections, your audio system will then normally display *'Unauthorised'* at this stage.

- Your PC may prompt you that there has been a connection to your UPnP server. Whether prompted or not, in order that the audio system may access the music files, you will need to click the *'Library'* tab in WMP 12 and select the *'Stream...'* item to open the *'Media Streaming'* window. Select *'Automatically allow devices to play my media'* then select *'Automatically allow all computer and media devices'*.

Alternatively select *'More Streaming options'* to enable sharing on a 'per device' basis.

- In the *'More streaming options'* window, the unit may be listed as a blocked device. Click on the button shown to select *'Allowed'*.

Note: If you are using Microsoft's Windows' firewall software, this should be correctly configured by WMP 12. If you are using third party firewall software you may need to manually configure it to allow your unit and WMP 12 to communicate (see the ['Troubleshooting' section on page 85](#)).

- On the audio system, select the named server again. If WMP 12 is now able to communicate with your audio system you will be presented with some media selection options on the display.

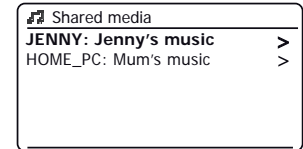
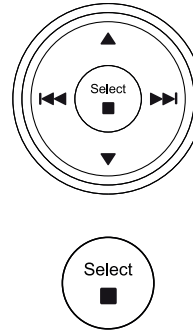

Allowing a device to connect to Windows Media Player 12

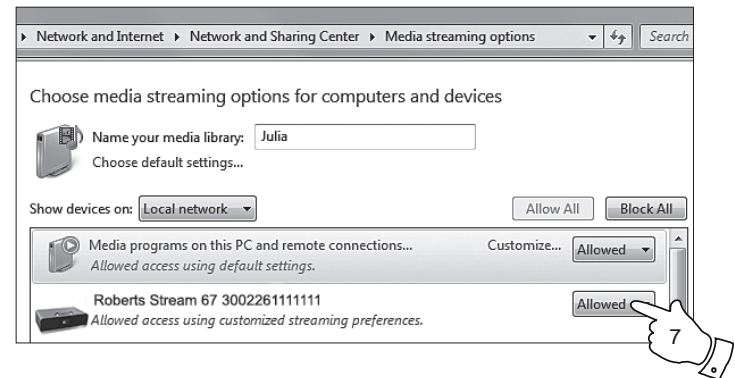

Locating and playing media files using UPnP

Once the UPnP server has been configured to share media files with your audio system, you may select the files that you wish to play as follows:-

1. Switch on the audio system. Press **Mode** as needed until the *Music Player* mode display is shown. The main Music Player menu will then be displayed.
2. Press **Menu Up or Down** until 'Shared media' is highlighted on the display and then press **Select** to cause the audio system to scan for UPnP servers. Note that it may take a few seconds for the audio system to complete its scan. The display will return to the Music Player menu if no UPnP servers are found.
3. After a successful scan, highlight your UPnP server and then press **Select**. If the display shows multiple media types, select 'Music'. (Some UPnP servers can serve pictures and video content to suitable devices.)
4. The audio system will now list the media categories which are made available by the UPnP server - for example, 'Album', 'Artist' and 'Genre'. Highlight which category you wish to browse, then press **Select** to confirm your choice.

If you wish to use the search function choose 'Search' on the display. You may select characters to build a keyword for searching for content to play.

When you first set up sharing with a UPnP server, not all of your files will be available immediately. The UPnP server must look inside each file to identify the artist and album information from 'tags' embedded in them. The server may also need time to access the Internet to obtain additional information such as 'album art' which it can display when you examine your music library on your PC. For a library of many files this can take some time.

Media selection

When searching via UPnP you will have a selection of search criteria as determined by the UPnP server software on your computer. This allows you to search by a given information type (Album, Artist, Genre, etc.) and then to narrow the search to an album or to a particular track within an album.

Some UPnP server applications allow the search options to be customised. The searches described here are just examples of the possibilities.

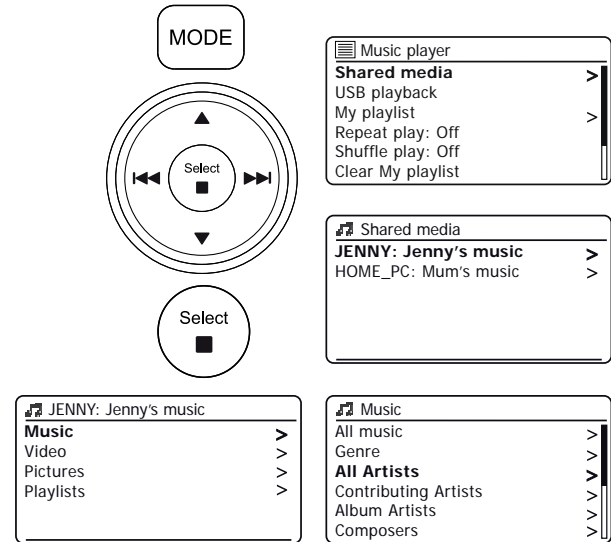

The Stream 67 is able to display the album art for the track being played. The ability of the audio system to display art depends on the presence of the art in the file being played, the art being not too large (or being re-sized by the server), and the ability of the UPnP server to send the art to the audio system. Art sent to the audio system needs to be in a JPEG format and no larger than 640 x 480 pixels. If the radio does not receive any art then a default icon is displayed. Some UPnP server applications will also send a default icon if no art is found within the file being played. Due to the wide variations in album art formats and UPnP/DLNA standards, the failure of the radio to display album art is not considered to be a fault.



Listening to a complete album

1. Press **Menu Up** or **Down** to choose content by Artist, Album, Genre, etc. according to your needs then press **Select** to enter your choice.
2. When you reach the album or folder the menu will then switch to showing the tracks in that album or folder. When searching by UPnP they will normally be listed in track number order (but as with the search criteria, this can vary according to the server application used).
3. With the first track in the album indicated, press **Select**. The album will then begin playing.

While the unit is playing from your media library, you may use the menus as described to choose a different selection. When you select the track from which to play, the unit will then immediately begin playing the new selection. [Please also see 'Playlists' on page 39.](#)

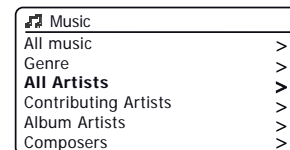
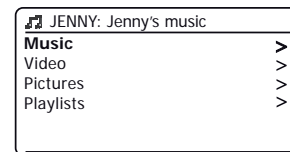
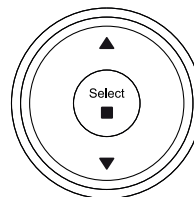

Listening to a particular track

1. If you wish to play only a particular track from an album or folder, first choose the album or folder as described on the preceding pages.
2. Press **Menu Up** or **Down** until the required track is highlighted.
3. Press **Select**. The track will begin playing. The audio system will then play subsequent tracks from the same album or folder.

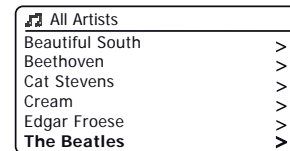

Controlling playback

1. Press **Pause** to pause playback of the current track.
2. If you press **Play**, playback will resume from the point where it was paused.
3. Press **Previous** to start playback of the previous track in the list.
4. Press **Next** to start playback of the next track in the list.
5. Press and hold the **Next** or **Previous** button to move through the current track. The longer the button is pressed, the greater the speed at which the player will move through the track. Release the button when the desired point is reached. (Note that this feature is not supported when playing files encoded using the FLAC and ALAC formats.)

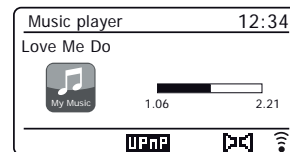
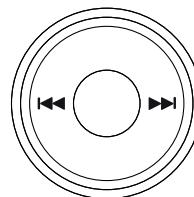

Controlling playback cont.

In the music player you may choose to repeat the current album (or playlist), or to play the files in random order, or both options together.

Repeat tracks

1. To enable or disable the Repeat option, press the **Repeat/Shuffle** button. The repeat icon will show on the display when repeat is enabled.

You may also control the options from the Main Music Player menu.

2. Press **Menu Up** or **Down** until 'Repeat play' is highlighted.
3. To activate the repeat option press **Select** so that 'On' appears on the display. Your selected tracks will now be played repeatedly and the **Repeat** icon will show on the display.
4. To turn off the repeat option highlight 'Repeat play' and press **Select** so that 'Off' appears on the display.
5. Press **Menu** to exit.

Play tracks in random order

1. To enable or disable the Shuffle option, press the **Repeat/Shuffle** button. The shuffle icon will show on the display when shuffle is enabled.

You may also control the options from the Main Music Player menu.

2. Press **Menu Up** or **Down** until 'Shuffle play' is highlighted.
3. To activate the shuffle option press **Select** so that 'On' appears on the display. Your selected tracks will be played in random order and the **Shuffle** icon will show on the display.
4. To turn off the shuffle option highlight 'Shuffle play' and press **Select** so that 'Off' appears on the display.
5. Press **Menu** to exit.

If both Repeat and Shuffle playback options are set to 'On' then both Repeat and Shuffle icons will be shown in the display.

Music Player



Menu

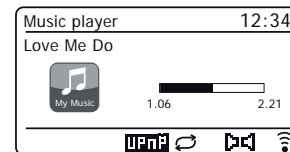
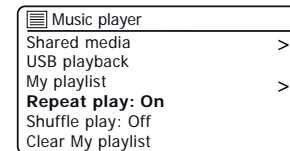
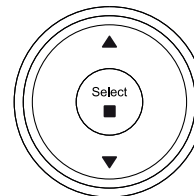

Menu

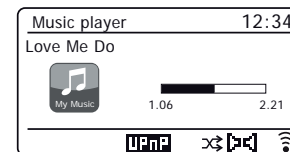
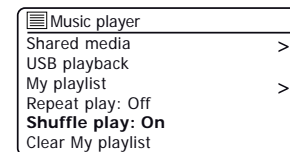
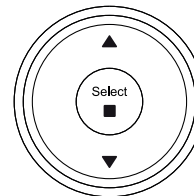

Using USB memory devices

This section describes how to use your audio system to access and playback your audio files via USB memory devices. USB memory devices plug into the rectangular slot on the rear of your audio system.

Important: Your audio system is only designed to work with USB flash memory devices. It is not intended to be connected to hard disk drives or any other type of USB device.

The Stream 67 has been tested with a range of USB memory devices of up to 256GB capacity. USB memory must use the FAT or FAT 32 filing system in order to operate with your audio system. Your audio system is unable to play from media formatted using the exFAT or NTFS formats.

It is possible to use SD, SDHC or SDXC cards for media storage and playback when held in a suitable USB adaptor. However, due to the wide variation of such adaptors, it is not possible to guarantee that all adaptor / card combinations will work in the audio system.

Audio formats supported are MP3, WMA, AAC, FLAC, ALAC and WAV.

USB playback does not support files encoded using WMA Lossless, WMA Voice, WMA 10 Professional, nor files of any format which have DRM protection.

Recommendations:

Unless you have only a few files on the USB memory device, do not place all files in the root folder.

The number of items (files / sub-folders) in any folder should be less than 2000.

Searching and playback will be more responsive if the number of files in any one folder is limited (we suggest not more than 250).

It is recommended that the USB memory is reformatted in your computer before adding your music files.

The maximum depth of folder nesting permitted is 8 folder levels (but playback is only from the currently selected level).

Shuffle and Playlist functions are limited to 500 tracks.

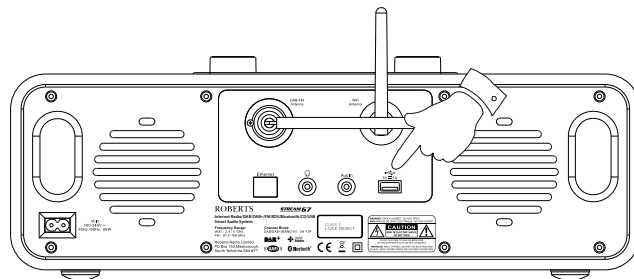

Cautions:

In order to minimise the risk of damage to your audio system or your USB memory, please place the unit so that the memory device cannot easily be knocked while it is inserted in the socket.

Remove the USB memory before carrying the unit or if not using the USB feature for a prolonged period.

Place the unit in Standby mode before removing your USB memory device.

The USB connection is intended only for flash memory devices. The use of hard disk storage media is not supported.

Playback via USB of files stored on MP3 players is not guaranteed.



Playing files from USB memory devices

1. Carefully insert the USB memory device into the USB socket on the rear of your audio system. Press **On/Standby** to switch the unit on.

The audio system may detect that the memory has been connected, in which case it will ask whether you wish to open the folder view of the memory contents. Press **Select** to select 'Yes' and skip to step 4 below.

If the USB memory was not automatically detected, proceed as follows.

2. To select USB playback mode press **Mode** as needed until the *Music Player* mode is selected. If needed press **Menu**.

3. Press **Menu Up** or **Down** until '*USB playback*' is highlighted on the display and press **Select**. The audio system will now list the content stored on the USB memory device. If there are many files or folders this may take a few seconds.

4. Press **Menu Up** or **Down** to highlight the required folder and press **Select** to enter the current folder. The list of tracks in the current folder will be displayed.

Alternatively, if you have nested folders (such as album folders within an artist folder) then you will simply step to the next folder level.

5. Press **Menu Up** or **Down** to select the track and press **Select** to begin playing from the highlighted track. All files in the current folder will then be played in turn.

Files are sorted by filename in numeric-alpha order (0 - 9 ... A - Z) before being played. Albums will play in the correct order if the filename begins with the track number (use leading zeroes if more than 9 tracks).

6. [Controlling playback from the USB memory device including Shuffle and Repeat functions is explained on pages 35-36.](#)

Music Player



Menu

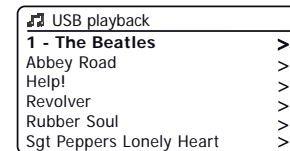
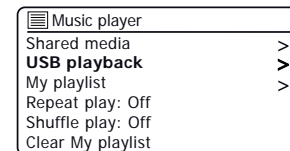
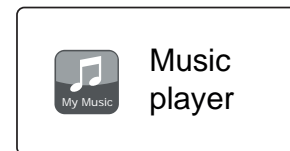
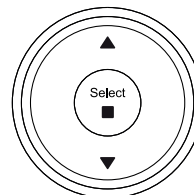

Playlists

You may wish to set up a list of music tracks or albums which can then be played as background music for a party, for example. Your audio system can be configured to hold a queue of up to 500 tracks in a playlist menu. The tracks or albums for the playlist can be selected from your UPnP server and from a USB memory device. The playlist is held in the memory in your audio system until the external power is removed, or until the playlist is cleared from the menu.

Adding a single track, entire album or folder to your playlist

1. When selecting (or when playing) a track using a UPnP server or a USB memory device **apply a long press** on **Select** and the display will show 'Added to My playlist'.
2. The track will be added to the playlist for playback later.
3. When using a UPnP server or a USB memory device highlight the chosen album, artist or folder and **apply a long press** on **Select**. The display will show 'Added to My playlist'.
4. Each of the tracks within the album, artist or folder selection will be added to the playlist individually. This allows any unwanted tracks to be removed from the playlist if needed (see below).

Viewing your playlist

1. Press **Mode** as needed until the *Music Player* mode is shown. If needed press **Menu**. The Music Player menu will then be shown on the display.
2. Choose 'My playlist' to enter the playlist.
3. Press **Menu Up** or **Down** to scroll through the playlist. Tracks which are served via UPnP will show their track name and USB tracks will show their file name.

Erasing a track from the playlist

1. Press **Menu** and then choose 'My Playlist'.
2. Press **Menu Up** or **Down** until the track you wish to erase is highlighted. **Apply a long press** on **Select**.
3. To delete the track highlight 'YES', then press **Select** to confirm the deletion. If you do not wish to delete the track from the list highlight 'NO' and press **Select** to cancel the operation.

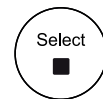

Menu

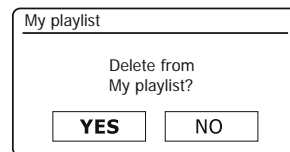
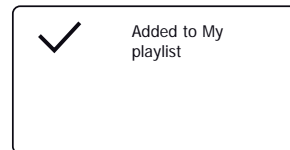
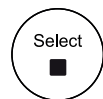
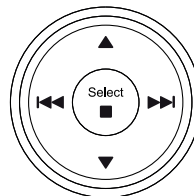

Clearing the playlist

1. Press **Menu**. To clear the whole playlist choose 'Clear My playlist' and then choose 'YES'. If you do not wish to clear the playlist choose 'NO'.

Playing your playlists

1. Press **Menu**. Choose 'My playlist'.
2. To play the playlist from a particular track, press **Menu Up** or **Down** until the desired track is highlighted then press **Select** to start play.
3. While playing from the playlist, you can use this function to jump to a particular track within the playlist. While playing from the playlist, you may add additional tracks or albums or remove specific tracks (please see the preceding page).

Prune servers

Your unit stores details of UPnP servers that it has seen via its network connection in its internal memory. If you use the audio system at different locations you may find that there are servers listed by the audio system that you are no longer interested in. The prune servers function allows only active UPnP servers on the currently connected network to be shown when selecting 'Shared Media' from the Music Player menu.

1. Press **Menu**. Choose 'Prune servers'. To remove servers that are no longer required choose 'YES'. If you do not wish to prune servers choose 'NO'.

Wake On LAN

If you are using a computer as a UPnP server for playing your music files via your audio system, you may not wish to keep that computer operating when you are not listening via your audio system. If your computer is suitably configured, it can either shut down, or enter a Standby or hibernation state when it is not being used.

Your audio system can wake up a computer which has shut down using a Wake On LAN command via the network provided that the audio system has previously connected to a UPnP server application on that computer. A computer which is not currently active will be shown with a question mark in the list of UPnP servers. Many computers will not respond to Wake On LAN commands from the audio system in all modes, and may require software, device driver, BIOS, hardware or router configuration changes for this function to operate. Failure of a computer to respond to Wake On LAN is not considered a fault of the audio system.

Menu

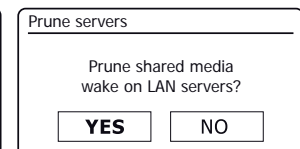
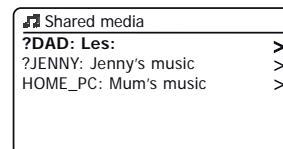
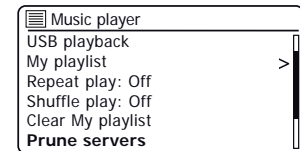
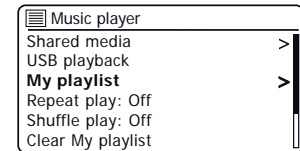
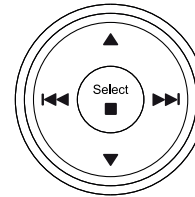

Keep network connected

Your audio system has the option to shut down its WiFi or Ethernet connection when it is in Standby. This minimises power consumption but it does mean that you will need to switch the audio system on manually in order to use either Spotify Connect, the 'Play to / Cast to Device' function or any remote control software such as the UNDOK app.

If you need to be able to remotely control the unit even when it has been put into Standby, then you can choose to keep the network connected by using the *'Keep network connected'* option in the network settings menu. In the Standby mode display the WiFi signal indicator is shown with or without a cross through it, or the Ethernet connection indicator is shown unplugged or plugged in, according to the state of the connection.

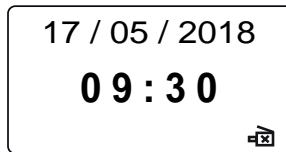
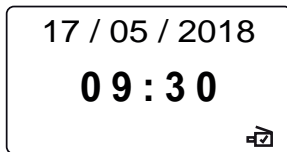
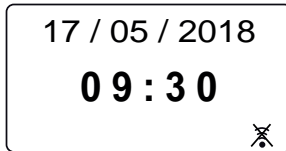
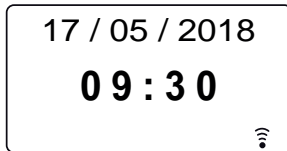
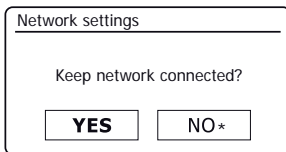
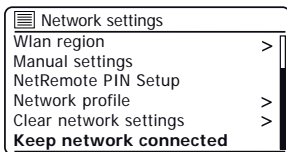

Windows 'Play to' / 'Cast to Device' function

If you use Windows 7, 8, 8.1 or 10 it is possible to choose a music album, track or playlist at the computer and then tell Windows that this should be played on the audio system using the 'Play to' function (called 'Cast to Device' in Windows 10).

Similar functionality is available for handheld devices using Apple's iOS or Android operating systems by using the UNDOK app. To use this feature, choose the 'Local Music' source option in the UNDOK app.

When used in this way the playing screen on the audio system will show the current operating mode as 'Local Music'. In this mode the audio system operates as a DLNA Digital Media Renderer.

1. In order to use the 'Play to' / 'Cast to Device' function, the audio system must be actively connected to the network. If your audio system is configured to keep its network connection in Standby mode (see 'Keep network connected', at left), then go to step 3.
2. If your audio system is not currently in use, or does not have an active connection to your network, then you should first switch on your audio system and select the Music player mode using the **Mode** button. Then select 'Shared media' from the menu so that the audio system establishes a connection with Windows Media Player on your PC. After this step, all other functions may be performed from your computer.
3. At your Windows PC, locate the file, album or playlist that you wish to play on the audio system.
4. Use the right-hand mouse button to pop-up a menu of options for the chosen item and select the 'Play to' / 'Cast to Device' option.
5. Windows should show you one or more devices, including your audio system, to which you may choose to send the music. Highlight the audio system item and click with the left mouse button.



- Windows will then open a 'Play to' / 'Cast to Device' window showing the track or tracks to be played. Your computer will then take control of your audio system. Your audio system will enter the 'Local Music' mode and after a few seconds the audio system will start playing.
- While the audio system is playing in 'Local Music' mode you can use the controls in the 'Play to' / 'Cast to Device' window on your computer to skip tracks, fast-forward or rewind, to pause or restart, and to change the volume on the audio system.

You may also use the controls on your audio system to adjust volume, display track information (press the **Info** button) or to change operating mode. It is not possible to skip tracks or pause playback using the audio system's controls while it is in 'Local Music' mode.
- While playing, you may select additional content within Windows and again use the 'Play to' / 'Cast to Device' function (see steps 3 – 5). The additional tracks will be added to the playlist in the current 'Play to' / 'Cast to Device' window. You may also delete or change the order of tracks within the 'Play to' / 'Cast to Device' window.
- When you wish to exit 'Local Music' mode, simply either switch off your audio system or select a different operating mode.

Don't forget that in order to reselect the 'Local Music' mode and to be able to use 'Play to' / 'Cast to Device' from Windows you must first ensure that your audio system has an active connection to your network (see steps 1 and 2 above).

Note: Some Windows security software can prevent correct operation of the 'Play to' / 'Cast to Device' function. Such software may have updates or configuration options which will permit 'Play to' / 'Cast to Device' to operate correctly - please consult your anti-virus software supplier. The 'Play to' / 'Cast to Device' function in Windows 7, 8, 8.1 and 10 has been tested successfully with the Stream 67 audio system when using Microsoft's own security software without problems.

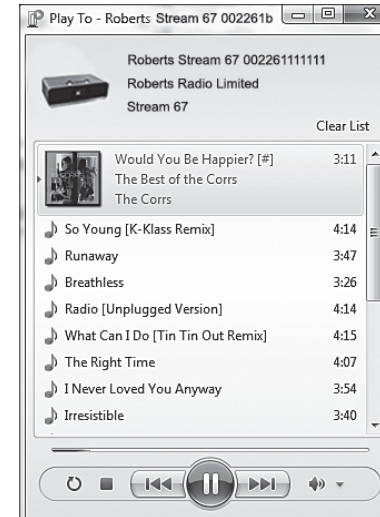

Spotify Connect

What is Spotify?

Spotify is all the music you'll ever need. Millions of songs available instantly. Just search for the music you love, or let Spotify play you something great. Spotify works on your phone, tablet, computer and home speakers. So you'll always have the perfect soundtrack for whatever you're doing. A Spotify account is required to listen on your Roberts Stream 67.

Visit spotify.com

Spotify Connect

A better way to listen at home.

Listen on your speakers or TV, using the Spotify app as a remote. Enjoy the music together.

Listen out loud with Spotify Connect

1. Connect your Roberts Stream 67 to your wifi network.
2. Open up the Spotify app on your phone, tablet or laptop using the same wifi network.
3. Play a song and select Devices Available.
4. Select your Roberts Stream 67 and start listening.

Visit spotify.com/connect to learn more.

Main Features

Instant switching.

From your headphones to any room in the house.

Play together.

Control the music from any mobile, tablet or computer using the Spotify app.

Nonstop tunes.

Make calls, watch videos, go out of range.

The music keeps flowing.

Bring the party.

Readymade playlists for every mood and moment.

Connect to better sound.

Higher sample rates make the most of your music.



Controlling Spotify on your audio system

The music can be controlled using the controls on your audio system as well as by any Spotify enabled device.

1. Press the **Pause** button to pause playback of the current track.
2. Press the **Play** button, playback will resume from the point where it was paused.
3. Press the **Next** button to start playback of the next track in the current Spotify playlist.
4. Press the **Previous** button to start playback of the previous track in the current Spotify playlist.
5. Set the **Volume** control to the required volume level. The volume may also be controlled from within the current Spotify app.
6. Press the **Info** button to step through the available display options.

Using the Mode button to select Spotify

If you have previously connected using the Spotify Connect app you may select Spotify using the mode button on your audio system.

1. Press the **Mode** button to select the Spotify mode.

Please note if the power is removed you will need to re-connect Spotify with your audio system using the app once again.

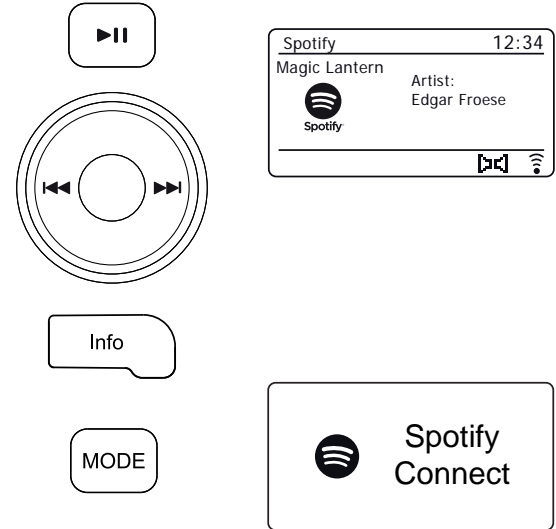

Friendly name - Spotify Connect

Your audio system is identified within the Spotify app using its Friendly Name. By default, your audio system's name will be shown as "Stream 67" followed by a 12 digit alphanumeric code which is the network MAC address that is unique to your audio system.

If you would like to change this name to something more personalised you may follow the [instructions on page 83](#) of this instruction book.

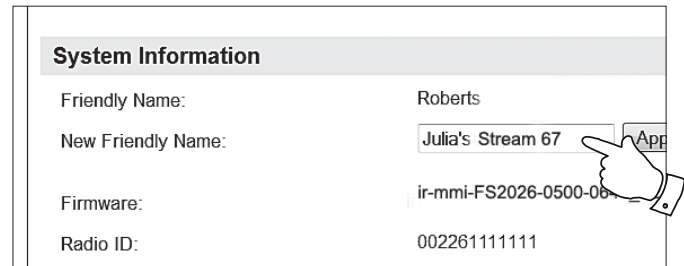

DAB Radio

1. Carefully extend the telescopic aerial. Press **On/Standby** to switch on the audio system. If the audio system has been used before the last used mode will be selected.
2. Press **Mode** as needed to select the DAB Radio mode.
3. If this is the first time that the DAB mode is used a scan of the Band III DAB channels will be carried out. The display will show 'Scanning'. During the scanning process, as new stations are detected the station counter will increase and the stations will be added to the list which is stored in the audio system. The bar graph indicates the progress of the scan. When scanning is completed the audio system will list the stations found (in numeric-alpha order 0....9...A...Z), unless it has previously tuned to a DAB station.
4. Press **Menu Up** or **Down** to scroll through the list of available DAB radio stations. Press **Select** to select the highlighted station. The display may show 'Connecting...' while the radio re-tunes. Use the **Volume** controls to set the sound level as needed.
5. If the station list is still empty after the scan the display will show 'Service not available'. If no stations are found it may be necessary to relocate your audio system to a position giving better reception.

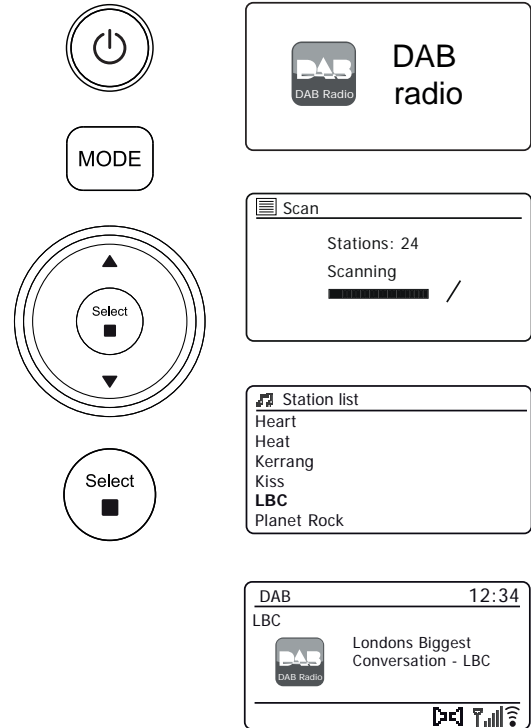

Selecting a DAB radio station

1. When playing a DAB radio station, press **Menu Up** or **Down** to access the radio station list and to scroll through the available stations.
2. Press **Select**. The display may show 'Connecting...' while the radio re-tunes.

Note: A question-mark in front of the station name indicates that the station has not recently been detected by the audio system.

[The use of the radio station presets is described on page 25.](#)

Secondary services

Some radio stations may have one or more additional broadcasts associated with them. If these are available, they will appear immediately after the main station as you press **Menu Up** or **Down**. To tune to the selected service, press **Select**.



Finding new DAB radio stations

Should you wish to use your audio system for DAB reception in a new location, or if no stations were detected during the initial scan, you can follow this procedure to allow your audio system to find out which DAB radio stations are available.

1. Press **Mode** as needed to select the DAB Radio mode.
2. Press **Menu**.
3. Choose 'Scan'.
4. Press **Select**. The display will show 'Scanning' and your audio system will perform a scan of the Band III DAB frequencies. As new stations are found the station counter will increase and stations will be added to the list. The bar graph indicates the progress of the scan.
5. Alternatively, press the **Auto Tune** button on the remote control to initiate a scan of the DAB band III frequencies. The Auto Tune button may not operate in all display modes. In this case use the menu option above.

Manual Tuning

Manual tuning allows you to tune your audio system to a particular DAB frequency in Band III. Any new stations found will be added to the station list. This function can also be used to assist the positioning of the telescopic aerial or the audio system to optimise reception for a specific channel or frequency.

1. When in DAB mode, press **Menu**. Choose 'Manual tune'.
2. Choose the required DAB channel. Press **Select**.

When the radio has tuned, the display shows the channel number and frequency, and the name of the DAB multiplex found (if any). A bar graph shows the signal strength and is useful if you need to reposition the audio system or its aerial. The minimum signal marker 'I' which separates the left and right parts of the signal graph shows the minimum signal level required for satisfactory reception. Any new radio stations found on the tuned DAB multiplex will be added to the list stored in the audio system.

3. Press **Menu** or **Back** to choose a different frequency.
4. Press **Menu** or **Back** a second time to access the main DAB menu then select 'Station list' to return to normal tuning.



Menu

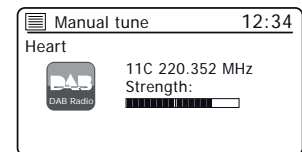
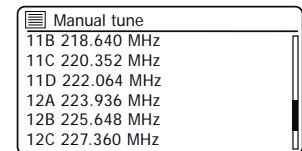
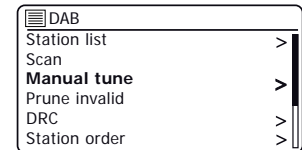
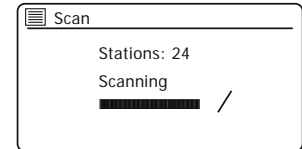
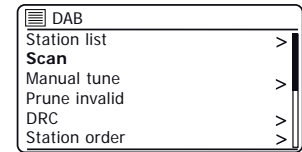
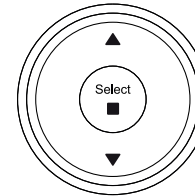

Dynamic Range Control settings

The DRC facility can make quieter sounds easier to hear when your audio system is used in a noisy environment.

1. When in DAB mode, press **Menu**.
2. Choose 'DRC' and then choose the required DRC setting (default is Off).
DRC Off - DRC is switched off, Broadcast DRC will be ignored. DRC Low - DRC level is set to 1/2 that sent by broadcaster. DRC High - DRC is set as sent by broadcaster.
3. Press **Select** to confirm the setting. **Note:** Not all DAB broadcasts use the DRC function. If the broadcast does not provide DRC information, then the DRC setting in the audio system will have no effect.

Station order setup

Your audio system has 3 station order settings from which you can choose. The station order settings are, alphanumeric, ensemble and valid. **Note:** The default station order is alphanumeric.

1. When in DAB mode, press **Menu**.
2. Choose 'Station order' and then choose 'Alphanumeric' (list alphabetically), 'Ensemble' (organised by DAB multiplex) or 'Valid' (shows only those stations for which a signal can be found).

Prune stations

If you move to a different part of the country, some of the stations which were listed may no longer be available. Also, from time to time, some DAB services may stop broadcasting, or may change location or frequency. Stations which cannot be found, or which have not been received for a very long time are shown in the station list with a question mark. The Prune stations function will delete the marked DAB stations from your station list.

1. When in DAB mode, press **Menu**.
2. Choose 'Prune Invalid' and then choose 'YES' to cause the invalid station names to be removed from the station list. If you do not wish to prune stations choose 'NO'.

Note: If you have moved your audio system to a different part of the country you should also carry out a search for new stations ([please see the section 'Finding new stations' on page 46](#)).

Menu

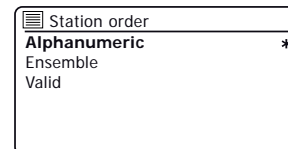
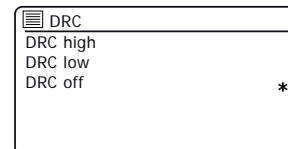
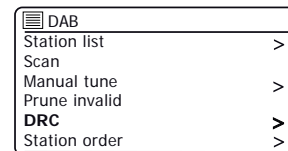
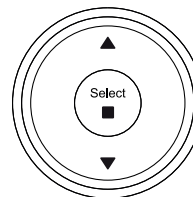

Menu

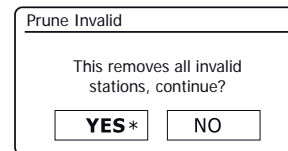
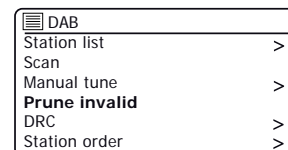
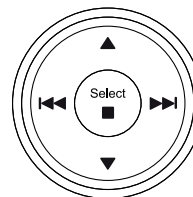

FM Radio

Operating your audio system in FM mode

1. Carefully extend the telescopic aerial and press **On/Standby** to switch on the audio system.
2. Press **Mode** as needed to select the FM Radio mode.
3. **Apply a long press** on the **Menu Up** button (on the remote control) or rotate the **Tuning** control clockwise (on the unit) and then press the control. The displayed frequency will increase. Your audio system will scan up the FM band from the currently displayed frequency and will stop scanning when it finds a station of sufficient strength.
4. The display will show the frequency of the signal which has been found. If RDS information is available, after a few seconds the display will show the radio station name.

If you only hear hiss or interference, **apply a long press** on **Menu Up** to scan further. Your radio may have found a spurious interference signal.

5. To scan down in frequency, **apply a long press** on the **Menu Down** button (on the remote control) or rotate the **Tuning** control anti-clockwise (on the unit) and then press the control. Your audio system will scan down the FM band from the currently displayed frequency and will stop scanning when it finds a signal of sufficient strength.
6. Alternatively, the **Auto Tune** button (on the remote control) can also be used.
7. When the end of the waveband is reached your radio will recommence tuning from the opposite end of the waveband. Adjust the volume as needed.

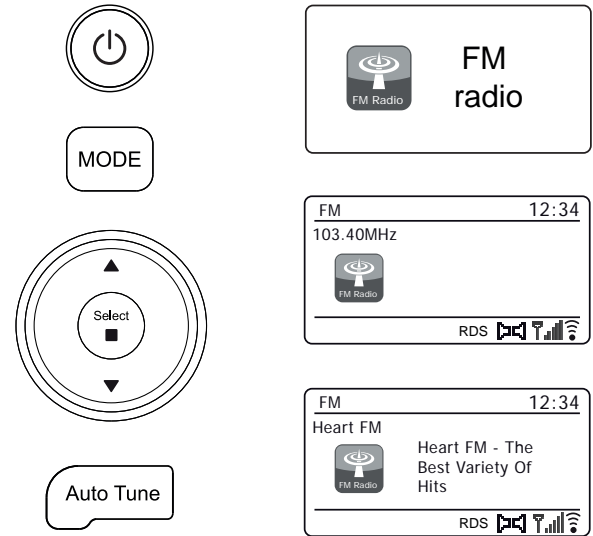

Manual tuning

1. Press **Menu Up** and **Down** to tune to a station. The frequency will change in steps of 50kHz. Adjust the volume.



Scan sensitivity setting - FM

Your audio system will normally scan for FM broadcasts which are strong enough to give good reception. However, you may wish the Auto-scan function to also be able to find weaker signals, possibly from more distant radio transmitters. Your audio system includes a local / distant option for the Auto-scan function.

1. When in FM mode, press **Menu**.
2. Choose 'Scan setting'.
3. To set your audio system so that only the stations with the strongest signals are found during scanning choose 'YES'. (Normally this will restrict scanning to local transmissions).
4. Alternatively, to set your audio system so that all available stations are found during scanning (local and distant transmissions) choose 'NO'.

Note: The initial setting (out of the box, or after a System Reset) causes the audio system to ignore weaker (or more distant) signals.

Stereo / Mono switching - FM

Your audio system will play stereo FM broadcasts in stereo provided that the received signal is of adequate strength. However, as a stereo signal becomes weaker the audio signal will become poorer.

It may be preferable to force the audio system to play the station in mono in order to reduce the level of background hiss.

1. Ensure your radio is in FM mode and tune to the required FM station.
2. To change the audio setting, press **Menu**.
3. Choose 'Audio setting'. The current audio setting is indicated with an asterisk. To switch to mono in order to reduce the hiss from a weak FM signal choose 'YES' or choose 'NO' to return to the normal automatic 'stereo or mono' setting.

Menu

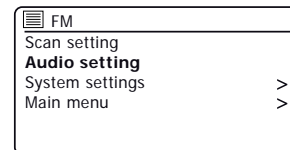
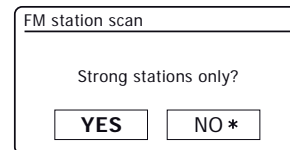
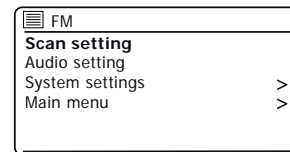
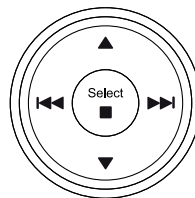

Menu

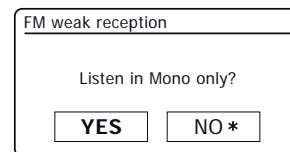
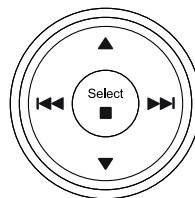

The Bluetooth mode on your audio system allows you to play audio, play sound from video files and stream music from Bluetooth capable devices such as your mobile phone, computer, tablet etc. through your audio system's loudspeakers.

- When a Bluetooth enabled device such as your Stream 67 audio system is in a 'discoverable' state other Bluetooth devices can detect, pair with or connect to it.
- 'Bluetooth pairing' occurs when two Bluetooth enabled devices agree to establish a connection and communicate with each other.

Connecting Bluetooth devices

1. Ensure that the Bluetooth capability on your phone, tablet or PC is enabled. You may need to refer to the user documentation for your device, since the method will vary with each device.
2. Ensure your audio system is switched on.
3. Press the **Mode** button on your audio system until the Bluetooth mode is selected. Your audio system will show that it is 'discoverable' and the **Bluetooth indicator** will flash blue. If the indicator is blue and not flashing, then the audio system is already connected to another device. To cause the audio system to become 'discoverable', press the **Bluetooth Pair** button (on the remote) or **apply a long press** on the **Bluetooth Pair** button (on the unit). Your Stream 67 will become discoverable by other devices.
4. Using the Bluetooth settings of your phone, tablet or PC direct it to search for 'discoverable' devices. After a few seconds, you should see a device named 'Stream 67'. Just occasionally it may take longer for the audio system to be found by your device.
5. Select 'Stream 67' to cause your phone, tablet or PC to pair with your audio system and to establish a connection.
6. Once the connection is established the Bluetooth indicator will remain steady.

You can now begin playing music from your smart-phone, tablet, etc.

Some Bluetooth devices may require a 'Passkey' (an authentication key) in order to establish a link between devices. A passkey is similar to a password, although you only need to use the passkey once to establish a link. If your device asks for a passkey to be able to pair with your audio system then enter a code of 0000 (four zeroes).

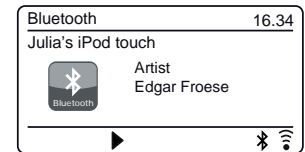
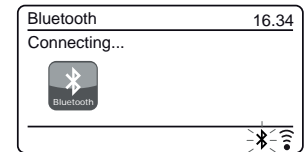

Playing audio files in Bluetooth mode

When you have successfully connected your audio system with your chosen Bluetooth device you can start to play your music using the controls on the device.

1. Once playing has started adjust the volume to the required setting using the **Volume** control on your audio system or the connected Bluetooth device.
2. The volume of your audio system in Bluetooth mode is affected by the volume settings on the audio system and also on the connected Bluetooth device.

If you adjust the volume control on the audio system but you find that the volume from the audio system is not sufficient, it may be that the volume setting of the connected device needs to be increased.

3. The audio player in your phone, tablet or PC may be able to respond to the **Play**, **Pause**, **Next** track, **Previous** track buttons on the audio system.

Note: Not all player applications or devices may respond to all of these buttons.

Volume +

Volume -

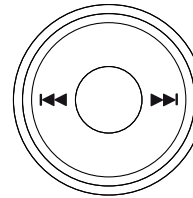

Connecting and reconnecting a Bluetooth device

You can only have one Bluetooth device connected to the audio system at any one time although it may be paired with several devices. Once you have a Bluetooth enabled device connected to your audio system it cannot be interrupted by another Bluetooth device unless you choose to break the connection.

1. To connect to a different device, press the **Bluetooth Pair** button (on the remote) or **apply a long press** on the **Bluetooth Pair** button (on the unit). The **Bluetooth indicator** flashes blue. Your Stream 67 audio system will become 'discoverable' by other devices.
2. You can now pair the audio system with a new device using its Bluetooth settings the audio system will be listed as 'Stream 67'. When the new Bluetooth connection has been established the **Bluetooth indicator** will remain steady. You may then play music from the new device through the audio system.
3. If you no longer want your Bluetooth device to be paired with your audio system you will need to delete the 'Stream 67' pairing on the device. Please refer to the device's Bluetooth documentation.

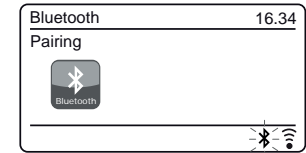

Bluetooth information

Bluetooth connectivity performance may vary depending on the connected Bluetooth devices. Please refer to the Bluetooth capabilities of your device before connecting to your audio system. All features may not be supported on some paired Bluetooth devices.

A Bluetooth connection can provide a link for audio up to a distance of approximately ten metres. When pairing two Bluetooth enabled devices, for convenience, we recommend they should be no more than 2 to 3 metres apart. The presence of other functioning Bluetooth devices during connection may lead to operational difficulties.

Bluetooth is a short-range radio communication system and generally Bluetooth devices can communicate with each other clearly within a regular sized room or office. The reliability of a Bluetooth connection between different rooms will greatly depend upon the construction of the building.

Bluetooth communication range may be substantially reduced if the signal passes through a solid object. Human bodies, brick and concrete walls, heavy furniture or bookcases will all reduce the operational range of your Bluetooth devices to a greater or lesser extent. Glass, dry-wall or wood paneled walls and office partitions may have a less severe but noticeable effect. Metal pipes, foil-lined plasterboard, metal window frames and domestic wiring can also have an effect. You should position your Bluetooth devices closer to each other if you observe communication difficulties.

WiFi networks and cordless phones generally use similar radio frequencies to Bluetooth and may interfere with one another. If any interference is noticed, then try relocating the audio system or one of the other devices.

The Bluetooth capabilities of your audio system enable it to receive audio from many Bluetooth capable devices including mobile phones, personal computers and tablets. Only one Bluetooth device can be connected to your audio system at a time. It supports the following Bluetooth profiles and functionality.

- Your audio system supports A2DP (Advanced Audio Distribution Profile) which is a stereo audio connection that streams stereo music from PCs, mobile phones etc. SBC and AAC audio codecs are supported.
- Your audio system supports AVRCP (Audio Video Remote Control Profile) which allows your audio system to control music playback from the connected device.

Note: Some mobile phones may temporarily disconnect from your audio system when you make or receive calls. Some devices may temporarily mute their Bluetooth audio streaming when they receive text messages, emails or for other reasons unrelated to audio streaming. Such behaviour is a function of the connected device and does not indicate a fault with your audio system.

Note: If the unit is in the Bluetooth mode and it is not playing from a Bluetooth device for more than 15 minutes it will automatically switch to the standby mode. To use the audio system again, simply press On/Standby to switch it on.



Compact discs

Use only Digital Audio CDs which have the  symbol.

Use only full size CDs (12cm diameter) with the audio system. Mini CDs (8cm diameter) are not compatible with the player and may jam the CD mechanism.

Transparent or partly transparent CDs cannot be played since they may not be detected when inserted. Unusually thin (Eco) CDs cannot be played. Some copy-protected CDs may not be playable.

Never write on a CD or attach any sticker to the CD. Always hold the CD at the edge and store it in its box after use with the label facing up.

To remove dust and dirt, breathe on the CD and wipe it with a soft, lint free cloth in a straight line from the centre towards the edge.

Cleaning agents may damage the CD.

Do not expose the CD to rain, moisture, sand or to excessive heat. (e.g. from heating equipment or in motor cars parked in the sun).

CD-R/CD-RW discs

Your Stream 67 can playback CD-DA format audio CD-R/CD-RW discs that have been finalised* upon completion of recording.

*Finalising enables a CD-R/CD-RW disc to playback on audio players such as your audio system. A disc which has not been finalised may have information added to it using a computer but may not always be playable. You may have to specifically enable the finalising step with some CD writing software.

Your audio system may fail to play some CD-R/CD-RW discs due to poor recording and wide variation in quality of the CD-R/CD-RW disc.

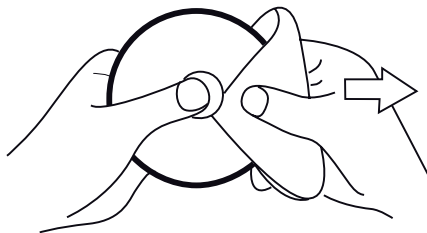

MP3/WMA CD Mode

The Stream 67 audio system is able to play CD-R and CD-RW discs containing MP3 and WMA files. It is assumed in this section that a file is equivalent to a CD track.

An MP3 / WMA CD may not contain more than 9999 files and not more than 999 folders. Audio files should be created with an audio sample rate of 44.1kHz (this is normal for files created from CD audio content). Audio files data rates up to 320 kilobits per second are supported. WMA Lossless, WMA Voice, WMA 10 Professional and files which have DRM protection are not supported.

When burning CD-R and CD-RW discs with audio files, various problems may arise which could lead to problems with playback. Typically such problems are caused by poor CD writing or audio encoding software, or by the hardware settings of the PC's CD writer, or by the CD being used. Should such problems arise, contact the customer services of your CD writer or software manufacturer or look in their product documentation for relevant information. When you are making audio CDs, take care to observe all legal requirements and ensure that the copyright of third parties is not infringed.



Inserting a CD

Ensure the CD player is empty before inserting a disc. If you cannot insert a disc, **apply a long press** on the **CD Eject** button (on the top panel of the unit) to remove the CD currently in the player.

1. Press the **On / Standby** button to switch on your audio system.
2. To select the CD mode press the **Mode** button until 'CD' shows on the display or insert an audio CD.
3. To eject a CD **apply a long press** on the **CD Eject** button. To reload a CD that has just been ejected, **apply a long press** on the **Eject** button.
4. Insert a disc with printed side facing up into the CD slot. The disc will be loaded automatically. The unit will check the CD type and load its track list. The display will show 'Loading' and then 'Reading' as the information is read.
5. If you load a disc containing MP3 or WMA files your audio system will enter the MP3 / WMA mode.

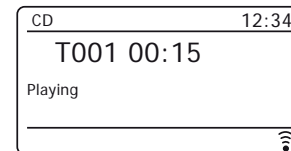
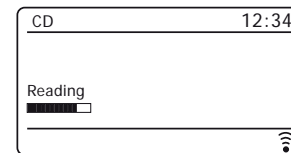

Playing a CD

1. Press the **Play / Pause** button to start playing the disc. Audio CD - the display will show the first track number. MP3/WMA CD - the display will show the first folder and file numbers.
2. Adjust the **Volume** to the required setting.
3. To pause playing press the **Play / Pause** button. To resume play press the **Play / Pause** button again.
4. To stop playback, press the **Stop** button.
5. If you put the unit into standby mode then the next time the unit is switched on it will return to the previously played track.

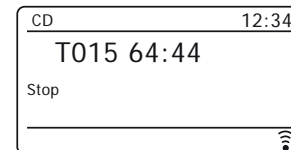
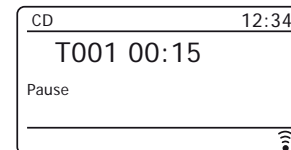
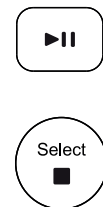

Ejecting a CD

- To take out the CD, **apply a long press** on the **CD Eject** button (on the top panel of the unit). The display will show 'Eject'. In order to protect the disc if it is not removed, the unit will reload the CD after 10 seconds and then enter standby mode.

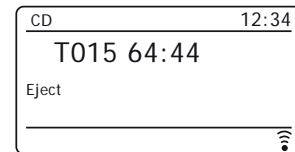
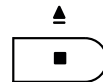

Selecting a track

- While the CD is playing, press either the **Next** or **Previous** buttons to change to the desired track. The updated track number is shown in the display.
- You can also skip tracks when the player is paused. Skip to the desired track using the **Next** or **Previous** buttons, release the button when the desired track is displayed.
- Press the **Play / Pause** button to play the selected track.

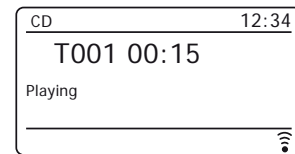
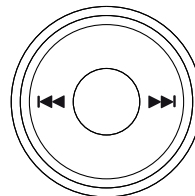

Selecting a track

- For track numbers 1-10 simply press the corresponding digit button on the remote control. For track numbers ten and above press the required digits using the 10/0 button to enter the digit zero.
- If the track number exceeds the number of tracks on the CD, then the last track on the CD will be played.

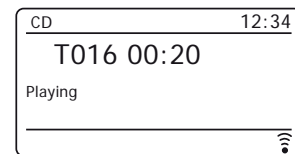
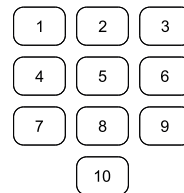

File numbers up to 512 may be entered. The numbers of files in folders are added together. So, for example, if the first two folders each contain 10 files, then entering 15 will play the fifth file in the second folder.



To skip to another folder

1. With the MP3 / WMA CD in play mode, press and release either the **Folder Up** or **Folder Down** buttons. The first file of the next or previous folder will be played.

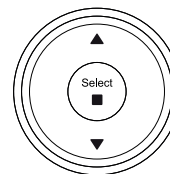

Search function

1. While the CD is playing, **apply a long press** on the **Next** or **Previous** buttons. Release the button when the desired part of the track is reached.

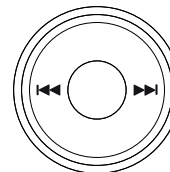

Repeat a single track

1. While the CD is playing, press the **Repeat** button until the repeat single track symbol () appears in the display. The current track will be repeated.



Repeat a folder

1. While the CD is playing, press the **Repeat** button until the repeat folder symbol () appears in the display. The current folder will be repeated.



Repeat all tracks

1. While the CD is playing, press the **Repeat** button until the repeat all tracks symbol () appears in the display. All of the tracks on the CD will be played repeatedly.



To cancel the repeat function, press the **Repeat** button as needed.



Shuffle tracks

1. While the CD is playing, press the **Shuffle** button until the shuffle symbol (🔀) appears in the display. To cancel the shuffle function, press the **Shuffle** button as needed.



Browse CD files

Alternatively when playing MP3 and WMA CD files there is a browse option in the Menu.

1. Press **Menu** to access the CD browse option.
2. Press **Menu Up** or **Down** to select the desired folder or file.
3. Press **Select** to begin playing from the highlighted file.

Menu

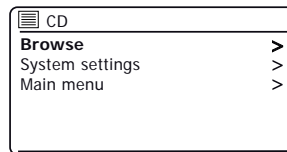
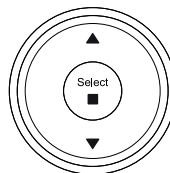

Display modes

Your audio system has a range of display options when in MP3/WMA CD mode.

Note that not all information may be available for all files. Press the **Info** button to cycle through the different options.

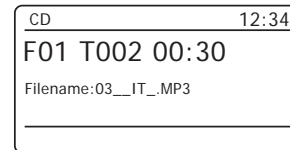

Clock and Alarms

Automatically updating the clock

Your audio system will normally update the clock automatically when connected to the internet. If you enter a time setting manually, the audio system will calculate a local time offset which is then stored in memory. Whenever it synchronises the clock using the internet, including after a power failure, your audio system will then set the clock automatically using this information.

Alternatively you may specify that the time is not automatically updated. In this case the clock must always be set manually after a power interruption.

1. With your audio system switched on, press **Menu**.
2. Choose 'System settings', 'Time/Date', 'Auto update' and then choose an update option from 'Update from DAB', 'Update from FM', 'Update from Network' or 'No update' as required.

Setting the clock format

The clock display used in Standby mode and on the playing mode screens can be set to 12 or 24 hour format. The selected format is then also used when setting the alarms.

1. With your audio system switched on, press **Menu**.
2. Choose 'System settings', 'Time/Date', 'Set format' and then select either 12 or 24 hour. The current clock display format is marked with an asterisk.

If the 12 hour clock format is chosen, the audio system will then use the 12 hour clock for the setting of alarms, and will display a 12 hour clock with an AM or PM indicator when in standby mode.

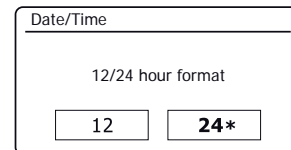
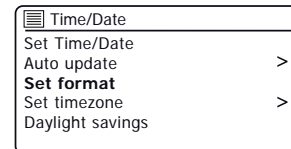
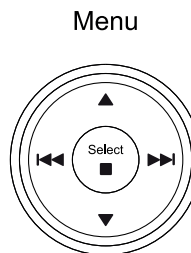
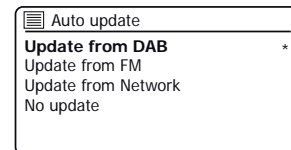
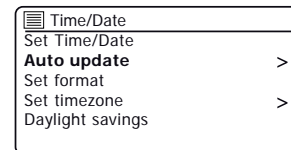
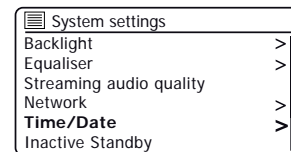
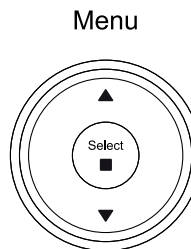

Manually setting the clock

After a connection to the Internet has been established, your audio system will normally set its clock automatically to the local time zone that was specified during setup ([see page 11](#)).

Should you need to set the time manually, change the time zone, or manually switch from winter to summer time (from GMT to BST in the UK, also commonly known outside the UK as daylight savings time), then please follow this procedure.

1. With your audio system switched on, press **Menu**.
2. Choose 'System settings'.
3. To change the current time or date setting choose 'Time/Date', 'Set Time/Date', and then set the correct day, month, year, hour and minute digits.
To change the time zone setting go to step 5.
To change from winter to summer time go to step 6.
4. The display will then return to the previous menu.
5. Select 'Set timezone' and choose the time zone which is applicable to your location.
6. Select 'Daylight savings'. The asterisk shows the current setting.
In the UK, ON is equivalent to British Summer Time, OFF is equivalent to Greenwich Mean Time.
7. Choose 'ON' or 'OFF' as required. Press **Menu** to exit.

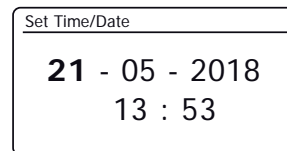
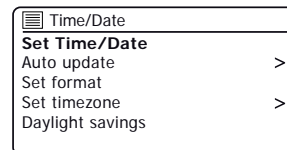
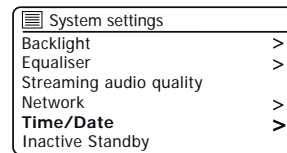
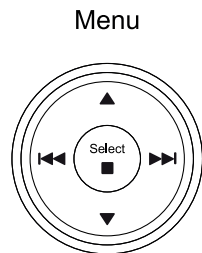

Setting the alarm clock

Your audio system has two separate alarms which can be set to wake you to either the radio, CD or a buzzer alarm. In the event of a power interruption your audio system has built in memory that will retain your alarm settings. Ensure that the time is set correctly before setting the alarms.

Alarms may be set while the audio system is in standby mode or switched on.

1. To change the states of the alarms while the audio system is in *Standby* press the **Alarm** button. The display will cycle through No Alarm, Alarm 1 enabled, Alarm 2 enabled or Alarms 1 and 2 enabled.
2. To change the alarm settings while the audio system is in Standby, **apply a long press** on the **Alarm** button. This will cause the Alarms menu to be displayed. Then skip to step 5 below.
3. To change the alarm settings while the audio system is switched on, either press and release the **Alarm** button and then skip to step 5 below, or alternatively press **Menu**. Choose *'Main menu'*.
4. Choose *'Alarms'* the current alarm settings will be displayed. If no change is required, press the **Menu** button to exit.
5. Choose alarm (1 or 2).
6. Choose *'Time'* and then choose the alarm hour and then the alarm minute. If the audio system has been set to use a 12 hour clock format, there will also be an option here for setting AM or PM for the alarm time.
7. The display will then return to the alarm setting menu.
8. Choose *'Enable'*. The display will show the Frequency options for the alarm. The alarm frequency options are as follows:

'Off' - the alarm will be disabled

'Daily' - the alarm will sound everyday

'Once' - the alarm will sound once

'Weekends' - the alarm will sound only at weekends

'Weekdays' - the alarm will sound on weekdays only

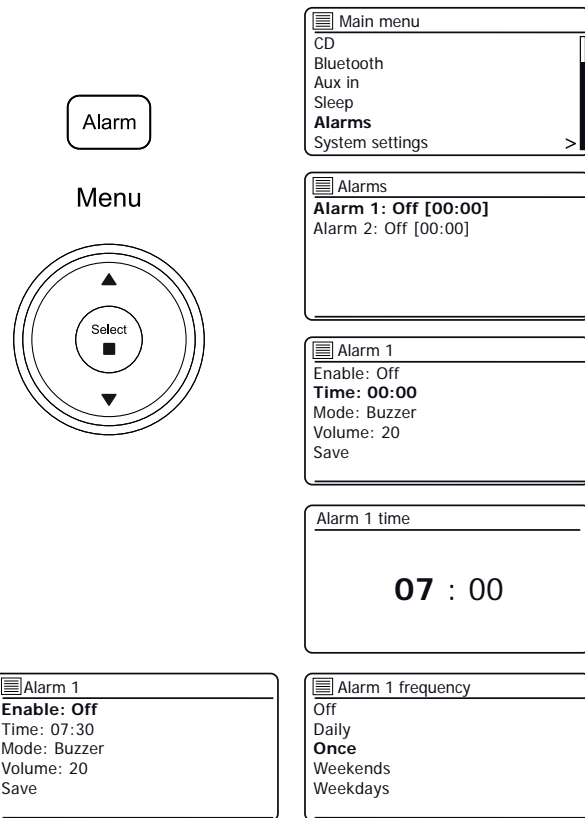

Setting the alarm clock - cont.

9. Choose the alarm frequency option. Choosing Off will disable the alarm.
If you choose to set the alarm to Once you will also need to set the date.
10. The alarm can be set to buzzer, Internet radio, DAB radio, FM radio or CD. For whichever radio mode is selected, the radio alarm may be set to any of the stations which have been stored as presets or to the station most recently listened to.
Choose the 'Mode' option for the alarm either 'Buzzer' or the required radio mode.
11. If setting the alarm to a radio option, choose the 'Preset' option.
Choose from either the radio station 'Last listened' to, or from the presets 1 - 10. Scroll to the chosen option and press Select to confirm the selection.
Note: The alarm may only use a preset which has already been stored.
12. Choose the 'Volume' option. The audio system uses the saved volume setting for each alarm when it sounds. Use the **Menu Up** and **Down** and **Select** buttons to set the required volume setting.
13. In order to store the alarm settings select the 'Save' option. Press **Select**. Your audio system will show 'Alarm Saved' and will then go back to the list of alarms with the new alarm setting shown in the display.

If you decide not to save the settings, press **Menu** or the **Back** button. The display will show 'Save changes' with a 'YES' or 'NO' option. Choose 'NO'. 'Alarm not saved' will show on the display.

Active alarms are shown using small alarm indicators on the playing displays and on the clock display when in Standby. **Note:** If you make a mistake, use the **Menu** button to go back to the previous screen.

When the alarm sounds

The buzzer, CD or radio alarm will sound at the selected times for up to 60 minutes unless cancelled. The volume used for the alarm will be as specified during the alarm setting procedure. If the audio system cannot connect to the specified DAB radio station, the buzzer alarm will be used instead. If setting the alarm to CD ensure a CD is inserted.

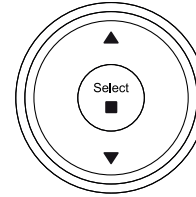

Menu

Back

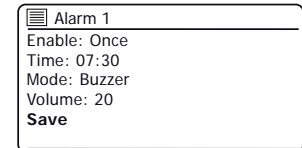
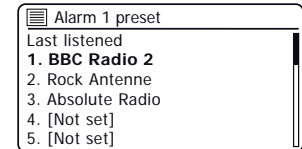
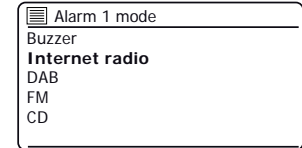
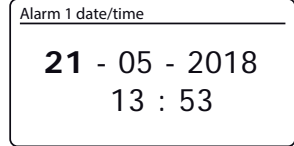
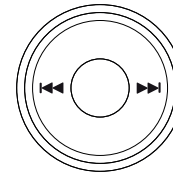

When the alarm sounds cont.

1. During an alarm, the alarm icon will flash on the display. The audio system will automatically revert to standby mode after 60 minutes.
2. To cancel an alarm, press **On/Standby** to return to Standby mode.

Note: If the audio system is switched on because of an alarm you can control basic functions such as volume. You cannot perform operations which involve the **Select** control since this also acts as the Snooze (see below).

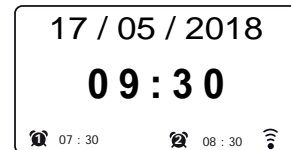

Snooze timer

1. The buzzer, CD or radio alarm can be silenced for 5 minutes by pressing the **Select/Snooze** control. Should you wish for a longer snooze duration this can be extended. Pressing **Select** again while the audio system is snoozed will set the available snooze time to 5, 10, 15 or 30 minutes.
2. While the snooze timer is active the remaining snooze time is shown next to the flashing alarm icon on the clock display.
3. In order to cancel the Snooze timer while the alarm is suspended, press **On/Standby**. The display will briefly show an 'Alarm Off' message.



Disabling alarms

1. To disable an alarm while the audio system is in standby mode press and release the **Alarm** button to cycle through the [alarm on-off options \(see page 61, step 1\)](#).
2. To disable an alarm while the audio system is playing enter the Alarms menu ([see page 61, steps 3 and 4](#)) and select alarm (1 or 2).
3. Choose 'Enable' and choose the 'Off' option.
4. Choose the 'Save' option and press **Select** to save the new setting. The chosen alarm will now be disabled.

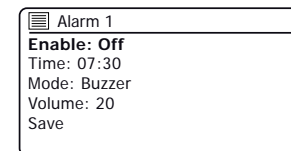
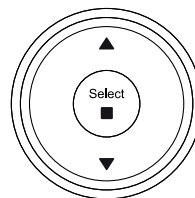

Sleep timer

Your audio system can be set to turn off after a preset time has elapsed. The sleep timer can be adjusted between 15 and 120 minutes.

1. Press **On/Standby** to switch on the audio system.
2. Press the **Sleep** button (on the remote control) or **apply a long press** on the sleep button (on the unit) to enter the sleep options.
3. Repeatedly, press the **Sleep** button (on the remote control) or rotate the **Tuning** control (on the unit) to choose the required sleep time setting. The sleep timer can be set to between 15 and 120 minutes, or to Off. Press **Select** to confirm the setting.
4. To set the sleep time using the menu, press **Menu** and then choose 'Main menu', 'Sleep' and the required sleep time. Press **Select** to confirm the setting.
5. Your audio system will switch into Standby mode after the preset time has elapsed.
6. An active sleep timer is shown using a small timer indicator at the bottom of the playing displays. This indicator also shows the sleep time remaining before the audio system switches itself into Standby mode.
7. To cancel the sleep time before the preset time has elapsed and to turn off the audio system, press **On/Standby** to turn the audio system off manually.
8. To cancel the sleep timer and leave the audio system playing, go back into the sleep timer settings (steps 2 to 3 above) and select the Off option in step 3.



Menu

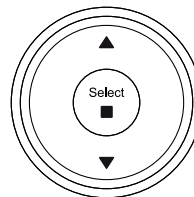

Clock and Alarms

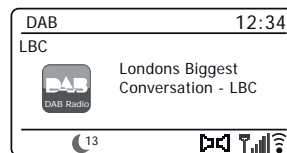
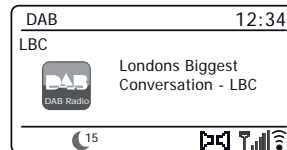
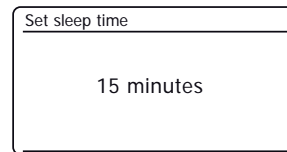

Multi-room - the basics

Your Stream 67 audio system may be used with other products as part of a multi-room system.

Products may be combined into a synchronised group allowing several units to play the same content around your home.

Multiple groups may be configured for different areas of the home or for different users.

Different products may use the same or different operating modes, but audio will not be synchronised between groups, only between products in the same group.

You may control a single product, a group of products, or even multiple groups using the UNDOK app or your audio system's controls.

Each group that you configure may contain up to five compatible products. Typically as many as 16 products may operate together on a single network. The maximum number of products that will work together reliably is dependent upon the reliability and capability of the network.

Compatible products from Roberts also allow content from other sources to be shared with all of the products in a group. These include CD, DAB and FM radio.

The UNDOK app allows you to:

- Create a group
- Rename a group
- Edit a group - add or remove one or more products
- Delete a group
- Control a group - choose operating mode and browse for content
- Adjust volume for an entire group or for individual products within a group
- Control products which have not been assigned to any group



Control via the UNDOK app



Creating and editing a multi-room group with UNDOK

You can use the UNDOK app to combine your Stream 67 audio system into a group with the other multi-room products.

Note: You may add up to five connected audio products into any one group.

1. Access your list of connected audio products within UNDOK.
2. A list of audio products connected to your network will be shown.
3. Select the edit group icon.
4. UNDOK will show the group setup screen and a list of the products available for grouping.
5. Select the audio products that you wish to add into your group (a maximum of four additional products). You may add or remove products as needed.
6. You may rename your group, for example *'Family Room'* or *'Down Stairs'* etc.
7. Confirm your selection.
8. You may choose to delete a group. The products that were previously in the group will then be listed as individual products.

Multi-room & UNDOK

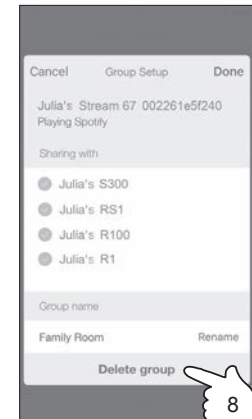
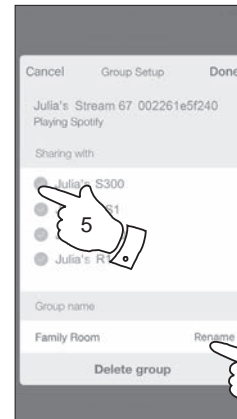
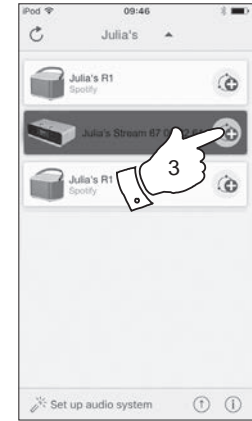
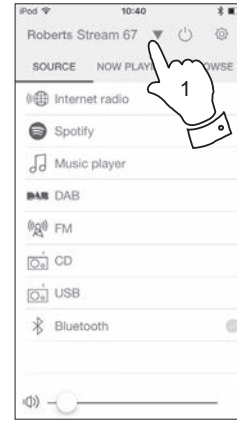

Playing audio to a group

The process of choosing the audio source and content for a group of products is almost the same as for a single product.

1. Select the desired group (or individual product if not in a group).
2. Select the desired source. If more than one product offers the same source type, e.g. Bluetooth then each will be shown in the source menu.
3. Select 'Now Playing' or 'Browse' as needed to access content for the selected source.

Volume control using UNDOK

UNDOK allows you to control the volume of a group of products and the volume of individual products within the group.

1. Use the multiple products icon to access the individual volume controls.
2. You may also mute either the group, or products within the group using the speaker icon.
3. The equaliser for products in a group can also be accessed from the group's volume control.

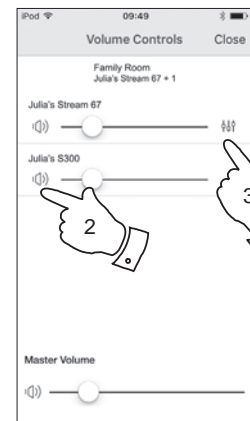
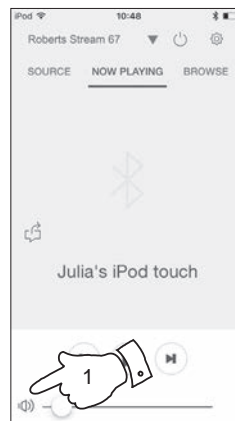
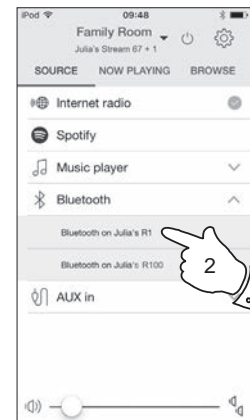

Display and Controls in a multi-room configuration

1. When your audio system is used in a multi-room group and it is acting as the source, providing content to other products in the group, it is said to be acting as the group Master (or Server – please also see next page).

In this situation, the audio system's display will show the current operating mode and related information, just as if the audio system was operating alone and not as part of a multi-room group.

2. The buttons of the product will operate in all modes exactly as they do when the product is used on its own. The On / Standby button will control the On / Standby state of all products within the same group.
3. When your audio system is used in a multi-room group and it is receiving content from one of the other products in the group, it is said to be acting as a Client (please also see next page).

In this situation, the audio system's display will show that the audio system is active but is playing as part of the group. It will not be able to display additional information about the content being played in this mode.

4. While playing as a group client, the volume control buttons on the audio system will operate normally but will not affect others in the group.

Some of the media controls (Play / Pause / Previous track / Next track) will be available in some modes (Music player, for example) and will affect playing for all products within the group.

The On / Standby button may be used to put all of the devices in the group into Standby, or to switch them back on, as needed.

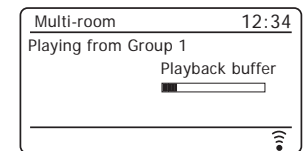
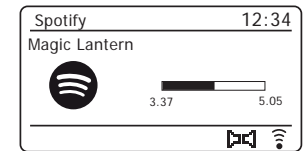
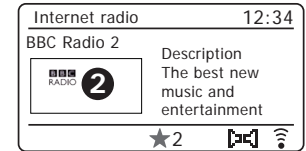

Using your audio system's controls to configure multi-room

In addition to using the UNDOK app you may also use your audio system's controls to configure it as part of a group of multi-room products.

View the audio system's multi-room details

To view the multi-room details for your Stream 67 follow the below procedure.

1. Access the menu for the current mode, press **Menu**.
2. Press **Menu Up** or **Down** until 'System settings' is highlighted on the display.
3. Press **Select** to enter the settings menu.
4. Press **Menu Up** or **Down** until 'Multi-room' is highlighted on the display. Press **Select**.
5. Press **Menu Up** or **Down** until 'View details' is highlighted on the display. Press **Select**. Your audio system's multi-room details will be shown on the display.
 - Ungrouped - The product is not part of a group.
 - Server - The product sends audio content to other group members.
 - Client - The product receives audio from another product in the group.
6. Press the **Back** button to exit the menu.

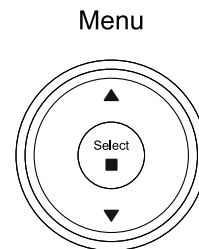
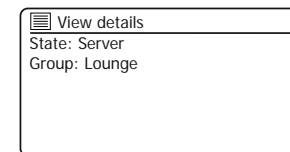
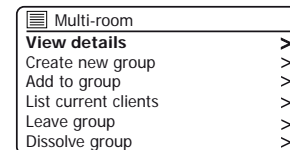
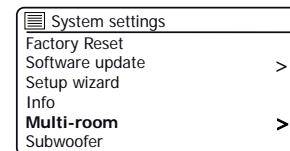
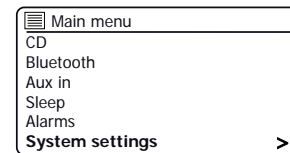

Back



Create a new multi-room group

You can create a new multi-room group using your audio system.

1. Access the menu for the current mode, press **Menu**.
2. Press **Menu Up** or **Down** until 'System settings' is highlighted on the display. Press **Select** to enter the settings menu.
3. Press **Menu Up** or **Down** until 'Multi-room' is highlighted on the display. Press **Select**.
4. Press **Menu Up** or **Down** until 'Create new group' is highlighted on the display. Press **Select**.
5. To enter the group name, characters are selected and entered using the **Menu Up** or **Down**, **Left** or **Right** and **Select** buttons. The highlight scrolls through the available characters as well as the three controls on the right. The character currently highlighted will be entered when you press the **Select** button. Select the '[OK]' symbol when you have entered the text. You can quickly access the three symbols on the right by pressing the **Info** button and then use the **Menu Up** or **Down** and **Select** buttons as needed. The next screen will prompt you to add other connected multi-room products to the current group.
6. If you wish to add a product from the list to the new group, highlight the product using the **Menu Up** or **Down** buttons and press the **Select** button to confirm. The screen will show 'Added'. Products already added to the group are marked with an asterisk.
7. If you do not wish to add another product to the current group press the **Back** button to exit.

Menu

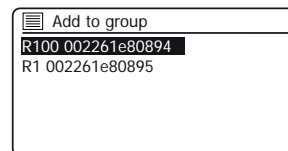
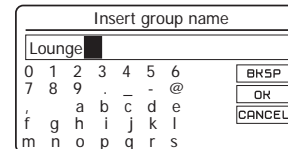
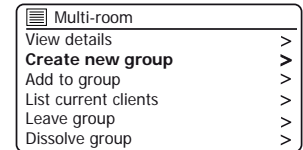
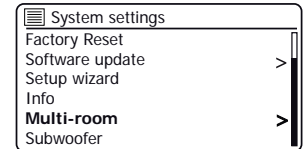
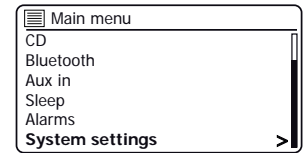
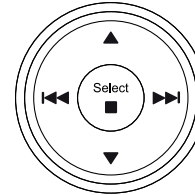

Add products to the current group

You can add other connected multi-room products to the current group using your Stream 67 audio system.

1. Access the menu for the current mode, press **Menu**.
2. Press **Menu Up** or **Down** until 'System settings' is highlighted on the display. Press **Select**.
3. Press **Select** to enter the settings menu.
4. Press **Menu Up** or **Down** until 'Multi-room' is highlighted on the display. Press **Select**.
5. Press **Menu Up** or **Down** until 'Add to group' is highlighted on the display. Press **Select**.
6. If you wish to add a product from the list to the current group, highlight the product using the **Menu Up** or **Down** buttons and press the **Select** button to confirm. The screen will show 'Added'. Products already added to the group are marked with an asterisk. If the adding process displays 'Failed' it is usually because the Stream 67 is not yet controlling a group ([see Creating new multi-room group page 70](#)).
7. If you do not wish to add another product to the current group press the **Back** button to exit.

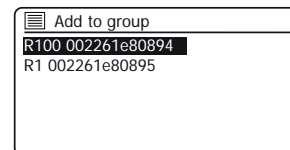
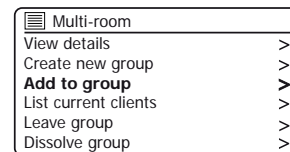
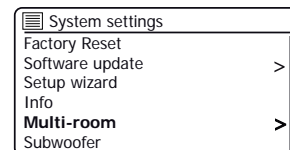
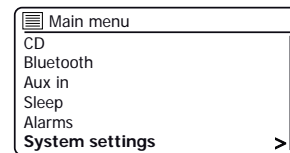
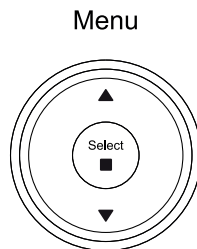

Back



Remove products from a current group

You may remove audio products from the current group using your audio system.

1. Access the menu for the current mode, press **Menu**.
2. Press **Menu Up** or **Down** until 'System settings' is highlighted on the display. Press **Select**.
3. Press **Select** to enter the settings menu.
4. Press **Menu Up** or **Down** until 'Multi-room' is highlighted on the display. Press **Select**.
5. Press the **Menu Up** or **Down** buttons until 'List current clients' is highlighted on the display. Press **Select**. A list of current connected audio products will show on the display.
6. If you wish to remove a product from the current group, highlight the product using the **Menu Up** or **Down** buttons and press the **Select** button to confirm. The screen will show 'Removed'.
7. If you do not wish to remove the product from the current group press the **Back** button to exit.

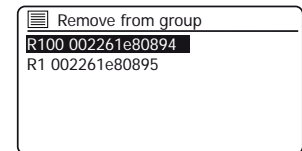
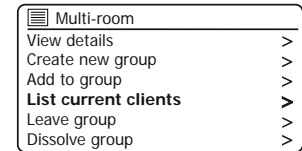
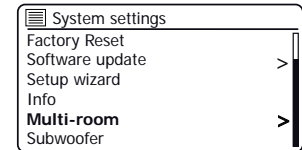
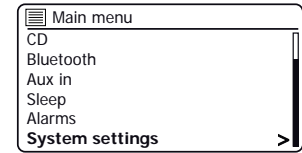
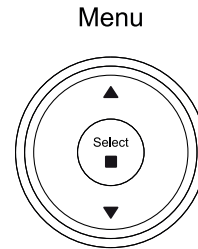

Back



Leave a group

Your Stream 67 audio system can be removed from a current group.

1. Access the menu for the current mode, press **Menu**.
2. Press **Menu Up** or **Down** until 'System settings' is highlighted on the display.
3. Press **Select** to enter the settings menu.
4. Press **Menu Up** or **Down** until 'Multi-room' is highlighted on the display. Press **Select**.
5. Press **Menu Up** or **Down** until 'Leave group' is highlighted on the display. Press **Select**.
6. Your Stream 67 will be removed from the current group.

If your Stream 67 was previously sending audio to other products in the group that will cease. The other products will remain in the group and must then be 'operated' separately.

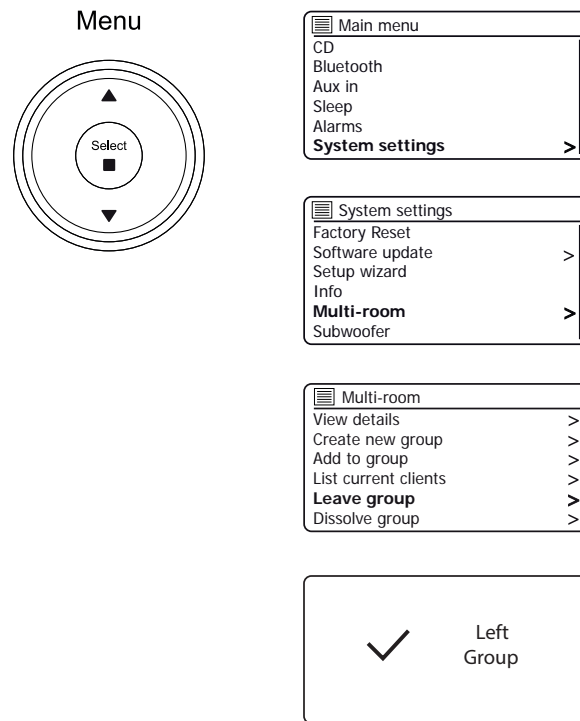

Dissolve a group

You can dissolve a current group.

1. Access the menu for the current mode, press **Menu**.
2. Press **Menu Up** or **Down** until 'System settings' is highlighted on the display. Press **Select**.
3. Press **Select** to enter the settings menu.
4. Press **Menu Up** or **Down** until 'Multi-room' is highlighted on the display. Press **Select**.
5. Press **Menu Up** or **Down** until 'Dissolve group' is highlighted on the display. Press **Select**.
6. The current group will be dissolved.
Each of the products that were in the group can now be operated individually.

Menu

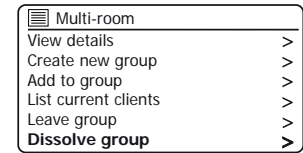
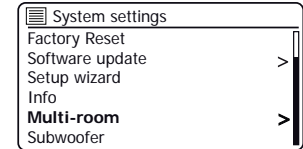
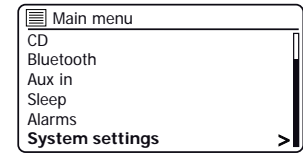
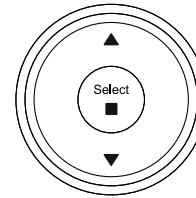

Alarms and Multi-room

If your audio system is configured as part of a multi-room group, then the audio system will remove itself from that group when the audio system switches itself on as a result of an alarm having been set. This is so that an alarm sounding on one audio system will not cause all of the other products in the group to be activated at the same time.

If you wish to use your audio system as part of a multi-room group after using the alarm function, you will need to add the audio system back into the group manually. [This is most easily performed using the UNDOK app as described on page 66.](#)



UNDOK Settings

Equaliser function

The sound on your audio system can be adjusted to suit your personal taste for the material that you are listening to. The Stream 67 has a range of equaliser modes. Alternatively, you may set the bass, mid-range and treble levels to your own preferences.

1. Select the 'Settings' screen and then select 'Equaliser' in UNDOK.
2. Choose the desired equaliser setting or select the 'My EQ' option to adjust the bass, mid-range and treble setting.

Sleep timer

Your audio system can be set to turn off after a preset time has elapsed. The sleep setting can be adjusted as follows.

1. Set the sleep timer using the UNDOK app.
2. Your audio system will switch off after the preset sleep timer has elapsed.

Friendly name

Your audio system is identified within the UNDOK app using its Friendly Name. By default, your audio system's name will be shown as "Roberts Stream 67" followed by a 12 digit alphanumeric code which is the network MAC address that is unique to your audio system. Use the audio system's settings in UNDOK to change its friendly name.

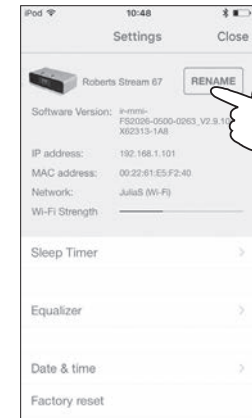
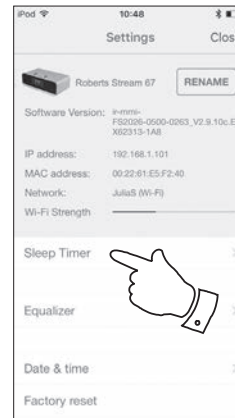
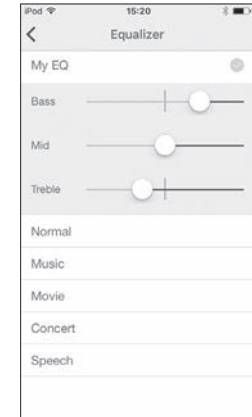
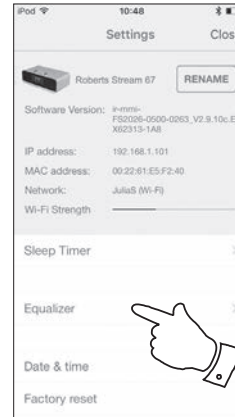

Equaliser function

The sound on your audio system can be adjusted to suit your personal taste for the material that you are listening to. The Stream 67 has a range of equaliser options. Alternatively you may set the bass, mid-range and treble levels to your own preferences which can be accessed from the *My EQ* menu item.

1. With your audio system switched on, press **EQ** on the remote control.
2. Alternatively, press **Menu** and then choose 'System settings', 'Equaliser' and then cycle through and highlight the various option. Press **Select** to confirm your selection. 'Normal', 'Music', 'Movie', 'Concert', 'Speech', 'My EQ'. The currently selected option is marked with an asterisk.

Setting up your My EQ profile

If you find the preset equaliser functions not to your liking, you may set up a custom bass, mid, treble and width setting as follows:

1. Follow steps above in order to enter the Equaliser menu.
2. Choose 'My EQ profile setup' then 'Bass, Mid, Treble or Width'.
3. Choose the desired level. The sound will change as you adjust the setting. Press **Select** when you are happy with the setting.
4. Press **Menu as needed** and the display will prompt you to save the changes. If you wish to save the changes choose 'YES'. If you do not wish to save the changes choose 'NO'. Press **Select**.
5. To use the 'My EQ' profile choose 'My EQ'.

To quickly cancel the effect of the 'My EQ' profile choose 'Normal'.

The settings will be remembered for the next time that you wish to use the 'My EQ' setting.

Note: When listening on headphones only the Bass and Treble settings are used. The Mid and Width setting will have no effect.

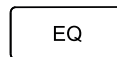

Menu

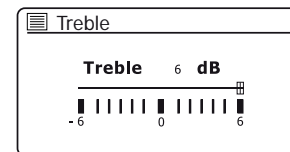
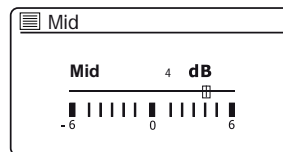
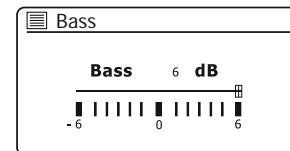
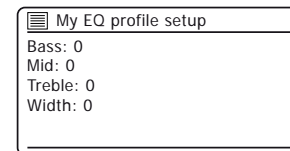
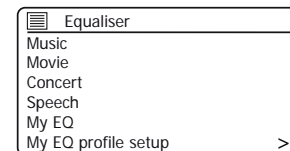
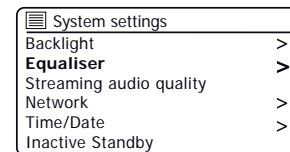
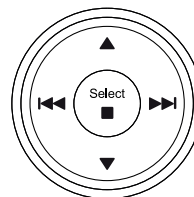
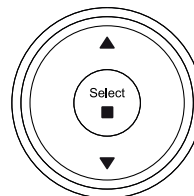

Subwoofer control

In addition to the Equaliser functions described on page 76, the audio system has an additional control for the subwoofer function. This controls the level of deep bass from the audio system's loudspeakers.

If your audio system is located in the corner of a room (especially on the diagonal) then you may need to reduce the subwoofer volume setting on the audio system. This is because the reflections from the walls around the corner will tend to enhance the bass response of the system. Conversely, in a large open area, you may wish to increase the subwoofer volume setting on the audio system.

1. The subwoofer volume control on the remote control adjusts levels of the internal subwoofer function.
2. Alternatively, the subwoofer level setting in the system settings menu can be used to adjust the subwoofer level. **Note:** When listening on headphones the subwoofer control has no effect.

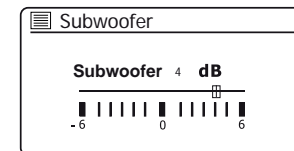
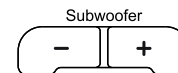

Mute function

Pressing the Mute button will mute the output from the loudspeakers.

1. Press the **Mute** button (on the remote control) to mute the sound output.
2. Press the **Mute** button again or one of the volume buttons to un-mute the sound output.

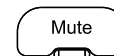

Aerial removal

The fitted telescopic aerial is suitable for most applications. The telescopic aerial may be removed to allow connection to an external aerial using a coaxial cable. First remove the two small screws holding the antenna connector cover in place (use a small cross-head screw driver). Then using a spanner (11 mm), remove the telescopic aerial by rotating in an anti-clockwise direction when viewed from the rear of the product.

This will expose an F-type connector to which an external aerial may be connected.



Brightness control

The brightness of the display can be adjusted for when the audio system is in standby and for when it is in use. If you use the unit in the bedroom, you may prefer a lower standby brightness level than the standard setting.

There are 4 Standby brightness levels and 3 levels for when the audio system is in use. To change the current brightness setting please follow these steps.

1. Press the **Dimmer** button (on the remote) or **apply a long press** on the Dimmer button (on the unit) to select the desired brightness level.
2. Alternatively, press **Menu** and then choose 'Main menu', 'System settings' then 'Backlight' to access the display brightness setting.
3. To adjust the brightness when the audio system is switched on select 'On level'. To adjust the brightness when the audio system is in standby select 'Standby level'. Press **Select**. The current setting will be marked with an asterisk.
4. Choose either the 'High', 'Medium' or 'Low' setting. If setting the standby brightness level there is also an option to set the brightness to 'Very low'. Press **Select** to set the level. If the audio system is playing, then the chosen brightness will be applied immediately. If the audio system is in standby, then the chosen brightness will be applied after a 10 second delay.

When the audio system is in Standby mode, pressing a button or turning a rotary control will cause the audio system to switch to the high brightness level for a few seconds. This is so that even if the standby brightness level is set low, it is still possible to see the time when needed.

Display and Audio

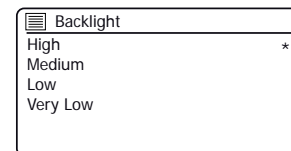
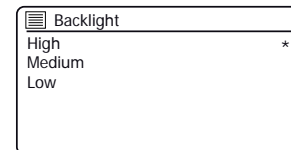
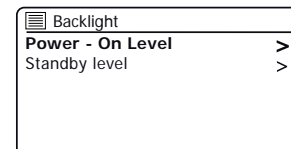
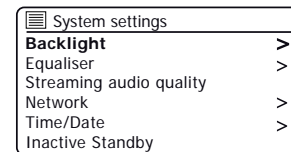

Dimmer

Back

Dim

Menu

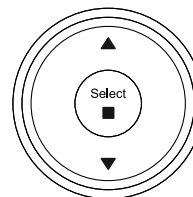

Headphone socket

A 3.5mm **Headphone Socket** located on the rear of your audio system is provided for use with headphones. Inserting a plug automatically mutes the internal loudspeakers. Please be aware that the sensitivity of headphones can vary widely. We therefore recommend setting volume to a low level before connecting headphones to the audio system. **IMPORTANT:** Excessive sound pressure from earphones and headphones can cause hearing loss.



To prevent possible hearing damage, do not listen at high volume levels for long periods.

Auxiliary input socket

A 3.5mm **Auxiliary Input** socket located on the rear of your audio system is provided for connecting the audio signal from an external audio source such as an MP3 or CD player.

1. Connect a stereo lead from the headphone output of your MP3 or CD player to the Aux In socket located on the rear of the audio system. Typically this lead will have a 3.5mm stereo plug at both ends.
2. Switch on your audio system and press the **Mode** button until 'AUX in' mode is shown on the display.
3. Press 'play' on the connected audio device. If you are using its headphone output for the connection, set its volume control to a level of somewhere between two-thirds and maximum (the objective is to get a strong audio signal but without too much distortion). Then adjust the volume on the audio system as required.

Note, if using an iPod as the sound source, you may need to set its output to maximum to get an adequate audio signal level.

4. After use, disconnect your player in order to listen to your audio system conventionally.

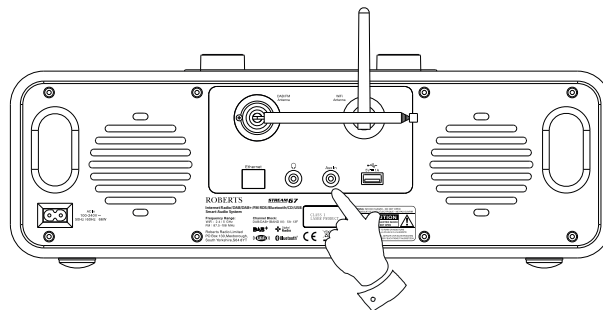
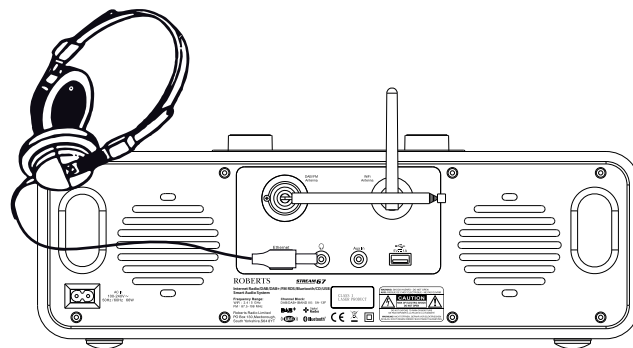

MODE



Inactive Standby feature

The Inactive Standby timer allows your sound system to save power by automatically going to Standby if no controls are used for a period of time. By default this period is set to 8 hours but you may change it if you wish.

1. With your audio system switched on, Press **Menu**.
2. Choose 'Main menu' and then 'System settings'.
3. Choose 'Inactive Standby' and then choose from 2, 4, 6, 8 hours or Off.
4. Press **Select** to confirm setting.
5. Your audio system will go into standby after the selected time has expired. Setting Inactive Standby to Off will disable this feature.

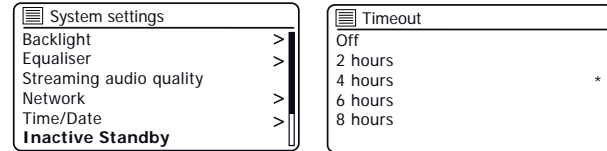

USB socket for smartphone or tablet charging

Your audio system has a USB socket which can be used for charging a smartphone, tablet or other similar devices.

Charge time may vary and in some cases may take longer to charge than when using the manufacturers charging unit supplied with the device.

1. Ensure your audio system is plugged in.
2. Connect your device to the USB charging socket on the rear of your audio system.
3. Your device will begin to charge. Once your device has charged remove the USB lead.

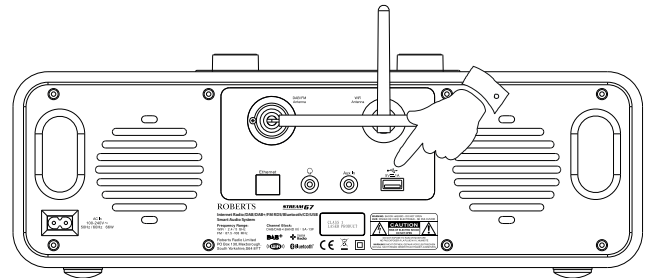

Information

Factory reset

If you wish to completely reset your audio system to its initial state this may be performed by following this procedure. By performing a factory reset, all user entered settings will be erased.

1. With your audio system switched on, Press **Menu**.
2. Choose 'Main menu', 'System settings', 'Factory reset' and then 'YES' to proceed.
If you do not wish to carry out a system reset, highlight 'NO' and then press **Select**. The display will revert to the previous menu.
3. With 'YES' highlighted, press **Select**. A full reset will be performed and the audio system will restart as if first plugged in. The DAB stations list together with any preset stations will be erased and your wireless network connection details will be lost. All configuration settings will be restored to their defaults, the clock and alarms will be reset.

Menu

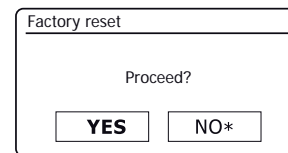
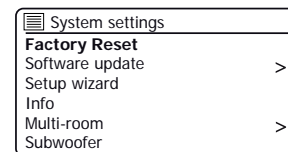
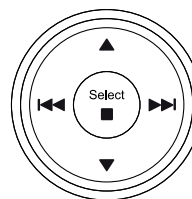

Electro-magnetic compatibility advice

In the event of a malfunction due to electrostatic discharge, mains power supply transients or short interruptions, reset the product as above to resume normal operation. If you are not able to perform the reset operation as above, removal and reconnection of the power supply may be required.

If the product is used in an environment with any ESD Immunity / Radiated Immunity / Conducted Immunity disturbance, the product may malfunction. It will automatically recover to normal when the ESD Immunity / Radiated Immunity / Conducted Immunity disturbance is stopped.

Product markings

	USB output 5V / 1A
	<p>Recycling</p> <p>This product bears the selective sorting symbol for Waste Electrical and Electronic Equipment (WEEE). This means that this product must be handled pursuant to European directive 2012/19/EU in order to be recycled or dismantled to minimize its impact on the environment.</p> <p>The user has the choice to give the product to a competent recycling organization or to the retailer when buying a new electrical or electronic equipment.</p>



Software update

From time to time, new software features for your product may be developed. Your product has therefore been designed to allow its internal software to be updated using your Internet connection. You should not attempt to update your product unless it is recommended to you by Roberts Customer Services. Updating the software may remove all network settings, radio station presets and alarm settings from your product. It is important that you do not attempt this procedure unless you have a good Internet connection and a reliable mains power supply. If the product connects to your router using a WiFi connection, make sure that this is also reliable before proceeding.

1. The 'Software update' option is accessed via the System Settings menu. When you select 'Software update' the menu will display 'Auto check setting' and 'Check now'. If you want your product to check periodically for new software versions choose 'Auto check settings' and then choose 'YES'. If you do not want your product to check for updates choose 'NO'.
2. To check if there are any software updates available currently, choose 'Check now'. The product will check to see if an update is available. The display will show 'Checking for new versions'. If there are no updates then the display will show 'Software up to date'. If a software update is available your product will then offer the choice of updating the software or not, displaying 'New version available. Update software?'. Select the 'YES' option if you wish to go through the update process. If you choose to update your product it will first download the new software and will then reprogram its internal memory. This may take anything from a few seconds to a few minutes depending on the speed of your internet connection.
3. Once the software update is completed, the product will prompt you to press **Select** to restart. Press **Select** and your product will then restart. You may find that you will need to reconfigure your network connection following an update. You may also need to re-enter all radio station presets, alarm settings, and configuration options.

VERY IMPORTANT: Do not switch off the power to the audio system until the update operation is complete and the audio system has restarted, otherwise the unit may become permanently damaged.

Network profiles

Each time that you connect your product to a WiFi network, the product will store the details of that connection (SSID, security key, DHCP/IP address settings) as a profile. Up to four such profiles are stored in the product so that if the unit is used in multiple locations there is no need to enter the network settings when returning to a location previously visited. The product stores the four most recent profiles in memory identified by their SSID. Normally the product will attempt to connect to one of the stored profiles and only if it is unable to do so will you need to use the [Network Wizard \(see page 16\)](#).

In the event that you visit a location only once you may wish to delete the profile for the network in that location to avoid losing other profiles.

1. Press **Menu**. Choose 'System settings', 'Network' and then 'Network profile'. Press **Select** to see the stored profiles. The profile which is currently in use (if any) is marked with an asterisk.
2. To remove a profile from memory, highlight the profile to be deleted and then press **Select**. The audio system will offer a 'YES' or 'NO' selection. Choose 'YES'. The selected profile will be deleted. Note that it is not possible to delete a profile which is currently in use.

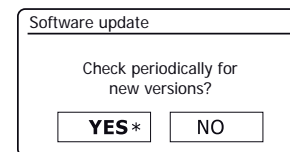
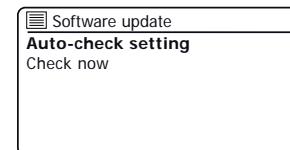
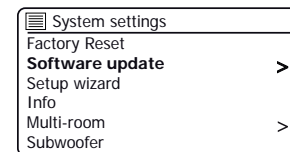

Software version display

The software version display is provided for reference and customer support purposes.

1. Press **Menu**. Choose 'System settings' and then 'Info'. The display will show the software version and radio ID. Press **Menu Up** or **Down** to display further information.
2. Press **Menu** to exit.

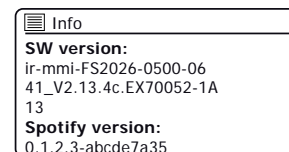
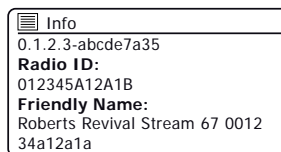
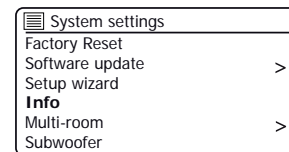
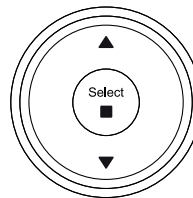

Friendly name

Your audio system uses a Friendly Name so that it is identifiable within remote control software such as the UNDOK app, UPnP server and control software, and the Spotify app. By default, your audio system's Friendly Name will be shown as the "Roberts Stream 67" followed by a 12 digit alphanumeric code which is the network MAC address that is unique to your audio system. If you would like to change this name to something more personalised you may either use the UNDOK app or follow the instructions below.

1. Press **Menu** and choose 'System settings', 'Network' and then 'View settings'. The current network settings will be displayed.
2. Press **Menu Up** or **Down** until the IP address is showing on the display. This is the local IP address used by your audio system on your network. In the example screen to the right the IP address is 192.168.1.27. Make a note of the IP address shown on your audio system's display for the next stage.
3. Ensure that your computer is on the same network as the audio system. On your computer enter the IP address noted above into the address bar of your web browser. For example, enter 192.168.1.27 followed by Return. This will allow you to view some of the audio systems settings and will allow you to change the friendly name. Type the new name in the box as shown and then click Apply to save the name. The new Friendly Name will now be visible to network connected devices.

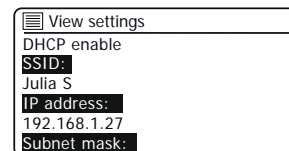

If you experience any trouble with your audio system, then you may find it useful to visit the help section on our web site.

As a first step, the following points should be checked.

Is there power to the audio system?

- Make sure your product is plugged in and connected to the mains - see page 10.
- Ensure your product is switched on.

Is your audio system not receiving audio?

- Check the volume level of your product.
- Check your product is in range and that you have connected your product to your network.
- Ensure the product and the device used for control is connected to the **same** network.
- Ensure that WiFi is enabled on your device. Refer to your device's documentation for details.
- If your product is not visible within UNDOK, first try restarting the UNDOK app on your device. Try reinstalling the UNDOK app and check that you have the latest version installed.
- If the WiFi connection to the product appears unreliable, try relocating the audio system or try an Ethernet connection to verify the functioning of the product.
- Try to eliminate possible interference from other sources e.g. cordless phone, microwave oven etc.

If you have difficulty connecting the audio system to your computer network, some of these steps may help to resolve the problem:

1. Confirm that a WiFi connected PC can access the Internet (i.e. can browse the web) using the same network.
2. Check that a DHCP server is available (normally a router function). Your audio system will by default use DHCP unless you choose to disable it. This may be configured using the menu items '*Main Menu*' -> '*System settings*' -> '*Network*' -> '*Manual settings*'. This will ask first whether you wish to configure a wired or a wireless connection. For either wired or wireless you then need to choose '*DHCP enable*' or '*DHCP disable*'. If you enable DHCP then the audio system will negotiate with your router (or DHCP server) and will be provided with an IP address as well as the other settings needed. If you wish to set the network configuration manually, refer to paragraph 6.
3. Check that your network's firewall is not blocking any outgoing ports. As a minimum, the audio system needs access to UDP and TCP ports 80 and 123. Port 53 may be required for DNS. Some Internet radio services may require additional ports to be open. Windows Media Player 12 will allocate a port number for UPnP media sharing and will configure Microsoft's Windows built-in firewall appropriately. Other firewall software may require configuration for UPnP or to allow particular IP addresses to have trusted access.
4. Check that your access point does not restrict connections to particular MAC addresses (sometimes called MAC address filtering).
You can view the audio system's MAC address using the menu items '*Main Menu*'-> '*System settings*'-> '*Network*'-> '*View settings*'-> '*MAC address*'. The MAC address will typically be of the form
00 : 22 : 61 : xx : xx : xx
5. If you have an encrypted network, check that you have entered the correct encryption key into the product. Remember that text-format WPA keys are case sensitive. If your audio system displays '*Network error*' when attempting to connect to an encrypted network, then please ensure that you enter the correct key for the network. If the problem persists, then you may need to re-check your network configuration.



Troubleshooting cont.

6. If you need to set up your audio system's IP address manually, you will need to know low-level details of your network's configuration. Use the menu items 'Main Menu' -> 'System settings' -> 'Network' -> 'Manual settings' -> 'Wired' or 'Wireless' (as needed) -> 'DHCP disable'.

The audio system will then prompt you in turn for the Ethernet IP address, Ethernet Subnet mask, Ethernet Gateway address, Ethernet Primary DNS, Ethernet Secondary DNS

If you are setting up a wireless connection manually you will also need to enter the SSID, the encryption type, and the encryption key.

See page 17 for full details on how to set up your audio system's network configuration manually.

If your audio system can connect to the network, but is unable to play a particular Internet radio station, it may be due to one these causes:

1. The station is not broadcasting at this time of the day.
2. The station has reached its maximum allowed number of simultaneous connections.
3. The Internet connection between your audio system and the server (often located in a different country) is slow. This could be due to internet congestion, either locally or at a distance.
4. The station may choose to block internet connections to your geographic region (sometimes known as geo-locking).
5. The station is no longer broadcasting. The database of radio stations that your audio system connects to is frequently updated and checked but may not always be completely accurate.
6. The radio station is broadcasting using an audio format which is not playable by your audio system (although the Stream 67 does play the most popular formats used by regular broadcasters).

Try using a PC to listen via the broadcaster's web site or via the radio station database web site at <https://www.wifiradiofrontier.com>. If you can play the station with a PC, it may be that the internet feed or local network connection is poor. However, some broadcasters (such as the BBC) provide different data streams for PC users and Internet radio listeners, so this test is not always conclusive.

If you cannot play the station via your PC this may indicate that the problem is not necessarily due to your audio system, but it could be your network, your internet connection, the broadcaster, or internet congestion.

Music Player / UPnP problems

The use of the Music Player function with UPnP should be straightforward. However, the cleverness of UPnP means that it is often disabled by default by security applications and in routers.

If you are using Windows Media Player as your UPnP server, and if it fails to operate with your audio system, please keep this fact in mind: *A fresh installation of Windows and Windows Media Player when using Microsoft's built-in firewall software will normally work.*

If it does not work, possible reasons may include:

UPnP functions blocked in firewall software

UPnP functions turned off by security software

UPnP functions 'hi-jacked' by other software

UPnP functions blocked in the router

Multi-cast packets blocked in the router

IP address of system blocked in firewall software

Some third-party UPnP servers are much less dependent upon other parts of Windows than WMP 12. If the greater flexibility that these offer is attractive, it may also be found in some cases that they are easier to get working.



Your audio system supports a range of audio codecs which provide compatibility with a wide range of Internet Radio stations. These also allow users to stream music from their computers or to play directly from USB flash memory devices.

Note that for any given audio codec, there are many streaming protocols available, and thus even if an Internet Radio station uses a supported format, this does not guarantee that every such station will work with your audio system. The radio stations database to which your audio system connects is checked for compatibility so that most stations should be playable without problems. Similarly when streaming media from a computer, while a codec may be supported, there can be many subtle variations in formats, tagging schemes and protocols (even within UPnP). In general your audio system will play the supported formats with most common UPnP servers.

The following table summarises the maximum supported bit-rates for the various audio formats that are playable on your audio system. Higher rates may be playable in some cases but performance of the product may be affected.

Codec	Maximum supported data rate
AAC (LC, HE, HE V2)	320 kbits/sec
ALAC ⁽¹⁾	1.5 Mbits/sec
FLAC ⁽²⁾	1.5 Mbits/sec
LPCM ⁽³⁾	1.536 Mbits/sec
MP3	320 kbits/sec
WAV ⁽³⁾	1.536 Mbits/sec
WMA ⁽⁴⁾	320 kbits/sec

All codecs support 2-channel (stereo) coded files only.

All codecs support sample rates up to 48 k samples/sec (includes 32 k and 44.1 k samples/sec).

Files which have Digital Rights Management (DRM) protection applied will not be playable on your audio system.

(1) 16 bit samples are supported in ALAC files.

(2) 16 and 24 bit samples are supported in FLAC files.

(3) The maximum supported bit-rate is for 48 kHz sampling, 2 channels and 16-bits per sample.

(4) WMA Lossless, WMA Voice, WMA 10 Professional, and files which have DRM protection are not supported.

(5) When using your audio system as part of a group of multi-room products, audio files in ALAC and FLAC formats will only play on the group master [\(see page 31\)](#).



Cautions

Do not allow your product to be exposed to water, steam or sand.
Do not leave your product where excessive heat could cause damage.
The name plate is located on the rear the audio system.



- Use only the mains lead provided with the product, or a genuine replacement provided by Roberts Radio. The use of alternative mains leads will invalidate the guarantee.

- The mains lead and audio system shall not be exposed to dripping or splashing and no objects filled with liquids, such as vases, shall be placed on the mains lead or the audio system.
- It is recommended to operate the product such that there is a minimum distance (10cm recommended) to adjacent objects in order to ensure good ventilation.
- The ventilation of the product should not be restricted by covering it with items such as newspapers, tablecloths, curtains etc.
- No naked flame sources such as lighted candles should be placed on the product.
- It is recommended to avoid using or storing the product at extremes of temperature. Avoid leaving the unit in cars, on window sills, in direct sunlight etc.
- The mains lead and audio system must be used in a moderate climate.
- There are no user serviceable parts inside this product.
- Do not attempt to disassemble any part of the product.
- To maintain the compliance with the WiFi RF exposure requirement, place the product at least 20 cm (8 inches) from nearby persons except when operating the controls.



Specifications

Power Requirements

Mains	100 - 240 volts AC, 50-60Hz  only
Remote control batteries	2 x AAA size

Connectivity

Wired Ethernet 10/100M bits/sec via RJ45 connector

WiFi 802.11 b, g, n or a supported with WEP and WPA / WPA2 encryption

Compatible with 2.4 GHz and 5 GHz WiFi bands.

Use restriction: This device is authorised in the following countries for indoor use only when used with 5GHz Wi-Fi (5150 to 5350MHz; channels 36 to 64):

BE	EL	LT	PT	BG	ES	LU
RO	CZ	FR	HU	SI	DK	HR
MT	SK	DE	IT	NL	FI	EE
CY	AT	SE	IE	LV	PL	UK

Frequency Coverage

FM	87.5 - 108MHz
DAB	174.928 - 239.200MHz
Bluetooth	2.402 - 2.480GHz

Headphone socket 3.5mm diameter, stereo

Aux In socket 3.5mm diameter, stereo

Aerial System WiFi WiFi antenna
DAB/FM Telescopic aerial

Bluetooth standards A2DP, AVRCP
Bluetooth codecs supported SBC and AAC

Operating temperature range +5°C to +35°C

Product markings

 This symbol indicates AC voltage.

 This symbol indicates Class II equipment.

Hereby, Roberts Radio, declares that this product is in compliance with the essential requirements and other relevant provisions of Directive 2014/53/EU. The full text of the EU declaration of conformity is available at the following internet address: www.robertsradio.com

The Company reserves the right to amend the specification without notice.



Mains supply

The Stream 67 will operate from a supply of 100-240V ~ 50/60Hz.

DO NOT cut off the mains plug from this equipment. If the plug fitted is not suitable for the power points in your home or the cable is too short to reach a power point, then obtain an appropriate safety approved extension lead or adaptor. If in doubt consult your dealer.

If nonetheless the mains plug is cut off, remove the fuse and dispose of the plug immediately to avoid a possible shock hazard by inadvertent connection to the mains supply.

If this product is not supplied with a mains plug, or one has to be fitted, then follow the instructions given below:

IMPORTANT. DO NOT make any connection to the larger terminal which is marked with the letter E or by the safety earth symbol  or coloured Green or Green-and-yellow.

The wires in the mains lead are coloured in accordance with the following codes :-

BLUE - NEUTRAL

BROWN - LIVE

The wire coloured BLUE must be connected to the terminal marked N or coloured BLACK.

The wire coloured BROWN must be connected to the terminal marked L or coloured RED.

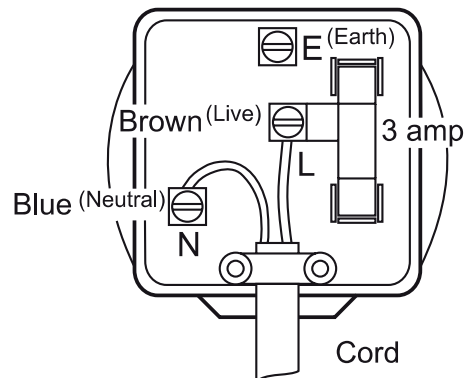

Fuse

When replacing the fuse only a 3A ASTA approved to BS1362 type should be used and be sure to re-fit the fuse cover.

IF IN DOUBT - CONSULT A QUALIFIED ELECTRICIAN.



Software license information

Use of the software in this radio is subject to software licence terms contained in this user manual - by using the radio, you are agreeing to comply with these licence terms:

Thompson Licensing: MP3 audio decoder

MPEG Layer-3 audio coding technology licensed from Fraunhofer IIS and Thomson

Fraunhofer: MPEG-4 HE AAC Audio decoder

MPEG-4 HE-AAC audio coding technology licensed by Fraunhofer IIS:

<http://www.iis.fraunhofer.de/amm/>



Microsoft: Windows Media Audio decoder (WMA)

This product is protected by certain intellectual property rights of Microsoft. Use or distribution of such technology outside of this product is prohibited without a license from Microsoft.

Microsoft: Real Time Streaming Protocol (RTSP)

This product is protected by certain intellectual property rights of Microsoft. Use or distribution of such technology outside of this product is prohibited without a license from Microsoft.

Spotify: Spotify Connect

The Spotify software is subject to third party licenses found here:

<http://www.spotify.com/connect/third-party-licenses>



Guarantee

This product is guaranteed for twenty four months from the date of purchase by the original owner against failure due to faulty workmanship or component breakdown, subject to the procedure stated below. Should any component or part fail during this guarantee period it will be repaired or replaced free of charge.

The guarantee does not cover:

1. Damage resulting from incorrect use.
 2. Consequential damage.
 3. Product with removed or defaced serial numbers.
- N.B. Damaged or broken aerials will not be replaced under guarantee.

Procedure:

Any claim under this guarantee should be made through the dealer from whom the product was purchased. It is likely that your Roberts' dealer will be able to attend to any defect quickly and efficiently, but should it be necessary the dealer will return the product to the company's service department for attention. In the event that it is not possible to return the product to the Roberts dealer from whom it was purchased, please contact Roberts Radio using the contact details on the www.robertsradio.com website.

For product repairs falling outside the guarantee period, please refer to the "Customer care" tab on the www.robertsradio.com website.

These statements do not affect the statutory rights of a consumer.

ROBERTS RADIO LIMITED

PO Box 130
Mexborough
South Yorkshire
S64 8YT

Website: <http://www.robertsradio.com>

© 2019 Roberts Radio Limited



Issue 2

2019-05-16

