

ROBERTS

SOUND 48

DAB / DAB+ / FM stereo clock radio with CD, Bluetooth, USB playback / charging



Please read this manual before use

Contents

Features	2	Selecting a track	15
Menu options	2	CD Repeat function	16
Dimmer	2	CD Intro function	16
Controls (Front)	3	CD random play	16
Controls (rear view)	4	Creating a playlist (program play)	17
Connect to the mains	5	Checking and editing a program	17
Switch on your clock radio	5	USB mode	18
Select a DAB radio station	6	Setting alarms	19
Scan for DAB stations	6	Snooze	20
Display options	7	Cancel alarm	20
Manual tuning - DAB	7	Sleep	20
Dynamic Range Control (DRC) settings - DAB	8	Automatically updating the clock	21
Prune stations - DAB	8	Setting the clock manually	21
Search tuning - FM	9	Language function	21
Manual tuning - FM	9	Software version	21
FM stereo / mono	9	System reset	22
Preset stations	10	Headphone socket	22
Bluetooth mode	11	Auxiliary input (line in) socket	23
Connecting Bluetooth devices	11	USB socket for smartphone or tablet charging	23
Playing audio files in Bluetooth mode	12	Bluetooth information	24
Connecting and reconnecting a Bluetooth device	12	Safety	25
Compact discs	13	Electro-magnetic compatibility advice	25
MP3 / WMA / AAC CD Mode	13	Product markings	25
Inserting a CD	14	Specifications	26
Playing a CD	14	Circuit features	26
CD Bookmark	15	Guarantee	27



Features

- DAB / DAB+ / FM RDS wavebands
- MP3 / WMA / AAC playback for CD
- MP3, AAC, WAV and FLAC playback for USB
- Bluetooth audio streaming from iPhone or Smartphone
- USB charging of smartphone, tablet or similar devices
- 40 station presets
- CD / USB bookmark function
- Four alarms - wake to buzzer, radio, USB or CD
- Adjustable sleep and snooze timers
- Display dimmer
- Display with time or time and date in standby
- Auxiliary input socket for iPod/MP3 playback
- Headphone socket

Menu options

You can access or exit your clock radios menu system by pressing the **Menu** button. Use the **Tuning Up** or **Down** and **Select** buttons to select menu options.

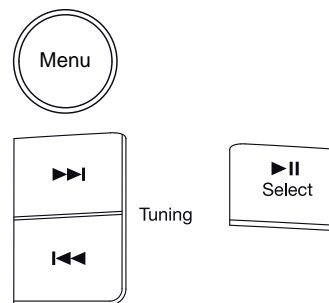

Dimmer

The brightness of the display can be adjusted while the unit is in Standby mode or while playing.

- 1 Press the **Dimmer** button to select the dimmer brightness from High, Mid, Low and an almost off 'night-time' setting.

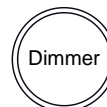

Controls (Front)

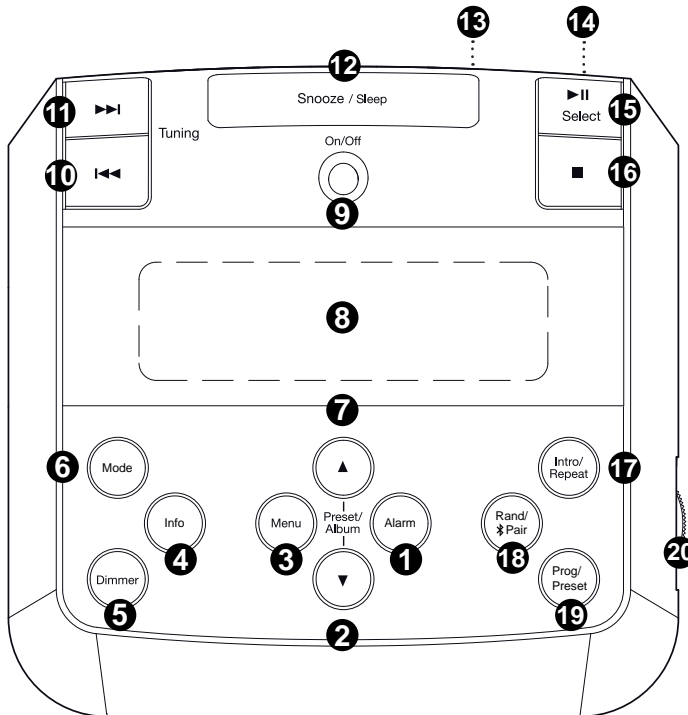

- 1 Alarm button
- 2 Preset / Album Down button
- 3 Menu button
- 4 Info button
- 5 Dimmer button
- 6 Mode button
- 7 Preset / Album Up button
- 8 LCD display
- 9 On / Off button
- 10 Tuning Down / Rewind button
- 11 Tuning Up / Fast-forward button
- 12 Snooze / Sleep button
- 13 CD lid
- 14 CD open / close
- 15 Select / Play / Pause button
- 16 Stop button
- 17 Intro / Repeat button
- 18 Random / Bluetooth Pair button
- 19 Program / Preset button
- 20 Volume control



Controls (rear view)

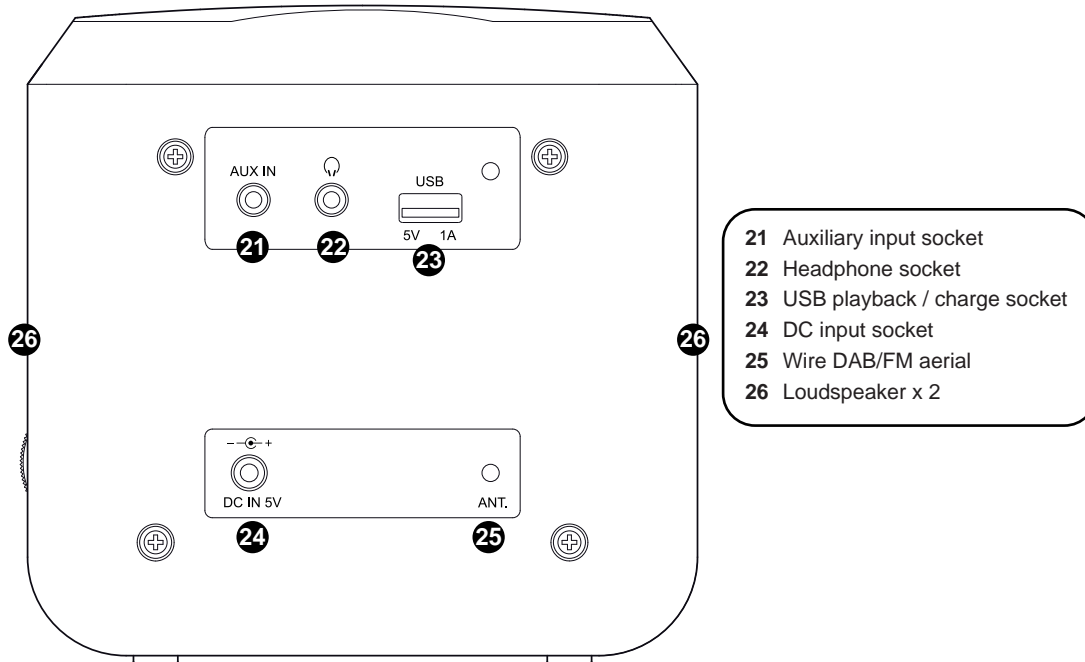

Connect to the mains

- 1 Fully extend the **wire aerial**.
- 2 Plug the cable from the mains adaptor into the **DC input socket**. Plug the mains adaptor into a wall socket and switch on the socket.
- 3 A start up screen will be displayed and a station scan will be performed.
- 4 When a signal has been found, the clock information will appear on the display.

Note: If no signals are found it may be necessary to relocate your clock radio to a position giving better reception and carry out a scan for new stations.

- 5 When your clock radio is in standby press the **Info** button to toggle between time only or time and date.

IMPORTANT: The mains adaptor is used as the means of connecting the product to the mains supply. The mains socket and any multi-way mains block used for the product must remain accessible during normal use. In order to disconnect the product from the mains, the mains adaptor should be removed from the mains socket outlet completely. Use only the mains adaptor provided with the product, or a genuine replacement provided by Roberts Radio. The use of alternative adaptors will invalidate the guarantee.

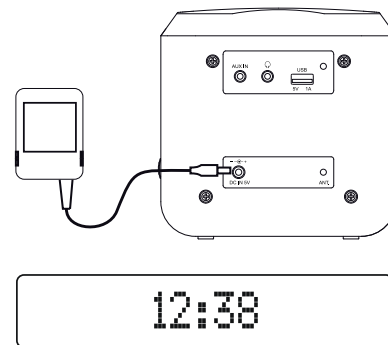

Switch on your clock radio

- 1 Press the **On/Off** button to switch on the clock radio. After each use the clock radio will remember the mode used and then switch on in that mode the next time it is used.
- 2 If this is the first time the radio is used a scan of the Band III DAB channels will be carried out (depending on whether a scan was completed in standby mode).

On/Off



BBC Radio 4
Tuning...

5



Select a DAB radio station

- 1 If needed, press the **Mode** button until the DAB mode is selected.
- 2 Press the **Tuning Up** or **Down** buttons to step through the list of available DAB stations.
- 3 Press the **Select** button to select the station.
- 4 Adjust the **Volume**. Press the **Info** button to cycle through the various display options.

Secondary services - DAB

Some radio stations may have one or more additional broadcasts associated with them. If these are available, they will appear immediately after the main station as you press the **Tuning Up** button. To tune to the selected service press the **Select** button.

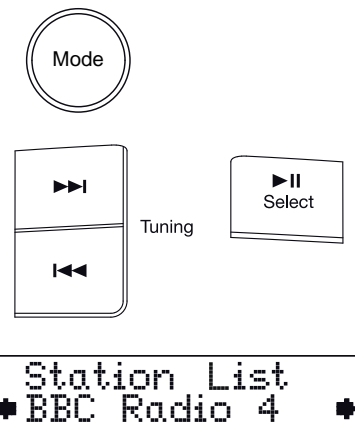

Scan for DAB stations

As time passes new stations may become available or you may have moved to a different part of the country.

- 1 Press and release the **Mode** button until DAB is selected.
- 2 **Give a long press** on the **Tuning Up** or **Down** buttons. Your radio will perform a scan of the Band III DAB channels. As new stations are found, they will be added to the list stored in the radio.
- 3 Alternatively, choose 'Scan' from the DAB menu.

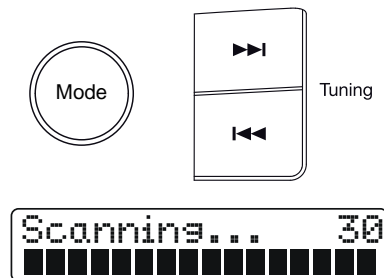

Display options

When in DAB, FM, USB and Bluetooth modes your clock radio has a range of display options.

- 1 Press the **Info** button to cycle through the various options.

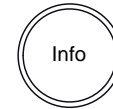

Manual tuning - DAB

Manual tuning allows you to tune your clock radio to a particular DAB frequency in Band III. Any new stations found will be added to the station list. This function can also be used to assist the positioning of the aerial or the clock radio to optimise reception for a specific channel or frequency.

- 1 If needed, press **Mode** until the DAB mode is selected.
- 2 Press **Menu**.
- 3 Press **Tuning Up** or **Down** until the display shows 'Manual Tune'. Press **Select**.
- 4 Press **Tuning Up** or **Down** to select the desired DAB channel.
- 5 Press **Select**. The open block in the signal strength graph shows you the minimum signal strength needed for good DAB reception. The signal blocks will go up and down showing the changing signal strength as you adjust the wire aerial or the clock radio position. Any new radio stations found on the tuned DAB multiplex will be added to the list stored in the radio.
- 6 Press the **Select** button to return to the normal tuning mode.

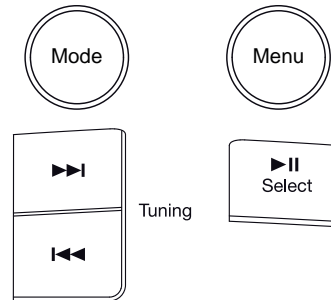

Dynamic Range Control (DRC) settings - DAB

The DRC facility can make quieter sounds easier to hear when your radio is used in a noisy environment. There are 3 DRC settings.

- 1 When in DAB mode, press **Menu**.
- 2 Press **Tuning Up** or **Down** until the display shows 'DRC'. Press **Select**. The current DRC value will be marked with an asterisk.
DRC 0 - DRC is switched off, Broadcast DRC will be ignored. DRC 1/2 - DRC level is set to half sent by broadcaster or DRC 1 - DRC level is set as sent by broadcaster.
- 3 Press **Tuning Up** or **Down** to select the required DRC setting.
- 4 Press **Select** to confirm setting.

Not all DAB broadcasts use the DRC function. If the broadcast does not provide DRC information, then the DRC setting in the clock radio will have no effect.

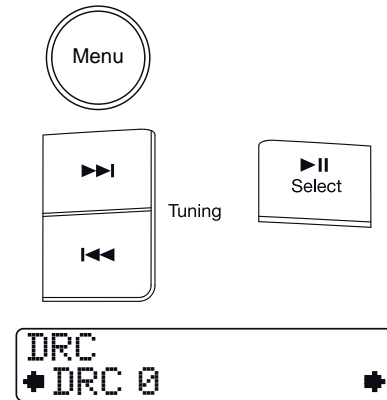

Prune stations - DAB

If you move to a different part of the country, some of the stations which were listed may no longer be available. Also, from time to time some DAB services may stop broadcasting, or may change location or frequency. Stations which cannot be found, or which have not been received for a very long time are shown in the station list with a question mark. The Prune stations function will delete the marked DAB stations from your station list.

- 1 When in DAB mode, press **Menu**.
- 2 Press **Tuning Up** or **Down** until 'Prune' is displayed. Press **Select**.
- 3 Press **Tuning Up** or **Down** until 'Yes' is highlighted. Press **Select** to cause invalid station names to be removed from the station list.
- 4 If you do not wish to prune stations choose 'No'.

Note: If you have moved your clock radio to a different part of the country you should also carry out a search for new stations.

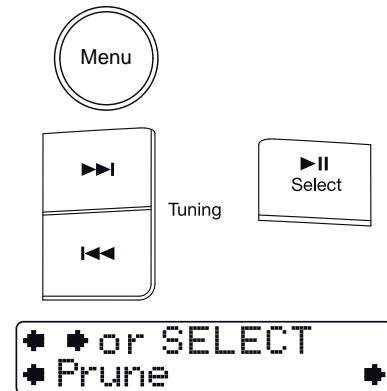

Search tuning - FM

- 1 Fully extend the **wire aerial**.
- 2 Press the **Mode** button until FM is selected.
- 3 **Give a long press** on **Tuning Up** or **Down** for several seconds. Your clock radio will scan upwards (low to high frequency) or downwards (high to low frequency) and will stop automatically when it finds a station of sufficient strength.
- 4 If the signal is strong enough and there is RDS data present then the radio will display the station name.
- 5 Adjust the **Volume**.

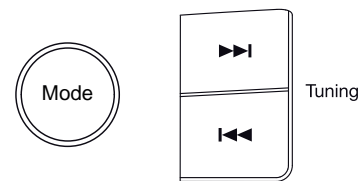

Manual tuning - FM

- 1 Press **Tuning Up** or **Down** buttons to tune to a station. The frequency will change in steps of 50 kHz.
- 2 Adjust the volume.

FM stereo / mono

- 1 If an FM station is received with a weak signal some hiss may be audible. To reduce the hiss, press the **Select** button. The display will show 'MONO'. Your radio will switch to mono mode.
- 2 To return to stereo mode press the **Select** button again the display will show 'AUTO'. The radio will switch to stereo mode.



Preset stations

You may store your preferred DAB and FM radio stations to the preset station memories. There are 40 memory presets in your clock radio, 20 DAB and 20 FM.

To store a preset station

- 1 Switch on your clock radio.
- 2 Press **Mode** to select DAB or FM and tune to the required station.
- 3 Press the **Prog/Preset** button.
- 4 Press **Preset Up** or **Down** to select the preset number where you wish to store the station.
- 5 Press the **Prog/Preset** button again. The display will show, e.g. 'Preset 03 Saved'. The station will be stored under the chosen preset. Stations which have been stored in preset memories may be overwritten by following the above procedure.

To recall a preset station

- 1 Press the **Mode** button to select DAB or FM.
- 2 Press **Preset Up** or **Down** to select the desired preset station. After several seconds your clock radio will automatically tune to the station stored.
Note: 'Empty' will be displayed if no station has been stored to that preset.

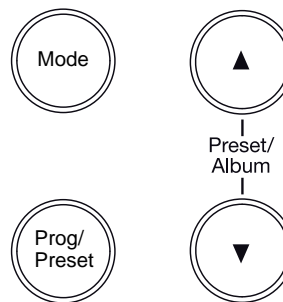

Empty
Preset 04

BBC Radio 4
Preset 03 Saved

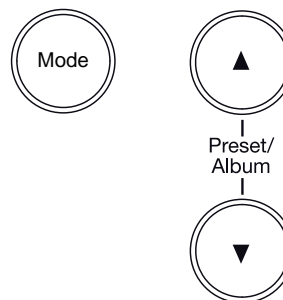

Bluetooth mode

The Bluetooth mode on your clock radio allows you to play audio, play sound from video files and stream music from Bluetooth capable devices such as your mobile phone, computer, tablet etc. through your clock radio's loudspeakers.

- When a Bluetooth enabled device such as your Sound 48 clock radio is in a 'discoverable' state other Bluetooth devices can detect, pair with or connect to it.
- 'Bluetooth pairing' occurs when two Bluetooth enabled devices agree to establish a connection and communicate with each other.

Connecting Bluetooth devices

- 1 Ensure that the Bluetooth capability on your phone, tablet or PC is enabled. You may need to refer to the user documentation for your device, since the method will vary with each device.
- 2 Ensure your clock radio is switched on.
- 3 Press the **Mode** button on your clock radio until the Bluetooth mode is selected. Your clock radio will become 'discoverable' and 'Connecting' will show on the display.
- 4 Using the Bluetooth settings on your phone, tablet or PC direct it to search for 'discoverable' devices. After a few seconds, you should see a device named 'Sound 48'. Just occasionally it may take longer for the clock radio to be found by your device.
- 5 Select 'Sound 48' to cause your phone, tablet or PC to pair with your clock radio and to establish a connection.

The connection will be established and you can now begin playing music from your smart-phone, tablet, etc.

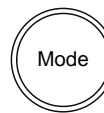

Some Bluetooth devices may require a 'Passkey' (an authentication key) in order to establish a link between devices. A passkey is similar to a password, although you only need to use the passkey once to establish a link. If your device asks for a passkey to be able to pair with your clock radio then enter a code of 0000 (four zeroes).



Playing audio files in Bluetooth mode

When you have successfully connected your clock radio with your chosen Bluetooth device you can start to play your music using the controls on the device.

- 1 Once playing has started adjust the volume to the required setting using the **Volume** control on your clock radio or the connected Bluetooth device.
- 2 The volume of your clock radio in Bluetooth mode is affected by the volume settings on the clock radio and also on the connected Bluetooth device.

If you adjust the volume control on the clock radio but you find that the volume is not sufficient, it may be that the volume setting of the connected device needs to be increased.

- 3 The audio player in your phone, tablet or PC may be able to respond to the **Play/Pause**, **Next** track and **Previous** track buttons on the clock radio. **Note:** Not all player applications or devices may respond to all of these buttons.

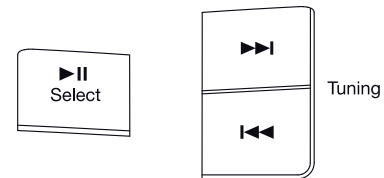

Connecting and reconnecting a Bluetooth device

You can only have one Bluetooth device connected to the clock radio at any one time. Once you have a Bluetooth enabled device connected to your clock radio it cannot be interrupted by another Bluetooth device unless you choose to break the connection.

- 1 To connect to a different device, **apply a long press** on the **Bluetooth Pair** button on the clock radio. Your Sound 48 clock radio will become 'discoverable' by other devices.
- 2 If you no longer want your Bluetooth device to be paired with your clock radio you will need to delete the 'Sound 48' pairing on the device. Please refer to the device's Bluetooth documentation.



Compact discs

Use only Digital Audio CDs which have the  symbol.

Never write on a CD or attach any sticker to the CD. Always hold the CD at the edge and store it in its box after use with the label facing up.

To remove dust and dirt, breathe on the CD and wipe it with a soft, lint free cloth in a straight line from the centre towards the edge.

Cleaning agents may damage the CD.

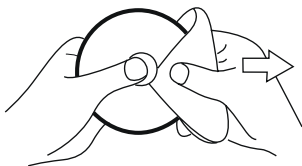

Do not expose the CD to rain, moisture, sand or to excessive heat. (e.g. from heating equipment or in motor cars parked in the sun).

CD-R/CD-RW discs

Your CD player can playback CD-DA format audio CD-R/CD-RW discs that have been finalised* upon completion of recording. Your CD player may fail to playback some CD-R/CD-RW discs due to poor recording and wide variation in quality of the CD-R/CD-RW disc.

*Finalising enables a CD-R/CD-RW disc to playback on audio players such as your Sound 48.

MP3 / WMA / AAC CD Mode

The Sound 48 is able to play CD-R and CD-RW discs containing MP3 / WMA / AAC files with a maximum of 255 files per folder. An MP3 / WMA / AAC CD should not contain more than a combined total of 999 files and folders. MP3, WMA and AAC files should be created with an audio sample rate of 44.1kHz (this is normal for files originally created from audio CDs). Folders may be nested but to a maximum of 8 levels. Folder and file names should ideally be less than 30 characters in length. Tags for title / artist / album information in the files should ideally be less than 30 characters in length. Within a folder, files or folders written earlier will generally be played before those written later and files have higher priority than nested folders.

There are many possible variations in the formatting of CD-R and CD-RW discs with audio files, but regular CD burning software should generally give good results with default settings. Should problems arise, contact the customer services of your CD burner or software manufacturer. When creating audio CDs, please observe all legal guidelines and ensure that the copyright of third parties is not infringed.

WARNING

CLASS 1 LASER PRODUCT means that the laser's construction makes it inherently safe so that the legally prescribed maximum permissible radiation values can never be exceeded.

Caution: Using any equipment or devices other than those described and specified in these operating instructions, or tampering with the unit in any way, can result in dangerous exposure to radiation.

**CLASS 1
LASER PRODUCT**



Inserting a CD

- 1 To open or close the CD compartment, press and release the right hand front corner on the top panel.
- 2 Put the CD on the spindle, print side facing upwards until it clicks into place and then gently close the CD compartment.

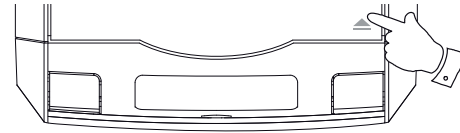

Playing a CD

- 1 Switch on your clock radio and press the **Mode** button until 'CD' is selected.
The CD player will scan the contents of the CD, "READING" will appear on the display.
Audio CD: the total number of tracks and total playing time will then be displayed.
MP3 / WMA / AAC CD: The total number of files and folders will then be displayed.
- 2 Press the **Play/Pause** button to start playback. The CD player will also show the first track number and the play symbol ▶.
Audio CD: The current track number and elapsed playing time.
MP3 / WMA / AAC CD: The display scrolls the following information: Folder, Title, Artist and Album.
- 3 Adjust the **Volume** to the required setting.
- 4 To pause playback press the **Play/Pause** button, the pause symbol || will appear on the display.
- 5 To continue playback press the **Play/Pause** button again.
- 6 To stop playback, press the **Stop** button.

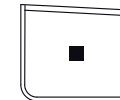
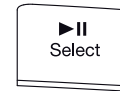
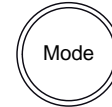

Note: The CD door should only be opened when the CD is in stop mode.



CD Bookmark

The CD Bookmark feature allows you to stop the playback of a CD and then to continue playback from the same point at a later time. Even if you put the clock radio into Standby mode or change the radio function, the next CD play operation will start from the point where playback was previously stopped.

Note: that if mains power is removed and restored the Bookmark setting will be cancelled and the CD will then play from the beginning.

- 1 When the CD is playing, press the **Stop** button once. The display will then show:

Audio CD: The current track number and 'RESUME'

MP3 / WMA / AAC CD: The file number and 'RESUME'

You can then put the clock radio into standby or select an alternative mode.

- 2 If you wish to cancel the Bookmark function, either press the **Stop** button a second time when the radio is in CD mode, or simply take out the CD.



Note: The Stop button must be pressed a second time to clear the resume memory.

Selecting a track

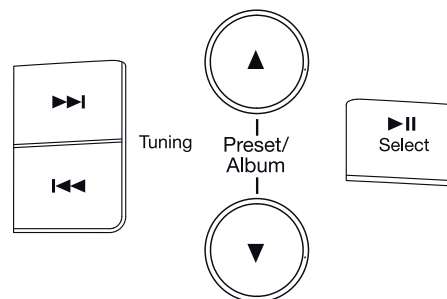

- 1 Audio CD: While the CD is playing, press **Fastforward** or **Rewind** to change the desired track. You can also skip to a track when the player is in stop mode. Press **Play/Pause**.
- 2 MP3 / WMA / AAC CD: While the CD is playing, press **Album Up** or **Down** buttons to change to the desired album/folder, then press **Fastforward** or **Rewind** to change to the desired track. You can also skip tracks when the player is in stop mode. Press **Play/Pause**.
- 3 To search to the desired part of the track, **give a long press** on the **Fastforward** or **Rewind** buttons.



CD Repeat function

- 1 Whilst the CD is playing press the **Intro / Repeat** button. The clock radio will step through the following options:

Audio CD: Repeat 1 , → Repeat ALL , → Normal Play

MP3 / WMA / AAC CD: Repeat 1 , → Repeat Folder , → Repeat ALL , → Normal Play

- 2 The display will show the currently selected repeat mode.



CD Intro function

- 1 When in the stop mode, press the **Intro / Repeat** button once to play the first 10 seconds of each of the tracks on the disc. 'INTRO' appears on the display.
- 2 To cancel the Intro mode, press and release the **Intro / Repeat** button as needed.



CD random play

- 1 While the CD is playing, press and release the **Random** button to play all tracks on the CD in random order. 'RAND' will appear on the display. The tracks are played in random order until all tracks have been played.
- 2 Press the **Random** button again to return to normal play. 'RAND' will disappear from the display.



Creating a playlist (program play)

By programming the player you can play up to 20 tracks in any desired order.

- 1 Whilst the CD is in Stop mode, press the **Prog / Preset** button to enter program mode. The display will show 'P-01'.

Select the first track using the **Tuning Up** or **Down** buttons. 'PROG' will flash on the display. Press and release the **Prog / Preset** button to store this track.

- 2 Repeat the above steps until you have completed your program.
- 3 Press the **Play / Pause** button to commence play of selected tracks.

Note: Programmable play order is available on original Audio CDs, and CDDA audio on CD-R or CD-RW discs only. The programmable play feature is not available with CDs containing MP3 / WMA / AAC audio files.



Tuning



Checking and editing a program

Whilst the CD is in play or pause modes, press the **Stop** button to enter program mode or to edit the current program.

- 1 Press the **Prog / Preset** button repeatedly. The display will show the play list that you have already programmed.
- 2 You can edit the playlist. When the desired track that you want to edit is reached, follow the procedure for creating a playlist above.



Erasing a program

- 1 Press the **Stop** button when in program mode to erase the program. Programs are also erased by putting the clock radio into to standby or radio mode. Pressing the Stop button twice when in play or pause modes also erases the program.

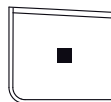

USB mode

This section describes how to use your clock radio to access and playback your audio files via USB memory devices.

The Sound 48 has been tested with a range of USB memory devices up to 32GB. However there are many different memory devices available and not all devices can be guaranteed to work in the Sound 48. Memory must use the FAT or FAT 32 filing system in order to operate in the Sound 48.

Important: Your clock radio is designed to work with USB flash memory devices. It is not intended to be connected to hard disk drives or any other type of USB device.

Audio formats supported on USB memory devices are MP3, AAC, WAV and FLAC.

The USB socket is located on the back of the unit.

Inserting and removing a USB memory device

Carefully insert a USB memory device into the USB socket. To remove the USB memory device simply pull the device out.

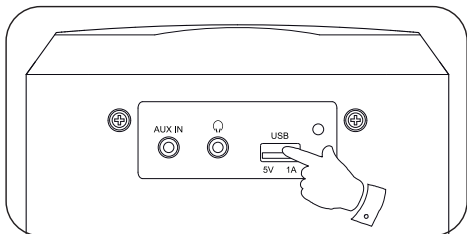

Selecting USB mode

- 1 To select the USB mode press the **Mode** button until 'USB' is selected.



Note: Playback control in USB mode is similar to CD-MP3/WMA/AAC mode (see pages 14-16). Files are played back in the order that they are written to the USB memory device by your computer except when random mode is used.

Note: The USB memory device should not be removed during playback as damage or corruption of files may occur.

Cautions

In order to minimise the risk of damage to your clock radio or USB memory device, please place the unit so that the device cannot be easily knocked while it is inserted in the socket.

Remove the USB memory device before carrying the unit or if not using the USB feature for a prolonged period.

Switch the unit off before removing your USB memory device.



Setting alarms

Your clock radio has 4 alarms which can be set to wake you by DAB, FM radio, USB, CD or beep type alarm. Each alarm can be set to sound, weekdays, weekends, everyday or once.

Note: The alarms can only be set with the clock radio in standby mode. Alarms will be retained in the event of a power failure. If no buttons are pressed for 30 seconds, the clock radio will exit the alarm setup.

- 1 When in standby mode, **give a long press** on the **Alarm** button.
 - 2 Press the **Preset/Album Up** or **Down** buttons to select the desired alarm 1, 2, 3 or 4.
 - 3 Press the **Alarm** button.
 - 4 Press the **Preset/Album Up** or **Down** buttons to select the desired alarm mode. Choose from OFF, BUZZER, DAB, USB, CD or FM mode. When the alarm mode is set to 'OFF' the alarm will be disabled.
 - 5 Press the **Alarm** button. The hour digits will flash on the display.
 - 6 Press **Preset/Album Up** or **Down** buttons to select the alarm hour. **Give a long press** on the **Up** or **Down** buttons to advance the time quickly.
 - 7 Press **Alarm**. Press **Preset/Album Up** or **Down** buttons to select the desired alarm minute.
 - 8 Press **Alarm** to confirm and to enter the alarm day option menu.
 - 9 Press **Preset/Album Up** or **Down** buttons to select the desired Alarm day option. Choose from WEEKDAYS, WEEKENDS, EVERYDAY or ONCE. If you set the alarm to ONCE you will also need to set the date.
 - 10 Press **Alarm** to confirm the setting. When the clock radio is in standby the alarm symbol  will appear if an alarm is set.
- When the alarm is set to wake by radio the last used station will be used and the alarm volume will be the previously listened to setting. The volume must not be set at the lowest level. The alarm will sound for 90 minutes unless cancelled. If a CD or USB is not present at the alarm time, the buzzer will be used instead.

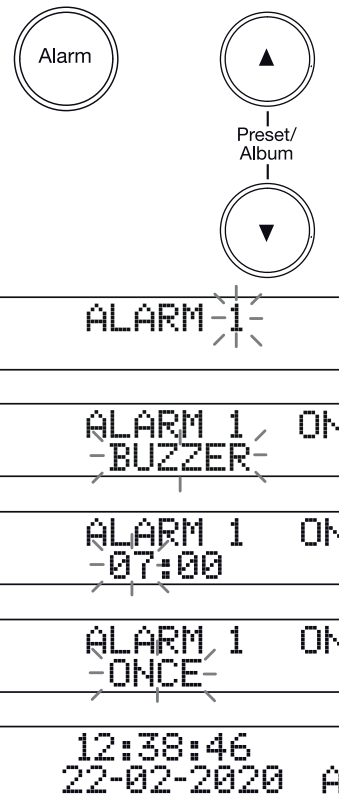

Snooze

- 1 Press the **Snooze** button to silence the alarm for the number of minutes specified.
- 2 To cancel snooze, press the **On / Off** button.
- 3 To adjust the snooze time, switch on the clock radio and select 'Snooze time' in the 'System' menu. Choose from 5, 10, 15, 20 minutes or OFF.

Cancel alarm

- 1 While an alarm is sounding it can be cancelled for 24 hours by pressing the **On / Off** button.
- 2 To permanently cancel an alarm, enter the alarm setup menu and set the alarm mode to the 'OFF' option.

Sleep

Your clock radio can be set to turn off after a preset time has elapsed.

- 1 Ensure your clock radio is switched on. Press **Sleep**. 'SLEEP' will appear on the display.
- 2 Repeatedly press and release the **Sleep** button to select the desired sleep time. The sleep setting will increase in 10 minute increments from 10 minutes up to 90 minutes. A further press will cause the sleep timer to be set to 0 which will cancel the sleep function.
- 3 During the sleep timer countdown period, press **Sleep** to view the remaining time as needed or to change the sleep timer setting.
- 4 Your clock radio will switch off after the preset sleep time has elapsed.
- 5 To cancel the sleep timer and switch off your clock radio before the chosen sleep time has elapsed, press the **On / Off** button.

To cancel the sleep timer and leave the clock radio switched on, repeatedly press and release the **Sleep** button to set the sleep timer to 0 minutes.

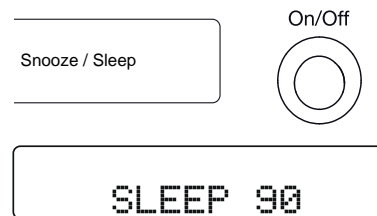
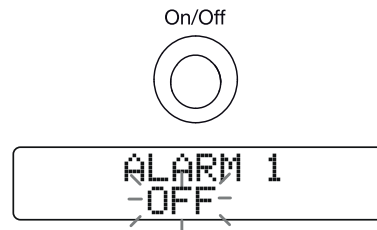
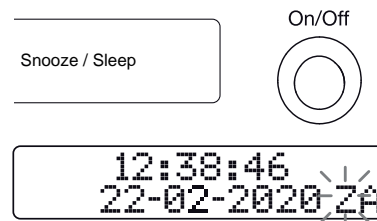

Automatically updating the clock

Your clock radio will usually set the clock time using the DAB signal. Alternatively you may set the clock manually.

- 1 Press **On/Off** to switch on your clock radio. Press **Menu**.
- 2 Using the **Tuning Up or Down** and **Select** buttons to choose 'System' (in DAB mode only), 'Time/Date', 'Auto Update' and then choose an update option from, DAB, FM No Update or Any. The current setting will be marked with an asterisk. Press **Menu** as needed to exit.

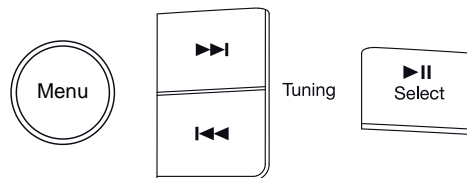

Setting the clock manually

If no DAB signal is available and you need to set the time manually, please follow the procedure shown below.

- 1 Press **On/Off** to switch on your clock radio. Press **Menu**.
- 2 Using the **Tuning Up** or **Down** and **Select** buttons to choose 'System' (in DAB mode only), 'Time/Date', 'Set Time/Date' and then select the hour, minute, day, month and year setting. Press **Menu** as needed to exit.



Language function

Your clock radio's menus can be configured to a different language.

- 1 Press **On/Off** to switch on your clock radio. Press **Menu**.
- 2 Using the **Tuning Up** or **Down** and **Select** buttons to choose 'System' (in DAB mode only), 'Language' and then your desired language. Press **Menu** as needed to exit.



Software version

The software display cannot be altered and is just for your reference. Ensure your clock radio is switched on.

- 1 Press **On/Off** to switch on your clock radio. Press **Menu**.
- 2 Using the **Tuning Up** or **Down** and **Select** buttons to choose 'System' (in DAB mode only), 'SW Version'. Press **Menu** as needed to exit.



System reset

If your clock radio fails to operate correctly, or some digits on the display are missing or incomplete carry out the following procedure.

- 1 Switch on your clock radio.
- 2 Press the **Menu** button.
- 3 Press **Tuning Up** or **Down** until 'System' (in DAB mode only) appears on the display. Press **Select**.
- 4 Press **Tuning Up** or **Down** until 'Factory Reset' appears on the display. Press **Select**.
- 5 Press **Tuning Up** or **Down** until 'Yes' is highlighted.
- 6 Press **Select**. A full reset will be performed. The station list, alarms and presets will be erased. The clock radio will restart.

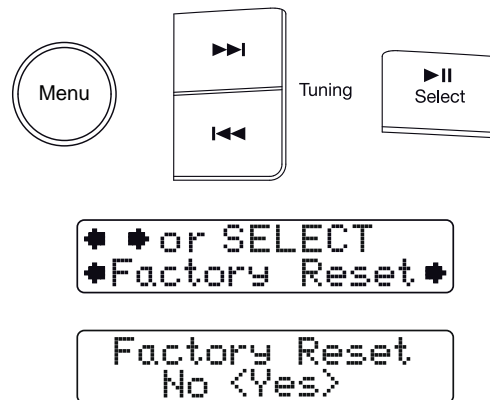

Headphone socket

A 3.5mm stereo **Headphone Socket** is provided on the rear of your clock radio for use with headphones. Inserting a plug automatically mutes the internal loudspeakers.

Please be aware that the sensitivity of headphones can vary widely. We therefore recommend setting volume to a low level before connecting headphones to the clock radio.

IMPORTANT: Excessive sound pressure from earphones and headphones can cause hearing loss.



To prevent possible hearing damage, do not listen at high volume levels for long periods.

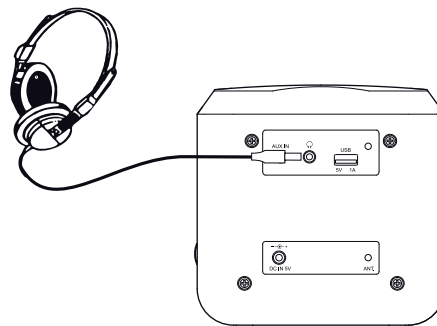

Auxiliary input (line in) socket

A 3.5mm stereo **Auxiliary Input socket** is provided on the rear of your clock radio to permit an audio signal to be fed into the unit from an external audio device such as iPod, MP3 or CD player.

- 1 Connect a stereo or mono audio source (for example, iPod, MP3 or CD player) to the **Auxiliary Input socket**.
- 2 Press the **Mode** button until the Auxiliary input mode is selected.
- 3 Adjust the **Volume control** on your iPod, MP3 or CD player to ensure an adequate signal and then adjust the volume on the clock radio for comfortable listening.

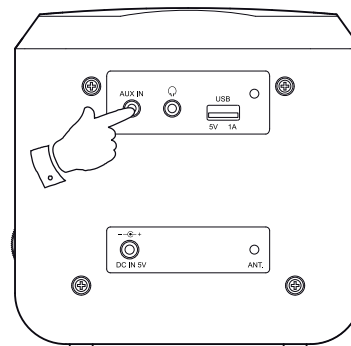
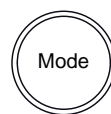

USB socket for smartphone or tablet charging

Your clock radio has a USB socket which can be used for charging a smartphone, tablet or other similar devices.

Charge time may vary and in some cases may take longer to charge than when using the manufacturers charging unit supplied with the device.

- 1 Ensure your clock radio is plugged in.
- 2 Connect your device to the USB charging socket on the back of your clock radio.
- 3 Your device will begin to charge. Once your device has charged remove the USB lead.

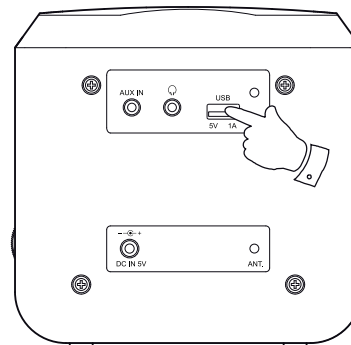

Bluetooth information

Bluetooth connectivity performance may vary depending on the connected Bluetooth devices. Please refer to the Bluetooth capabilities of your device before connecting to your clock radio. All features may not be supported on some paired Bluetooth devices.

A Bluetooth connection can provide a link for audio up to a distance of approximately ten metres. When pairing two Bluetooth enabled devices, for convenience, we recommend they should be no more than 2 to 3 metres apart. The presence of other functioning Bluetooth devices during connection may lead to operational difficulties.

Bluetooth is a short-range radio communication system and generally Bluetooth devices can communicate with each other clearly within a regular sized room or office. The reliability of a Bluetooth connection between different rooms will greatly depend upon the construction of the building.

Bluetooth communication range may be substantially reduced if the signal passes through a solid object. Human bodies, brick and concrete walls, heavy furniture or bookcases will all reduce the operational range of your Bluetooth devices to a greater or lesser extent. Glass, dry-wall or wood paneled walls and office partitions may have a less severe but noticeable effect. Metal pipes, foil-lined plasterboard, metal window frames and domestic wiring can also have an effect. You should position your Bluetooth devices closer to each other if you observe communication difficulties.

WiFi networks and cordless phones generally use similar radio frequencies to Bluetooth and may interfere with one another. If any interference is noticed, then try relocating the clock radio or one of the other devices.

The Bluetooth capabilities of your clock radio enable it to receive audio from many Bluetooth capable devices including mobile phones, personal computers and tablets. Only one Bluetooth device can be connected to your clock radio at a time. It supports the following Bluetooth profiles and functionality.

- Your clock radio supports A2DP (Advanced Audio Distribution Profile) which is a stereo audio connection that streams stereo music from PCs, mobile phones etc. SBC audio codec is supported.
- Your clock radio supports AVRCP (Audio Video Remote Control Profile) which allows your clock radio to control music playback from the connected device.

Note: Some mobile phones may temporarily disconnect from your clock radio when you make or receive calls. Some devices may temporarily mute their Bluetooth audio streaming when they receive text messages, emails or for other reasons unrelated to audio streaming. Such behaviour is a function of the connected device and does not indicate a fault with your clock radio.



Safety

Do not allow this clock radio to be exposed to water, steam or sand. Do not leave your clock radio where excessive heat could cause damage. It is recommended that the DAB band be used wherever possible as better results in terms of quality and freedom from interference will usually be obtained than on the FM band.

- The name plate is located on the underside of your clock radio.



Note: If the unit is in the CD, USB or Auxiliary input stop mode position for more than 15 minutes it will automatically switch to the standby mode. To use the unit again switch on the unit.

Electro-magnetic compatibility advice

In the event of a malfunction due to electrostatic discharge, mains power supply transients or short interruptions, reset the product to resume normal operation. If you are not able to perform the reset operation, removal and reconnection of the power supply may be required.

If the product is used in an environment with any ESD Immunity / Radiated Immunity / Conducted Immunity disturbance, the product may malfunction. It will automatically recover to normal when the ESD Immunity / Radiated Immunity / Conducted Immunity disturbance is stopped.

- The AC/DC adaptor or clock radio shall not be exposed to dripping or splashing and that no objects filled with liquids, such as vases, shall be placed on the AC/DC adaptor or clock radio.
- It is recommended to operate the product such that there is a minimum distance (10cm recommended) to adjacent objects in order to ensure good ventilation.
- The ventilation of the product should not be restricted by covering it or its ventilation openings with items such as newspapers, table-cloths, curtains etc.
- No naked flame sources such as lighted candles should be placed on the product.
- It is recommended to avoid using or storing the product at extremes of temperature. Avoid leaving the unit in cars, on window sills in direct sunlight etc.
- There are no user serviceable parts inside this product.
- Do not attempt to open or disassemble any part of the product.
- Operating temperature range +5°C to +40°C

Product markings

	This symbol indicates DC voltage.
	This symbol indicates AC voltage.
	Recycling This product bears the selective sorting symbol for Waste Electrical and Electronic Equipment (WEEE). This means that this product must be handled pursuant to European directive 2012/19/EU in order to be recycled or dismantled to minimize its impact on the environment. The user has the choice to give the product to a competent recycling organization or to the retailer when buying a new electrical or electronic equipment.



Specifications

Power Requirements

Mains (adaptor)	AC 100 - 240V \sim 50/60Hz
DC input	5V 1.5A centre pin positive (+)
USB	5V / 1A

For mains adaptor details see the quick start guide supplied with the product.

Circuit features

Headphone socket	3.5mm dia
Auxiliary input socket	3.5mm dia
Aerial System	FM Wire aerial
	DAB Wire aerial
Bluetooth standards	A2DP, AVRCP
Bluetooth codec supported	SBC

Frequency Coverage

FM	87.5-108MHz
DAB	174.928 - 239.200MHz
Bluetooth 5.0 frequencies	2.402 - 2.480 GHz, Power 2 dBm

The Company reserves the right to amend the specification without notice.



Guarantee

This product is guaranteed for twenty four months from the date of purchase by the original owner against failure due to faulty workmanship or component breakdown, subject to the procedure stated below. Should any component or part fail during this guarantee period it will be repaired or replaced free of charge.

The guarantee does not cover:

1. Damage resulting from incorrect use.
2. Consequential damage.
3. Product with removed or defaced serial numbers.

Procedure:

Any claim under this guarantee should be made through the dealer from whom the product was purchased. It is likely that your Roberts dealer will be able to attend to any defect quickly and efficiently, but should it be necessary the dealer will return the product to the company's service department for attention. In the event that it is not possible to return the product to the Roberts dealer from whom it was purchased, please contact Roberts Radio using the contact details on the www.robertsradio.com website.

For product repairs falling outside the guarantee period, please refer to the "customer care" tab on the www.robertsradio.com website.

These statements do not affect the statutory rights of a consumer.

ROBERTS RADIO LIMITED

PO Box 130
Mexborough
South Yorkshire
S64 8YT

www.robertsradio.com

© 2020 Roberts Radio Limited



Issue 1
2020-08-05

