

# PlayBt

DAB / DAB+ / FM / Bluetooth digital radio

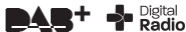

# ROBERTS



Please read this manual before use

# Contents

<i>Controls</i> .....	3-4
<i>Charging your radio</i> .....	5-6
<i>Keylock function</i> .....	7-8
<i>Display icons</i> .....	7-8
<i>Navigation</i> .....	9-10
<i>Operating your radio - DAB</i> .....	11-12
<i>Selecting a station - DAB</i> .....	13-14
<i>Display options - DAB</i> .....	15-18
<i>Finding new stations - DAB</i> .....	19-20
<i>Manual tuning - DAB</i> .....	23-24
<i>Dynamic range control settings - DAB</i> .....	25-26
<i>Station order setup - DAB</i> .....	27-28
<i>Prune stations - DAB</i> .....	29-30
<i>Operating your radio - Search tuning - FM</i> .....	31-32
<i>Manual tuning - FM</i> .....	33-34
<i>Display options - FM</i> .....	35-36
<i>FM stereo/mono (Earphones only)</i> .....	37-38

<i>Scan sensitivity setting - FM</i> .....	39-40
<i>Preset stations DAB and FM</i> .....	41-44
<i>Bluetooth mode</i> .....	45-46
<i>Connecting Bluetooth devices</i> .....	47-50
<i>Playing audio files in Bluetooth mode</i> .....	51-52
<i>Connecting &amp; Disconnecting Bluetooth</i> .....	53-56
<i>Bluetooth information</i> .....	57-58
<i>Clock settings</i> .....	59-66
<i>Equaliser</i> .....	67-72
<i>Contrast</i> .....	73-74
<i>Software version</i> .....	75-76
<i>Language</i> .....	77-78
<i>System reset</i> .....	79-80
<i>Earphones / Auxiliary input</i> .....	81-82
<i>General &amp; Safety precautions</i> .....	83-86
<i>Specifications &amp; circuit features</i> .....	87-88
<i>Guarantee</i> .....	90

## Controls

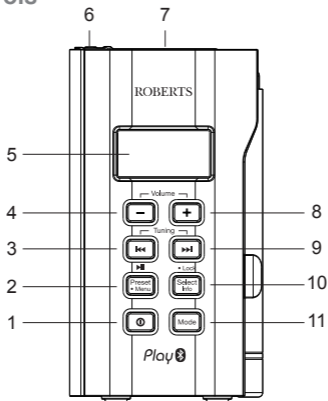

- |                                         |                             |
|-----------------------------------------|-----------------------------|
| 1. On/Off button                        | 7. Loudspeaker              |
| 2. Menu/Preset/Play/Pause button        | 8. Volume Up button         |
| 3. Tuning Down/Previous button          | 9. Tuning Up/Next button    |
| 4. Volume Down button                   | 10. Select/Info/Lock button |
| 5. LCD display                          | 11. Mode button             |
| 6. Earphone socket (under rubber cover) |                             |

## Controls

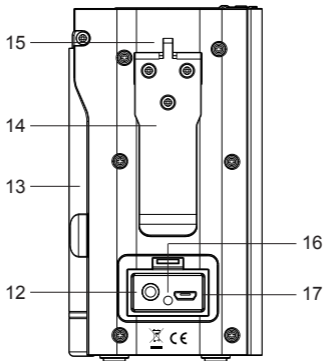

- 12. Auxiliary input socket (under rubber cover)
- 13. Antenna
- 14. Belt clip
- 15. Strap holder
- 16. LED charging indicator
- 17. Charging socket (under rubber cover)

## Charging your radio

The *PlayBt* features a built-in 1850mAh rechargeable Lithium battery to power your radio. Before operating the radio for the first time, ensure that you fully charge the radio.

1. Place your radio on a flat surface. Carefully pull back the protection cover and insert the adaptor plug into the **Charging socket** marked 'DC In' on the rear of your radio.
2. Plug the adaptor into a standard mains socket outlet. The radio will begin charging the built-in battery. During this time the **LED charging** indicator next to the charging socket will light brightly. Charging will take up to 4 hours. The radio can only be charged when the radio is switched off.
3. Charging is completed when the battery is fully charged. The **LED charging** indicator will then change from the bright level to very much dimmer level. It will remain at the dim level while the charger is connected to the radio and to the mains. The battery power icon will not be displayed on the LCD when charging.
4. Reduced power, distortion, 'stuttering' sounds or the low battery power indicator are all signs that the battery needs to be recharged.

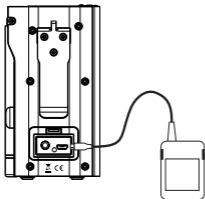

*The AC adaptor should be disconnected from the mains supply and the radio when not in use.*

**Note:** Never use, charge or operate the radio in rainy or moist conditions to prevent moisture entering the radio.

**IMPORTANT:** The mains adaptor is used as the means of connecting the radio to the mains supply. The mains socket used for the radio must remain accessible during normal use. In order to disconnect the radio from the mains completely, the mains adaptor should be removed from the mains socket outlet completely.

**Note:** The mains adaptor which is supplied with your radio is a high efficiency type, designed to minimise energy consumption, whether the radio is playing, charging its battery or switched off. Do not use any other mains adaptor in place of the unit supplied. Such use will invalidate your guarantee.

## Keylock function

The **Keylock function** is used to prevent unintentional operation of your radio.

1. When your radio is playing, press and hold the **Select / Lock** button for several seconds. *'Keys Locked'* will show on the display.
2. This will prevent accidental operation when your radio is being carried in a bag, pocket or when using the belt clip. If a button is accidentally pressed then *'Keys Locked'* will show on the display.
3. To disable the key lock function, press and hold the **Select / Lock** button again for several seconds until *'Keys Unlocked'* is shown on the display.

## Display icons

- |                              |                             |
|------------------------------|-----------------------------|
| a. Radio text                | d. Time (12/24 hr format)   |
| b. Battery indicator         | e. AM/PM indicator          |
| c. Signal strength indicator | f. Preset station indicator |



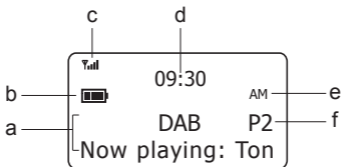
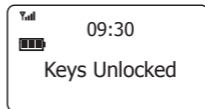
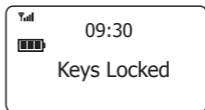
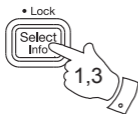

## Navigation

This page describes the basic means of controlling your *PlayBt*. Instructions for each operating mode are given in the later sections of this book.

1. Press and hold the **Menu** button to access the main menus.
2. Many operations require the user to make a selection from the menus. Press the **Tuning Up** or **Down** buttons until the desired menu item is displayed and then press and release the **Select** button to select that item. Arrows are used to show that there are more items in that menu.
3. If an error is made or you wish to go to the previous screen press and release the **Menu** button. The display will revert to the previous display with each press. After a period of inactivity the display will revert to the previous information display.

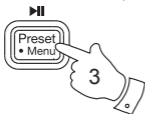
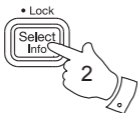
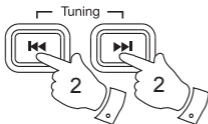
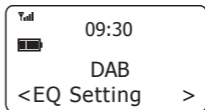
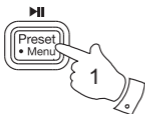

## Operating your radio - DAB

1. Carefully lift the antenna and position it vertically.
2. Press the **On/Off** button to switch on your radio. The display will show '*Welcome to Digital Radio*'.
3. If this is the first time the radio is used a scan of the Band III DAB channels will be carried out. If the radio has been used before the last used station will be selected.
4. During the scanning process, the lower line of the display shows a bar-graph indicating progress of the scan.
5. When the scanning is completed the first station (in numeric-alpha order 0...9...A....Z) will be selected. Your radio will automatically set to the current time.
6. If the station list is still empty after the scan your radio will display 'Service not available'.
7. If no signals are found it may be necessary to relocate your radio to a position giving better reception. Then, either switch your radio off and on again, or follow the procedure page 19 to repeat the scan.

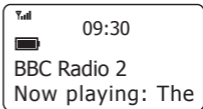
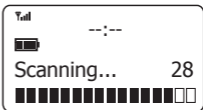
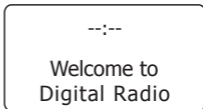
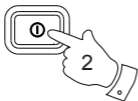

## Selecting a station - DAB

1. Press and release the **Mode** button until the DAB mode is selected.
2. The display shows the name of the station currently selected.
3. Press the **Tuning Up** or **Down** buttons to scroll through the list of available stations. Stop when you find the station that you wish to hear.
4. Press and release the **Select** button to select the station. The display may show '*Connecting...*' while your radio finds the new station.
5. Adjust the **Volume** to the required setting.

**Note:** If after selecting a station the display shows '*Service not available*' it may be necessary to relocate your radio to a position giving better reception.

The use of radio station presets for selecting your preferred radio stations is described on page 41.

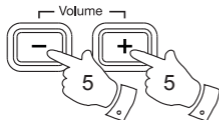
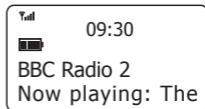
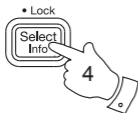
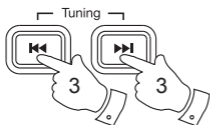
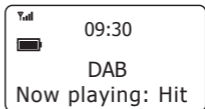

## Display options - DAB

When in DAB mode your radio has a range of display options:-

1. Press and release the **Select / Info** button to cycle through the various options.
  - a. Scrolling text                      Displays scrolling text messages such as artist /track name, phone in number etc.
  - b. Signal strength                      Displays DAB signal strength for station. For good reception the graph should occupy four or more blocks.
  - c. Program Type                      Displays the type of station being listened to e.g. Pop, Classic, News etc.
  - d. Multiplex Name                      Displays the name of DAB multiplex to which the current station belongs.



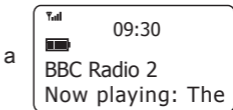





## Display options - DAB cont.

- |                        |                                                                                      |
|------------------------|--------------------------------------------------------------------------------------|
| e. Channel & frequency | Displays the channel and frequency of the DAB multiplex for the station listened to. |
| f. Bit rate            | Displays the digital bit rate for the station being listened to.                     |
| g. Audio type          | Displays the audio type for the station being listened to.                           |
| h. Date                | Displays the current date.                                                           |



e

 09:30  
  
BBC Radio 2  
12B 225.648MHz



f

 09:30  
  
BBC Radio 2  
128kbps / DAB

g

 09:30  
  
BBC Radio 2  
MP2

h

 09:30  
  
BBC Radio 2  
13- 4-2015

## Finding new radio stations - DAB

As time passes new stations may become available. To find new stations proceed as follows:-

1. Ensure your radio is in DAB mode. Press and hold the **Menu** button to enter the DAB menu.
2. Press the **Tuning Up** or **Down** buttons until '*Full scan*' is highlighted on the display.
3. Press and release the **Select** button. The display will show '*Scanning...*' and your radio will perform a scan of the Band III DAB channels.
4. As new radio stations are found the station counter on the right-hand side of the display will increase and the radio stations will be added to the list stored in the radio.

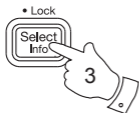
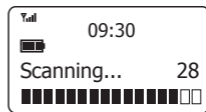
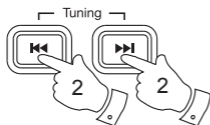
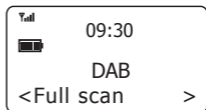
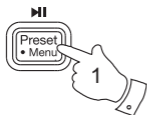

## Secondary services - DAB

1. Certain radio stations have one or more secondary services associated with them. The secondary service will then appear immediately after the primary service as you press the **Tuning Up** button.
2. Press and release the **Select** button to select the station.
3. When the secondary service shuts down, your radio will automatically switch back to the main radio station (or primary service) if it is available.

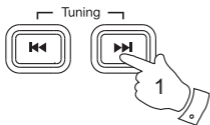

## Manual Tuning - DAB

Manual tuning allows you to tune directly to the various DAB Band III channels.

1. With your radio in DAB mode, press and hold the **Menu** button to enter the DAB menu.
2. Press the **Tuning Up** or **Down** buttons until '*Manual tune*' is highlighted. Press and release the **Select** button to enter manual tune.
3. Press the **Tuning Up** or **Down** buttons to highlight the desired channel.
4. Press and release the **Select** button. The signal strength indicator will indicate the signal strength. For good DAB reception the graph should occupy four or more blocks. Any stations found will be added to the stored list in the radio.
5. Press and release the **Select** button to return to the normal tuning mode.



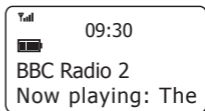
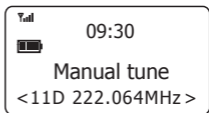
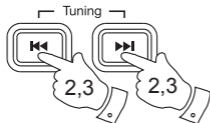
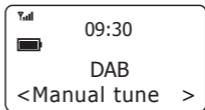
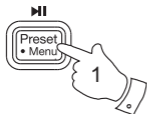

## Dynamic Range Control settings - DAB

Dynamic Range Control (also known as DRC) can make quieter sounds easier to hear when your radio is used in a noisy environment.

1. Press and release the **Mode** button until the DAB mode is selected.
2. Press and hold the **Menu** button.
3. Press the **Tuning Up** or **Down** buttons until 'DRC value' is highlighted on the display. Press the **Select** button to enter the DRC settings menu.
4. Press the **Tuning Up** or **Down** buttons to select the required DRC setting (the default is Off).

DRC Off - DRC is switched off, Broadcast DRC will be ignored. DRC Low - DRC level is set to half that sent by broadcaster. DRC High - DRC level is set as sent by broadcaster. The current DRC setting will be marked with an asterisk.

5. Press the **Select** button to confirm the setting. The display will return to the previous display.

**Note:** Not all DAB broadcasts are able to use the DRC function. If the broadcast does not support DRC, then the DRC setting in the radio will have no effect.

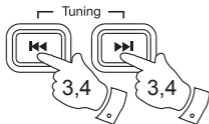
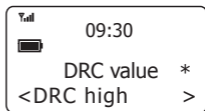
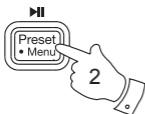
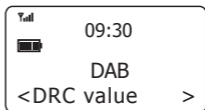

## Station order setup - DAB

Your radio has 3 station order settings from which you can choose. The station order settings are alphanumeric, ensemble and valid. **Note:** The default station order on your radio is alphanumeric.

1. Press and release the **Mode** button until the DAB mode is selected.
2. Press and hold the **Menu** button.
3. Press the **Tuning Up** or **Down** buttons until '*Station order*' is highlighted on the display. Press and release the **Select** button to enter the station order settings menu.
4. Press the **Tuning Up** or **Down** buttons to choose between '*Alphanumeric*', '*Ensemble*' and '*Valid*'.  
'Alphanumeric' - sorts the station list alpha-numerically 0...9, A...Z. 'Ensemble' - organises the station list by DAB multiplex. 'Valid' - shows only those stations for which a signal can be found. The current setting will be marked with an asterisk.
5. Press and release the **Select** button to confirm the setting. The display will return to the previous display.

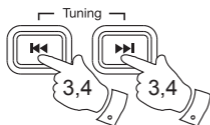
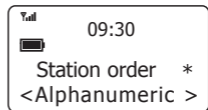
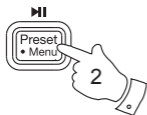
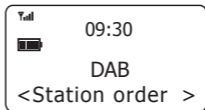

## Prune stations - DAB

Overtime, some DAB services may stop broadcasting, or may change location and then not be able to receive a station. In order to remove such stations from the DAB station list, the Prune stations function will delete the DAB stations from your station list that can no longer be received.

1. Press and release the **Mode** button until the DAB mode is selected.
2. Press and hold the **Menu** button.
3. Press the **Tuning Up** or **Down** buttons until '**Prune**' is highlighted on the display. Press and release the **Select** button.
4. Press the **Tuning Up** or **Down** buttons to highlight '**Yes**'.
5. Press and release the **Select** button to cause the stations list to be pruned, eliminating unavailable stations. If you do not wish to prune stations highlight '**No**' in step 4 and then press the **Select** button to confirm.

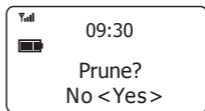
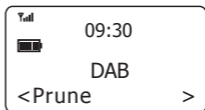
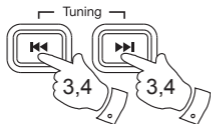
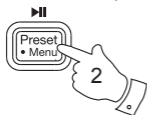

## Operating your radio - Search tuning - FM

1. Carefully lift the antenna and position it vertically. Press the **On/Off** button to switch on your radio.
2. Press and release the **Mode** button until the FM mode is selected.
3. Press and hold the **Tuning Up** button for 2 seconds, your radio will scan in an upwards direction (low frequency to high frequency) and stop automatically when it finds a station of sufficient strength.
4. After a few seconds the display will update. The display will show the frequency of the signal found. If the signal is strong enough and there is RDS data present then the radio may display the station name.
5. To find other stations, press the **Tuning Up** and hold as before.
6. To scan the FM band in a downwards direction (high frequency to low frequency) press and hold the **Tuning Down** button for 2 seconds.
7. When the waveband end is reached your radio will recommence tuning from the opposite waveband end. Adjust the **Volume** to the required setting.



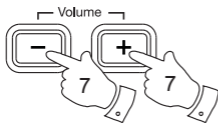
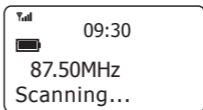
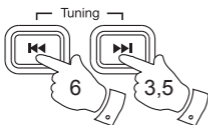

The use of radio station presets for selecting your preferred radio stations is described on page 41.

## Manual tuning - FM

1. Carefully lift the antenna and position it vertically for FM reception. Press the **On/Off** button to switch on your radio.
2. Press and release the **Mode** button until the FM mode is selected.
3. Press and release the **Tuning Up** or **Down** buttons to tune to a station. With each press the frequency will change up or down by 50 kHz.
4. When the waveband end is reached the radio will recommence tuning from the opposite waveband end.
5. Set the **Volume** to the desired settings.
6. To switch off your radio press the **On/Off** button.

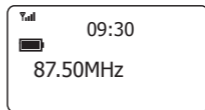
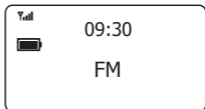
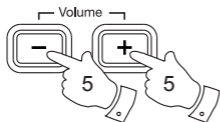
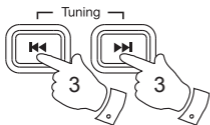
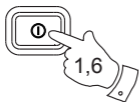

## Display options - FM

When in FM mode your radio has a range of display options:-

1. Press and release the **Select / info** button to cycle through each of the options.
  - a. Scrolling text      Displays scrolling text such as artist name, phone in number, etc.
  - b. Program type      Displays type of station being listened to e.g. Pop, Classic, News, etc.
  - c. Station name      Displays the station name.
  - d. Audio mode      Display shows stereo or Mono.
  - e. Date      Displays the current date.

**Note:** Your radio will display 'No Radio Text' on the lower line of the display if there is no scrolling text available and 'NO PTY' if there is no programme type information.

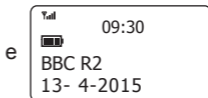
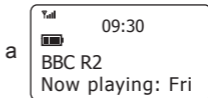
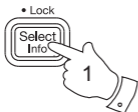

## FM Stereo/Mono (Earphones only)

If a station being received is weak some hiss may be audible (especially when listening using earphones).

1. When in FM mode, to reduce the hiss press and hold the **Menu** button.
2. Press the **Tuning Up** or **Down** buttons until '*FM Audio*' is highlighted on the display. Press and release the **Select** button.
3. Press the **Tuning Up** or **Down** buttons until '*Mono*' is highlighted on the display. Press and release the **Select** button. Your radio will select the mono audio mode.
4. To return to stereo mode, follow steps 1 and 2 above.
5. Press the **Tuning Up** or **Down** buttons until '*Auto*' is highlighted on the display. Press and release the **Select** button. Your radio will switch to stereo mode. The chosen setting will be marked with an asterisk.

**Note:** Stereo listening is only available when listening via earphones.

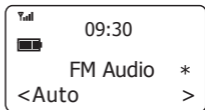
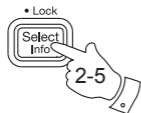
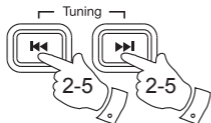
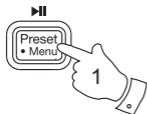

## Scan sensitivity setting - FM

Your radio includes a local / distant option for the Auto-scan function. By setting the radio to the 'local' scan option, weaker signals from more distant transmitters can be ignored by the radio, making stronger signals easier to find.

1. Press and release the **Mode** button until the FM mode is selected.
2. Press and hold the **Menu** button.
3. Press the **Tuning Up** or **Down** buttons until '*FM Scan Zone*' is highlighted on the display. Press and release the **Select** button to enter the scan sensitivity menu.
4. Press the **Tuning Up** or **Down** buttons to switch between '*Local*' (Strong stations only) and '*Distant*' (All stations) options. The Distant option will allow the radio to find weaker signals when scanning. The current setting will be marked with an asterisk.
5. Press and release the **Select** button to confirm the setting. The Local or Distant setting is stored in the radio and remains in force until changed or until a system reset.



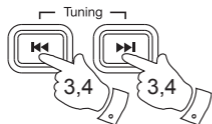
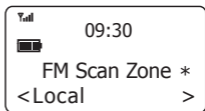
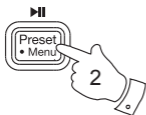
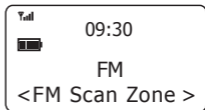

## Presetting stations

You may store your preferred DAB and FM radio stations to the preset station memories. There are 40 memory presets in your radio, 20 for DAB and 20 for FM. Presets are remembered by your radio in the event of a power failure. The procedure for setting presets and using them to tune stations is the same for FM and DAB modes, and is described below.

1. Press the **On/Off** button to switch on the radio.
2. Select the desired waveband and tune to the required station as previously described.
3. Press and release the **Menu** button twice. *'MEM Store'* will be displayed.
4. Press and release the **Select** button. The display shows, for example, *'P2 Saved'*. Your radio will store the station in the next available memory preset. Repeat this procedure as needed.
5. If you wish to choose a preset number to store your station, follow steps 1-3 above and then press and release the **Tuning Up** or **Down** buttons to select the desired preset number under which you wish to store the station. The Preset number will show on the display.

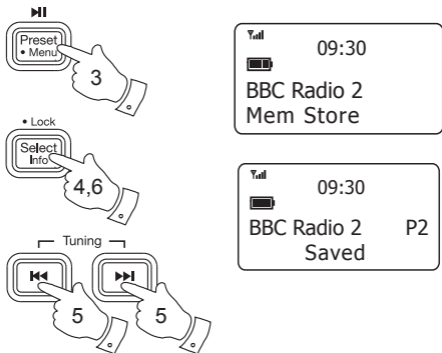

6. Press and release the **Select** button. The display shows, for example, 'Saved'. The station will be stored under the chosen preset. Repeat this procedure as needed.
7. Stations which have been stored in preset memories may be overwritten by following the above procedure.

## Recalling a preset

1. Press the **On/Off** button to switch on the radio.
2. Select the desired waveband.
3. Press and release the **Menu** button. '*MEM Browse*' will be displayed.
4. Press and release the **Tuning Up** or **Down** buttons to select the desired preset station.
5. Press and release the **Select** button to tune to the preset station.

**Note:** You can only recall a station that has previously been stored.

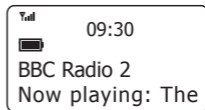
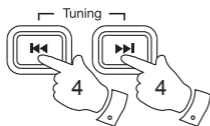
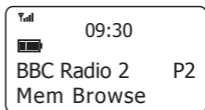
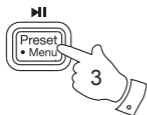

## Bluetooth mode

The Bluetooth mode on your radio allows you to play audio, play sound from video files and stream music from Bluetooth capable devices such as your mobile phone, computer, tablet etc. through your radio's loudspeaker.

- When a Bluetooth enabled device such as your *PlayBt* radio is in a 'discoverable' state other Bluetooth devices can detect, pair with or connect to it.
- 'Bluetooth pairing' occurs when two Bluetooth enabled devices agree to establish a connection and communicate with each other.
- ***Your radio will display 'Bluetooth discoverable' on the display when it is discoverable or when it is trying to connect to a previously paired Bluetooth device. When a device is paired with and connects to your radio, the Bluetooth indicator 'BT' will remain on the display.***

Bluetooth connectivity performance may vary depending on the connected Bluetooth devices. Please refer to the Bluetooth capabilities of your device before connecting to your radio. All features may not be supported on some paired Bluetooth devices.

A Bluetooth connection can provide a link for audio up to a distance of approximately ten metres. When pairing two Bluetooth enabled devices, for convenience, we recommend they should be no more than 2 to 3 metres apart. The presence of other functioning Bluetooth devices during connection may lead to operational difficulties.

Bluetooth is a short-range radio communication system and generally Bluetooth devices can communicate with each other clearly within a regular sized room or office. The reliability of a Bluetooth connection between different rooms will greatly depend upon the construction of the building.

## Connecting Bluetooth devices

1. Ensure that the Bluetooth capability on your phone, tablet or PC is enabled. You may need to refer to the user documentation for your device, since the method will vary with each device.
2. Press and release the **On / Off** button to switch on the radio.
3. Press and release the **Mode** button on your radio until the Bluetooth mode is selected. Your radio will show that it is 'discoverable' by showing '*Bluetooth discoverable...*' on the display.
4. Using the Bluetooth settings of your phone, tablet or PC direct it to search for 'discoverable' devices. After a few seconds, you should see a device named '**Play BT**'. Just occasionally it may take longer for the radio to be found by your device.



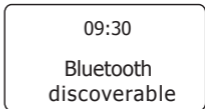
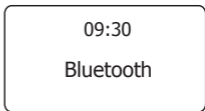
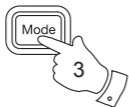
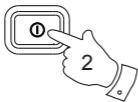

## Connecting Bluetooth devices cont.

5. Select '**Play BT**' to cause your phone, tablet or PC to pair with your radio and to establish a connection.
6. Once the connection is established a message will be displayed briefly confirming connection and the name of the connected device. The Bluetooth indicator '**BT**' will remain on the display whilst Bluetooth is connected.

You can now begin playing music from your smart-phone, tablet, etc.

Some Bluetooth devices may require a 'Passkey' (an authentication key) in order to establish a link between devices. A passkey is similar to a password, although you only need to use the passkey once to establish a link. If your device asks for a passkey to be able to pair with your radio then enter a code of 0000 (four zeroes).

09:30

BT connected:  
Julia's iPod tou

09:30

▶ 01:15 BT  
Edgar Froese

## Playing audio files in Bluetooth mode

When you have successfully connected your radio with your chosen Bluetooth device you can start to play your music using the controls on the device.

1. Once playing has started adjust the volume to the required setting using the **Volume** buttons on your radio or the connected Bluetooth device.
2. The volume of your radio in Bluetooth mode is affected by the volumes setting on the radio and also on the connected Bluetooth device. If you adjust the volume on the radio but you find that the volume from the radio is not sufficient, it may be that the volume setting of the connected device needs to be increased.
3. The audio player in your phone, tablet or PC may be able to respond to the **Play/Pause**, **Next** track and **Previous** track buttons on the radio.  
**Note:** Not all player applications or devices may respond to all of these buttons.
4. If your connected device is able to provide information from the track being played, you may press and release the **Select/Info** button to display the Title, Album, Artist, Format and date details on the display.

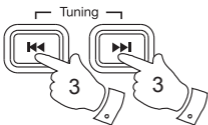
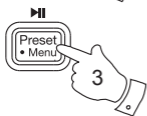
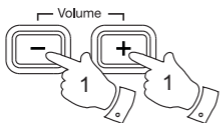

09:30  
▶ 01:15 BT  
Magic lantern

09:30  
▶ 01:15 BT  
Beyond the Storm

09:30  
▶ 01:15 BT  
Edgar Froese

09:30  
▶ 01:15 BT  
AAC 44100Hz

09:30  
▶ 01:15 BT  
13- 4-2015

## Connecting and disconnecting a Bluetooth device

You can only have one Bluetooth device connected to the radio at any one time although it may be paired with several devices. Once you have a Bluetooth enabled device connected to your radio it cannot be interrupted by another Bluetooth device unless you choose to break the connection.

1. To connect to a new device, press and hold the **Menu** button to access the menu options.
2. Press and release the **Tuning Up** or **Down** buttons until the display shows '*Discoverable*'.
3. Press the **Select** button. The radio will then be discoverable by other devices. The radio will remain discoverable while the display shows '*Bluetooth discoverable*'.
4. You may then pair the radio with the new device using its Bluetooth settings (the radio will be listed on the device as '**Play BT**'). The name of the newly connected device will be briefly shown on the radio's display. You may then play music from the new device through the radio.

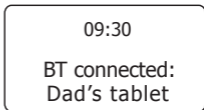
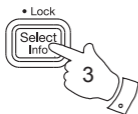
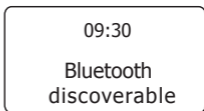
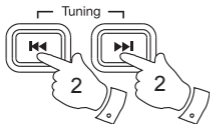
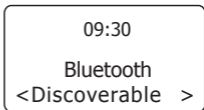
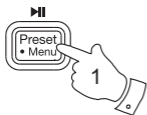

## Connecting and disconnecting a Bluetooth device cont.

5. To connect to a previously paired device, press and hold the **Menu** button on the radio to access the menu options.
6. Press and release the **Tuning Up** or **Down** buttons until the display shows 'Device list'.
7. Press the **Select** button.
8. Press and release the **Tuning Up** or **Down** buttons to step through a list of previously connected devices.
9. To connect to a previously connected device, press and release the **Select** button when the device's name is displayed. The radio will then connect to the device. If automatic reconnection fails, then you will generally be able to connect simply by selecting the '**Play BT**' pairing in your device's Bluetooth settings.
10. If you no longer want your Bluetooth device to be paired with your radio you will need to delete the '**Play BT**' pairing on the device. Please refer to the device's Bluetooth documentation.



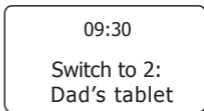
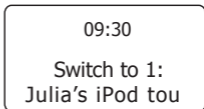
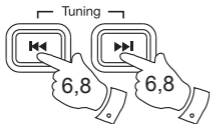
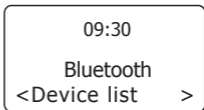
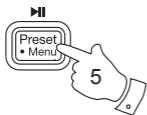

## Bluetooth information

Bluetooth communication range may be substantially reduced if the signal passes through a solid object. Human bodies, brick and concrete walls, heavy furniture or bookcases will all reduce the operational range of your Bluetooth devices to a greater or lesser extent. Glass, dry-wall or wood paneled walls and office partitions may have a less severe but noticeable effect. Metal pipes, foil-lined plasterboard, metal window frames and domestic wiring can also have an effect. You should position your Bluetooth devices closer to each other if you observe communication difficulties.

WiFi networks and cordless phones generally use similar radio frequencies to Bluetooth and may interfere with one another. If any interference is noticed, then try relocating the radio or one of the other devices.

The Bluetooth capabilities of your radio enable it to receive audio from many Bluetooth capable devices including mobile phones, personal computers and

tablets. Only one Bluetooth device can be connected to your radio at a time. It supports the following Bluetooth profiles and functionality.

- Your radio supports A2DP (Advanced Audio Distribution Profile) which is a stereo audio connection that streams stereo music from PCs, mobile phones etc. SBC and AAC audio codecs are supported.
- Your radio supports AVRCP (Audio Video Remote Control Profile) which allows your radio to control music playback from the connected device.

**Note:** Some mobile phones may temporarily disconnect from your radio when you make or receive calls. Some devices may temporarily mute their Bluetooth audio streaming when they receive text messages, emails or for other reasons unrelated to audio streaming. Such behaviour is a function of the connected device and does not indicate a fault with your radio.

## Automatically updating the clock

Your radio will usually set the clock time using the DAB time signal. You may specify that the radio sets its clock from the DAB or FM waveband, either waveband or none. If you choose none you will need to set the clock manually.

1. Press the **On/Off** button to switch on the radio.
2. Press and hold the **Menu** button.
3. Press the **Tuning Up** or **Down** buttons until 'System' is highlighted on the display. Press and release the **Select** button.
4. Press the **Tuning Up** or **Down** buttons until 'Time' is highlighted on the display. Press and release the **Select** button.
5. Press the **Tuning Up** or **Down** buttons until 'Auto update' is highlighted on the display. Press and release the **Select** button.
6. Press the **Tuning Up** or **Down** buttons to choose an update option from, 'Any', 'DAB', 'FM' or 'No Update'.
7. Press and release the **Select** button to confirm. The radio will set its time according to the information received.

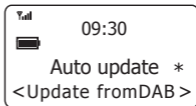
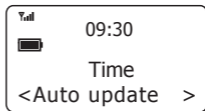
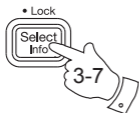
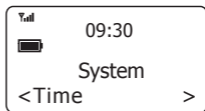
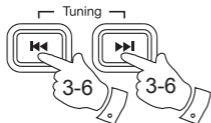
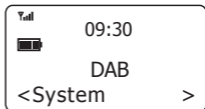
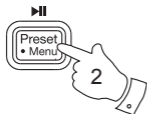

## Setting the clock format

The clock display can be set to 12 or 24 hour format.

1. Press the **On/Off** button to switch on the radio.
2. Press and hold the **Menu** button.
3. Press the **Tuning Up** or **Down** buttons until 'System' is highlighted on the display. Press and release the **Select** button.
4. Press the **Tuning Up** or **Down** buttons until 'Time' is highlighted on the display. Press and release the **Select** button.
5. Press the **Tuning Up** or **Down** buttons until 'Set 12/24 hour' is highlighted on the display.
6. Press and release the **Select** button. The current setting will be marked with an asterisk.
7. Press the **Tuning Up** or **Down** buttons to select either 12 or 24 hour format.
8. Press and release the **Select** button to confirm the setting.

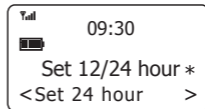
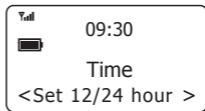
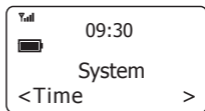
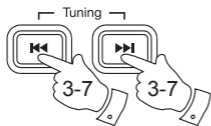
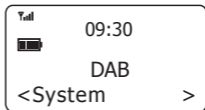
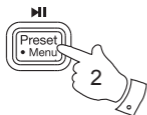

## Setting the clock manually

Normally your radio will set its clock automatically using the DAB radio signal. If no DAB signal is available and you need to set the time manually, please follow the procedure shown below.

1. Press the **On/Off** button to switch on the radio.
2. Press and hold the **Menu** button.
3. Press the **Tuning Up** or **Down** buttons until 'System' is highlighted on the display. Press and release the **Select** button.
4. Press the **Tuning Up** or **Down** buttons until 'Time' is highlighted on the display. Press and release the **Select** button.
5. Press the **Tuning Up** or **Down** buttons until 'Set Time/Date' is highlighted on the display.
6. Press and release the **Select** button. The hour will flash on the display.
7. Press the **Tuning Up** or **Down** buttons to set the current hour.
8. Press and release the **Select** button. The minutes will flash on the display.



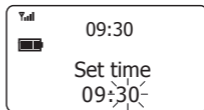
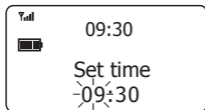
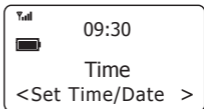
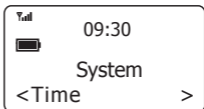
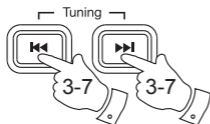
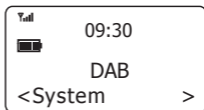
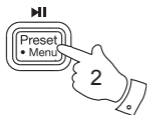

## Setting the clock manually cont.

9. Press the **Tuning Up** or **Down** buttons to set the current minutes.

If the radio has been set to use 12 hour format, there will be an option for setting AM or PM for the clock time. Use the **Tuning Up** or **Down** buttons and the **Select** button to set AM or PM.

10. Press and release the **Select** button. The day of the month will flash.
11. Press the **Tuning Up** or **Down** buttons to set the current day.
12. Press and release the **Select** button. The month digits will flash.
13. Press the **Tuning Up** or **Down** buttons to set the current month.
14. Press and release the **Select** button. The year digits will flash.
15. Press the **Tuning Up** or **Down** buttons to set the current year.
16. Press and release the **Select** button to confirm time and date settings. 'Time Saved' will be displayed.

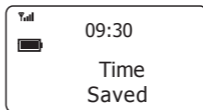
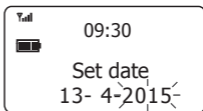
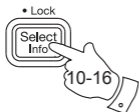
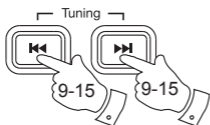

## Equaliser function

The sound on your radio can be adjusted to suit your personal taste for the material that you are listening to. The **PlayBT** has a range of equaliser options. Alternatively you may set the treble and bass levels to your own preferences which can be accessed from the '*Personal*' menu item.

1. Press the **On/Off** button to switch on the radio and then press and hold the **Menu** button.
2. Press the **Tuning Up** or **Down** buttons until '*EQ Setting*' is highlighted on the display.
3. Press and release the **Select** button to enter the EQ menu.
4. Press the **Tuning Up** or **Down** buttons to cycle through and highlight the various options. Press the **Select** button to confirm your selection.
  - a - 'Normal'
  - b - 'Rock'
  - c - 'Soul & Jazz'
  - d - 'Classical'
  - e - 'Spoken word'
  - f - 'Personal'

The currently selected option is marked with an asterisk.

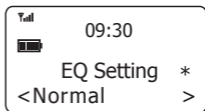
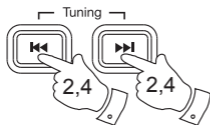
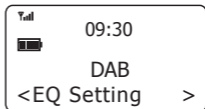
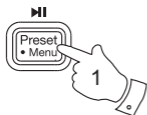

## Setting up your personal profile

If you find the preset equaliser functions not to your liking, you may set up a custom treble and bass setting as follows:

1. Follow steps 1-3 on the preceding page in order to enter the Equaliser menu.
2. Press the **Tuning Up** or **Down** buttons until '*Personal*' is highlighted on the display. Press and release the **Select** button to enter the adjustment mode.
3. To adjust the treble level, press the **Tuning Up** or **Down** buttons until '*Treble*' is highlighted on the display.
4. Press the **Select** button to enter adjustment mode and press the **Tuning Up** or **Down** buttons until the desired level (between -5 and +5) is displayed. The sound will change as you adjust the level.
5. Press and release the **Select** button when you are happy with the treble setting.

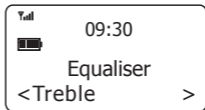
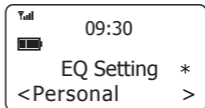
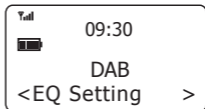
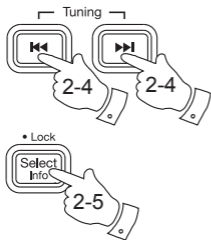

## Setting up your personal profile cont.

6. To adjust the bass level, press the **Tuning Up** or **Down** buttons until 'Bass' is highlighted on the display.
7. Press the **Select** button to enter adjustment mode and press the **Tuning Up** or **Down** buttons until the desired level (between -5 and +5) is displayed. The sound will change as you adjust the level.
8. Press and release the **Select** button when you are happy with the bass setting.
9. To quickly cancel the effect of the 'Personal' setting press the **Tuning Up** or **Down** buttons until 'Normal' is highlighted and press and release the **Select** button. The treble and bass settings will be remembered for the next time that you wish to use the 'Personal' setting.



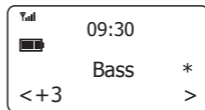
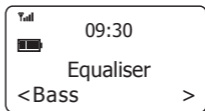
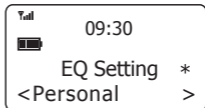
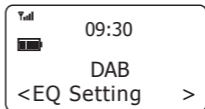
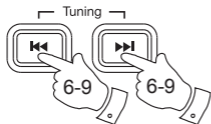

## Contrast

The contrast of the display can be adjusted on your radio.

1. To adjust the contrast, press and hold the **Menu** button.
2. Press the **Tuning Up** or **Down** buttons until 'System' is highlighted on the display.
3. Press and release the **Select** button.
4. Press the **Tuning Up** or **Down** buttons until 'Contrast' is highlighted on the display.
5. Press and release the **Select** button.
6. Press the **Tuning Up** or **Down** buttons to adjust the contrast level (between 1 and 16). The contrast level indication on the screen will change at the same time.
7. When you find the setting that gives you the best legibility for the location in which the radio is used, press and release the **Select** button to save the setting.

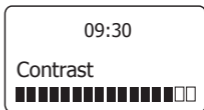
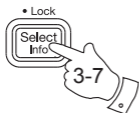
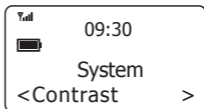
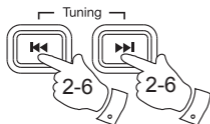
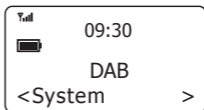
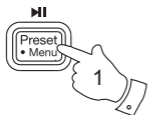

## Software version

The software display cannot be altered and is just for your reference.

1. Switch on your radio and then press and hold the **Menu** button.
2. Press the **Tuning Up** or **Down** buttons until 'System' is highlighted on the display.
3. Press and release the **Select** button.
4. Press the **Tuning Up** or **Down** buttons until 'SW version' is highlighted on the display.
5. Press and release the **Select** button. The software version will appear on the display.
6. Press and release the **Menu** button to exit the software display.

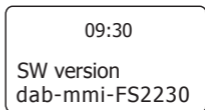
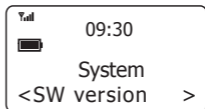
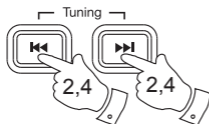
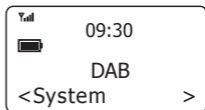

## Language

Your radio's menus may be configured to a different language.

1. Switch on your radio and press and hold the **Menu** button.
2. Press the **Tuning Up** or **Down** buttons until 'System' is highlighted on the display.
3. Press and release the **Select** button.
4. Press the **Tuning Up** or **Down** buttons until 'Language' is highlighted on the display.
5. Press and release the **Select** button to enter the language adjustment menu.
6. Press the **Tuning Up** or **Down** buttons until your desired language appears on the display.
7. Press and release the **Select** button to confirm your choice. The display will change to the chosen language.

The chosen language will be marked with an asterisk.

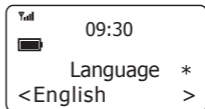
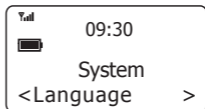
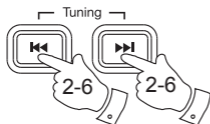
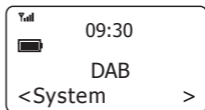
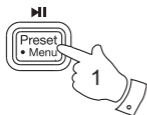

## System reset

If your radio fails to operate correctly, or some digits on the display are missing or incomplete carry out the following procedure. Your radio will automatically re-scan for the DAB stations available at your current location when it restarts.

1. Switch on your radio. Press and hold the **Menu** button to enter the menu.
  2. Press the **Tuning Up** or **Down** buttons until 'System' is highlighted on the display. Press and release the **Select** button.
  3. Press the **Tuning Up** or **Down** buttons until 'Factory Reset' is highlighted on the display. Press and release the **Select** button.
  4. If you wish to perform the reset operation, press the **Tuning Up** or **Down** until 'Yes' is highlighted on the display and press and release the **Select** button. A full reset of your radio will be performed. All presets and station lists will be erased.
- If you do not wish to reset your radio press the **Tuning Up** or **Down** until 'No' is highlighted and then press and release the **Select** button. Your radio will exit the menu.



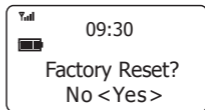
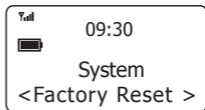
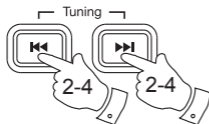
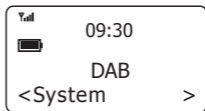
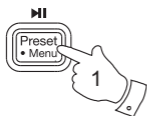

5. After a system reset a scan of the DAB band will be performed.

In case of malfunction due to electrostatic discharge, reset the product (temporary disconnection of the power adaptor may be required) to resume normal operation.

## Earphone socket

A 3.5mm **Earphone** Socket located on the top of your radio is provided for use with either headphones or an earpiece. Inserting a plug automatically mutes the internal loudspeaker.

Please be aware that the sensitivity of headphones can vary widely. We therefore recommend setting the volume to a low level before connecting headphones to the radio.

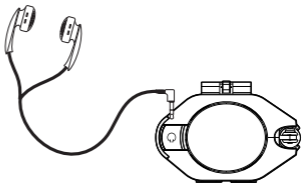

**IMPORTANT:** Excessive sound pressure from earphones and headphones can cause hearing loss.



To prevent possible hearing damage, do not listen at high volume levels for long periods.

## Auxiliary input socket

1. Connect a stereo or mono audio source (i.e. CD player, MP3 player etc. to the **Auxiliary input** socket.
2. Press and release the **On/Off** button to switch on the radio. Press and release the **Mode** button until the display shows '**Auxiliary Input**'.
3. Adjust the Volume on your player and on the radio for comfortable listening.



**Note:** Never use the Aux-In socket in rainy or moist conditions to prevent moisture entering the radio.

## General

Do not allow this radio to be exposed to water, steam or sand. Do not leave your radio where excessive heat could cause damage such as in a parked car where the heat from the sun can build up even though the outside temperature may not seem too high. It is recommended that the DAB band be used wherever possible as better results in terms of quality and freedom from interference will usually be obtained than on the FM band.

The name plate is located underneath the radio.



- Your AC/DC adaptor and radio should not be exposed to dripping or splashing and that no objects filled with liquids, such as vases, shall be placed on the AC/DC adaptor or the radio.
- It is recommended to operate the product such that there is a minimum distance (10cm recommended) to adjacent objects in order to ensure good ventilation.
- The ventilation of the product should not be restricted by covering it with items such as newspapers, tablecloths, curtains etc.
- No naked flame sources such as lighted candles should be placed on the product.
- It is recommended to avoid using or storing the product at extremes of temperature. Avoid leaving the unit in cars, on window sills, in direct sunlight etc.

## Safety precautions

There are no user serviceable parts inside this product.

Do not attempt to disassemble any part of the product.

Do not use or charge the battery if it appears to be abnormally hot, swollen, leaking or damaged in any way.

Do not leave a charging battery unattended.

If the product is supplied with a charger, then the product should only be used with that charger, or a genuine replacement provided by Roberts Radio. Do not use any alternative power source as a charger.

Check the room temperature range is between 0-40°C (32-104°F) before charging the product/ battery.

Do not puncture, crush, modify, or cause any unnecessary shock to the battery. The battery may present a risk of fire, explosion or chemical burn if mistreated.

Do not dispose of the battery in a fire or incinerator.

Do not leave, charge or expose the battery to a heat source such as in a car under direct sunlight.

Do not expose the battery to moisture.

## Specifications

**Power Requirement** Mains (via adaptor)  
AC 100 ~ 240V 50/60Hz DC 5V 500 mA

Lithium rechargeable battery 3.7V / 1850 mAh

### **Battery life full charge**

4-10 hours using the speaker at normal volume.

6-15 hours using earphones at normal volume.

### **Frequency Coverage**

FM 87.5-108MHz, DAB 174.928 -239.200MHz

The Company reserves the right to amend the specification without notice.



## Circuit Features

Loudspeaker	36 mm
Output Power	1W (speaker)
Earphone socket	3.5mm dia. stereo
Aux Input socket	3.5mm dia. stereo

### Aerial System

FM	Helical antenna
DAB	Helical antenna

## Notes

.....

.....

.....

.....

.....

.....

.....

.....

.....

.....

.....

.....

.....

.....

.....

.....

.....

.....

.....

.....

.....

.....

.....

## Guarantee

This product is guaranteed for twelve months from the date of purchase by the original owner against failure due to faulty workmanship or component breakdown, subject to the procedure stated below. Should any component or part fail during this guarantee period it will be repaired or replaced free of charge.

The guarantee does not cover: 1. Damage resulting from incorrect use. 2. Consequential damage. 3. Product with removed or defaced serial numbers. N.B. Damaged or broken aerials will not be replaced under guarantee.

Procedure: Any claim under this guarantee should be made through the dealer from whom the product was purchased. It is likely that your Roberts dealer will be able to attend to any defect quickly and efficiently, but should it be necessary the dealer will return the product to the company's service department for attention. In the event that it is not possible to return the product to the Roberts dealer from whom it was purchased, please contact Roberts Radio using the contact details on the [www.robertsradio.com](http://www.robertsradio.com) website.

For product repairs falling outside the guarantee period, please refer to the 'customer care' tab on the [www.robertsradio.com](http://www.robertsradio.com) website.

*These statements do not affect the statutory rights of a consumer.*

# ROBERTS RADIO LIMITED

PO Box 130  
Mexborough  
South Yorkshire  
S64 8YT



Website: <http://www.robertsradio.com>