

# ROBERTS

Sound for Generations

## MP-24

DAB / FM RDS / CD / SD Sound System with MP3 / WMA playback facility

**MP-SOUND 24**

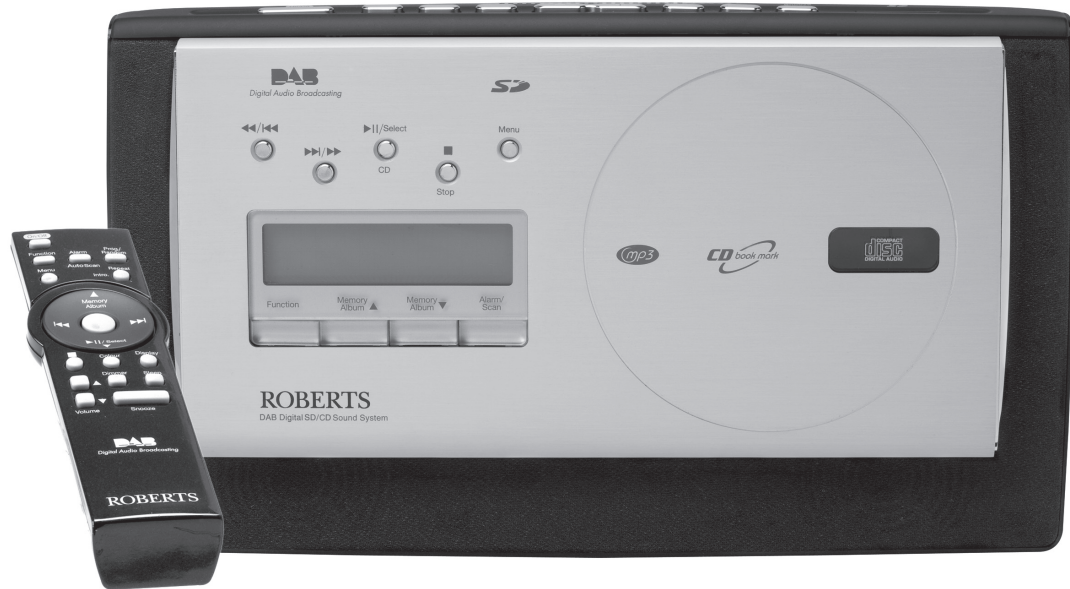

Please read this manual before use **DAB** Digital Audio Broadcasting

## Contents

<i>MP-24 System features</i> .....	2	<i>Sleep function</i> .....	32
<i>Controls</i> .....	3-6	<i>Snooze function</i> .....	33
<i>Remote handset battery replacement</i> .....	7	<i>Dimmer</i> .....	33
<i>Using your sound system for the first time</i> .....	8	<i>Auto-dimmer</i> .....	33
<i>Operating your radio - DAB</i> .....	9	<i>Backlight colour</i> .....	33
<i>Selecting a station - DAB</i> .....	10	<i>Clock display</i> .....	34
<i>Secondary services - DAB</i> .....	10	<i>Equaliser</i> .....	35-36
<i>Display modes - DAB</i> .....	11	<i>Ultra bass system</i> .....	36
<i>Finding new stations - DAB</i> .....	12	<i>Software version</i> .....	37
<i>Manual tuning - DAB</i> .....	13	<i>System reset</i> .....	37
<i>Signal strength display - DAB</i> .....	13	<i>Auxiliary In socket</i> .....	38
<i>Dynamic Range Control (DRC) settings - DAB only</i> .....	14	<i>Headphone socket</i> .....	38
<i>Operating your radio - Search tuning FM</i> .....	15	<i>Using an alternative aerial</i> .....	39
<i>Manual tuning - FM</i> .....	16	<i>General</i> .....	39
<i>Display modes - FM</i> .....	17	<i>Specifications</i> .....	40
<i>Presetting stations</i> .....	18-19	<i>Notes</i> .....	41
<i>Compact discs / MP3/WMA-CDs</i> .....	20-27	<i>Guarantee</i> .....	42
<i>Using SD cards</i> .....	28		
<i>Alarm</i> .....	29-31		

## MP-24 Sound system features

The Roberts MP-24 Sound system provides the following features in an attractive compact unit.

### Radio

The MP-24 can receive DAB and FM (with RDS) wavebands.

### CD

The MP-24 plays audio CDs (can also play CDR, CDRW discs.

### CD-MP3/WMA

The MP-24 plays MP3 and WMA files which have been recorded to CDR or CD-RW discs.

### SD slot

The MP-24 plays MP3 and WMA files from SD cards.

### Auxiliary input

The MP-24 can be used as an amplifier and loudspeaker system for external MP3 players, mini disc players and similar devices.

### Headphone output

A standard 3.5mm headphone socket is provided for private listening.

## Controls

(Top)

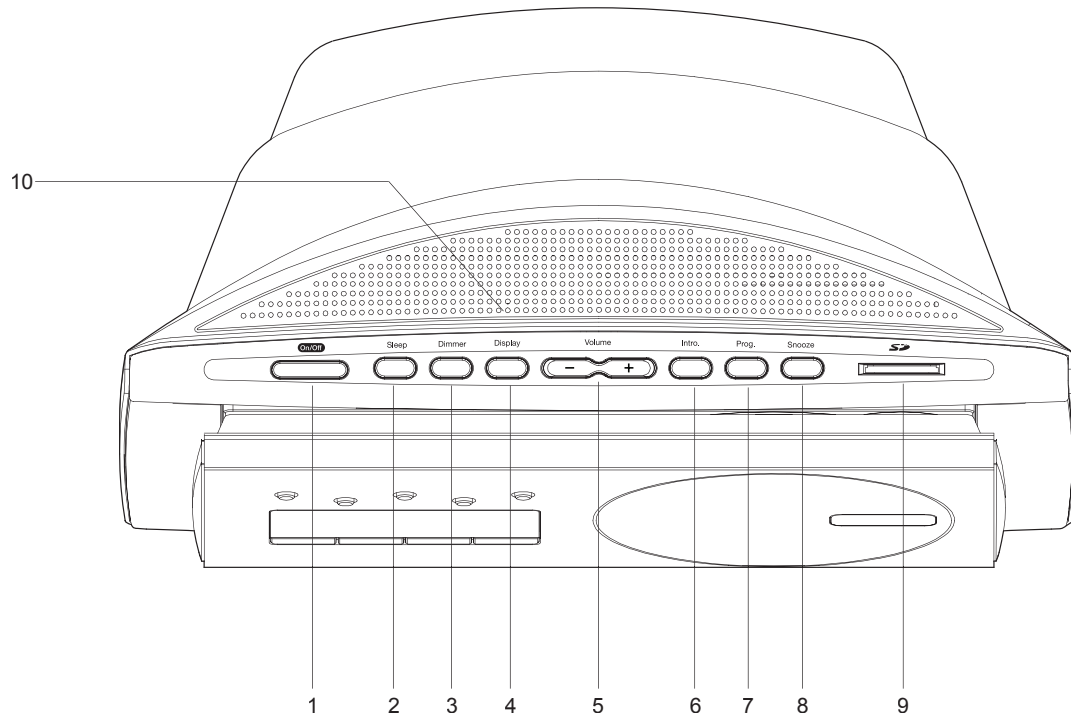

1. On/Off button
2. Sleep button
3. Dimmer button
4. Display button

5. Volume Up and Down button
6. Intro/Repeat button
7. Prog./Random button

8. Snooze button
9. SD card slot
10. Dimmer sensor

## Controls

### (Front)

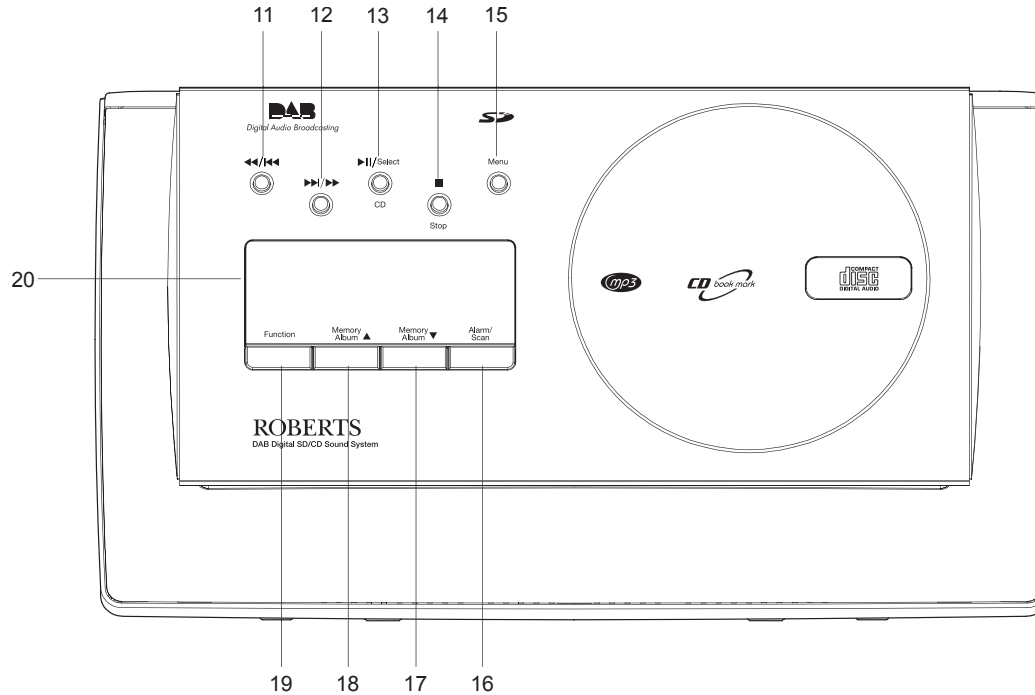

- 11. Skip Down/Rewind button
- 12. Skip Up/Fastforward button
- 13. Play/Pause/Select button
- 14. Stop button

- 15. Menu button
- 16. Alarm/Auto scan button
- 17. Mem/Album Down button
- 18. Mem/Album Up button

- 19. Function button
- 20. LCD display

If you need any further advice, please call our Technical Helpline on :-  
020 8758 0338 (Mon-Fri)

## Controls

(Left hand side)

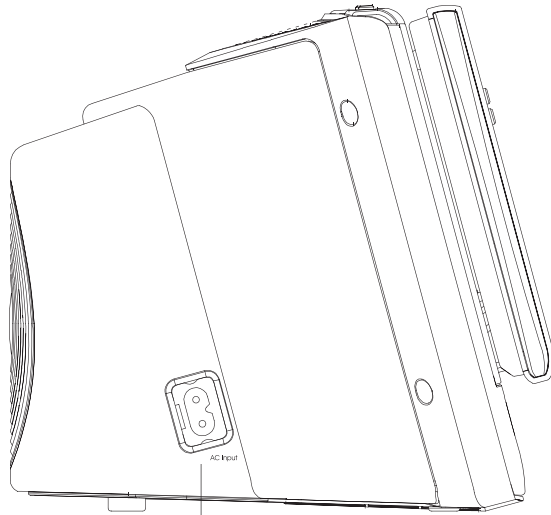

21

21. Mains input socket

(Right hand side)

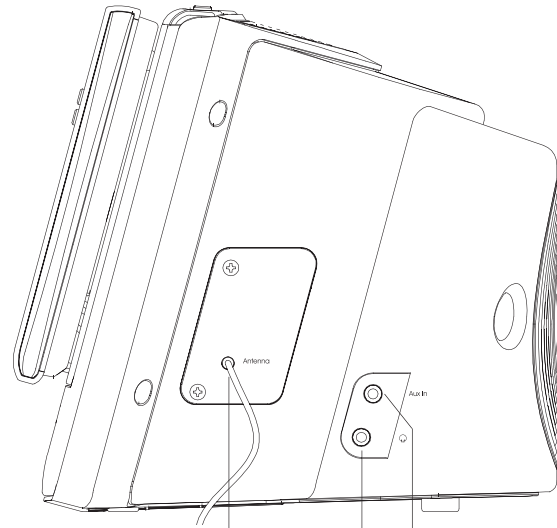

22

23

24

22. DAB wire antenna  
23. Headphone socket  
24. Auxiliary input socket

## Remote control

1. On/Off button
2. Function button
3. Menu button
4. Play/Pause/Select button
5. Skip Down/Rewind button
6. Sleep button
7. Volume Up button
8. Volume Down button
9. Snooze button
10. Dimmer button
11. Colour button
12. Stop button
13. Display button
14. Memory / Album Down button
15. Skip Up/Fastforward button
16. Memory / Album Up button
17. Intro / Repeat button
18. EQ / UBS button
19. Prog / Random button
20. Alarm / Autoscan button
21. Infra red emitter

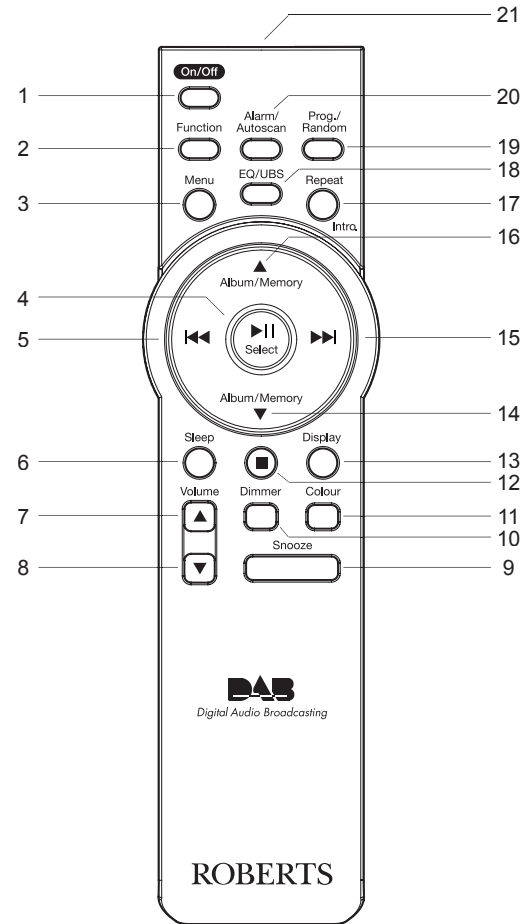

If you need any further advice, please call our Technical Helpline on :-  
020 8758 0338 (Mon-Fri)

## Remote handset battery replacement

1. Remove the battery cover on the rear of your remote control by applying pressure to the catch in the direction shown by the arrow in the diagram, and then lifting the cover.
2. Insert 2 x AAA size batteries into the compartment. Make sure the (+) and the (-) ends of the batteries are positioned as shown inside the compartment.
3. Close the battery cover by inserting the retaining lugs first, then apply pressure to the free end such that the catch latches the cover securely.
4. If the remote is not to be used for an extended period of time it is recommended that the batteries are removed.

**IMPORTANT:** *The batteries should not be exposed to excessive heat such as sunshine, fire or the like. After use, disposable batteries should if possible be taken to a suitable recycling centre. On no account should batteries be disposed of by incineration.*

1. Battery compartment
2. Latch
3. Retaining lugs (inside)

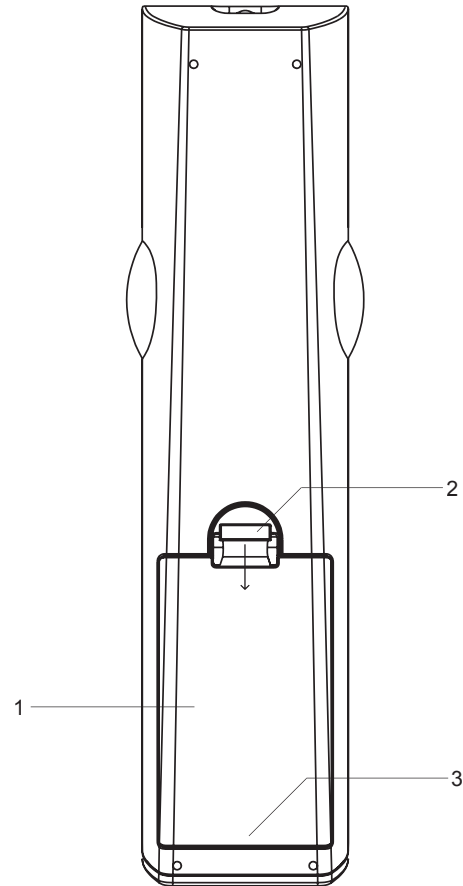



## Using the sound system for the first time

1. Place your sound system on a flat surface.
2. Fully extend the wire aerial located on the side of your sound system. The wire should be fully extended and positioned for optimum reception.
3. Plug the mains lead into the Mains socket located on the left hand side of your sound system ensuring that the plug is pushed fully into the socket.
4. Plug the other end of the mains lead into the wall socket and switch on the wall socket.

**IMPORTANT:** The mains plug is used as the means of connecting the sound system to the mains supply. The mains socket used for the sound system must remain accessible during normal use. In order to disconnect the sound system from the mains completely, the mains plug should be removed from the mains socket outlet completely.

5. When your sound system is first switched on the display will show "Setting Clock" and a station search will be performed automatically.
6. When stations have been found, the clock information will appear on the display. Press the **Display button** to toggle between showing the time only or showing both the date and time.
7. If no stations have been found "Clock not set" will be displayed. It may then be necessary to relocate your sound system to a position giving better reception. You should then carry out an autoscan to find stations as described on page 12.

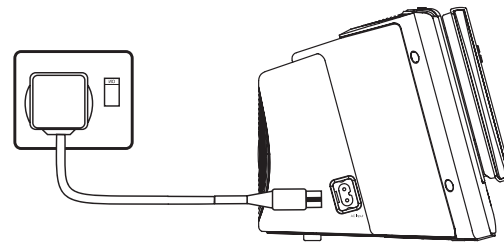

Setting Clock.

12:38

Clock not set.

## Operating your radio - DAB

1. Fully extend the wire aerial.
2. If your sound system is in standby mode, press the **On/Off button** [*On/off on the remote control*] to switch on your sound system.
3. Press and release the **Function button** to select DAB. The display will show "DAB" and then " Now tuning" for a few seconds.
4. If this is the first time the sound system is used a quick scan of UK Band III DAB channels may be carried out (the scan is normally performed automatically when the clock is first set - page 8). If the radio has been used before, the last used station will be selected. If new radio stations are found, they will be added to the stored list of stations.
5. When first switched on, the first station in the list of stations found will be played. The display will show the station name in the first line of the display and other information in the second line.
6. If the station list is still empty after the scan operation your radio will display "Station not available".
7. If no signals are found it may be necessary to relocate your radio to a position giving better reception, and then repeat the scan using the AutoScan facility (page 12).

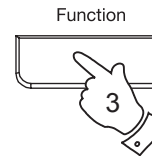
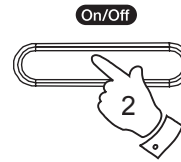

DAB

BBC 7  
Now tuning...

BBC 7  
Just a Minute...

Station not  
available

## Selecting a station - DAB

1. The top line of the display shows the name of the station currently selected.
2. Press the **Skip Up or Down buttons** to scroll through the list of available stations on the lower line of the display. Stop pressing the **Skip buttons** when you find the station that you wish to hear.
3. Press and release the **Select button** to select the station. The display may show "Now tuning" while your radio finds the new station.
4. Adjust the **Volume** to the required settings.

Note: If after selecting a station the display continues to show "Station not available" it may be necessary to relocate your radio to a position giving better reception.

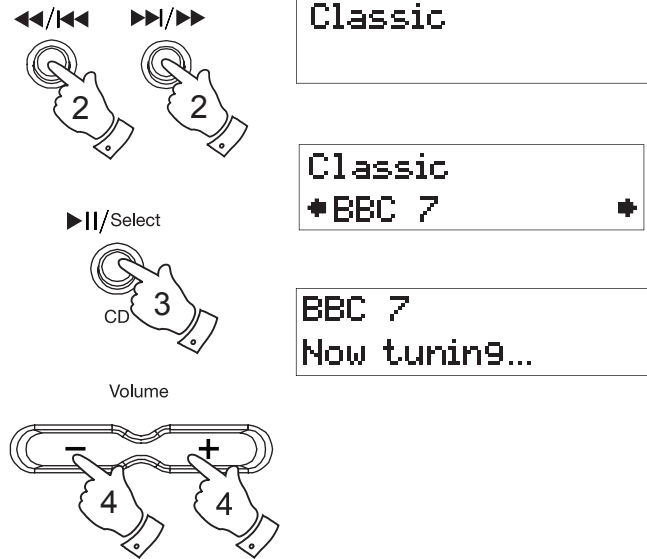

## Secondary services - DAB

1. Certain radio stations have one or more secondary services associated with them. If a station has a secondary service associated with it the display will show ">>" next to the station name on the station list. The secondary service will then appear immediately after the primary service as you press the **Skip Up button**.
2. Press and release the **Select button** to select the station.



If you need any further advice, please call our Technical Helpline on :-  
020 8758 0338 (Mon-Fri)

## Display modes - DAB

Your radio has seven display modes:-

1. Press the **Display button** to cycle through the various modes.

- |                        |   |
|------------------------|---|
| a. Scrolling text      | Displays scrolling text messages such as artist/track name, phone in number, etc.                               |
| b. Programme type      | Displays the programme type information for the station currently being received. e.g. Pop, Classic, News, etc. |
| c. Multiplex Name      | Displays the name of the DAB multiplex to which the current station belongs.                                    |
| d. Time and date       | Displays the current time and date.   |
| e. Channel & frequency | Displays channel number and frequency for the currently tuned DAB multiplex.                                    |
| f. Bit rate/audio type | Displays the digital bit rate and audio type.   |
| g. Signal error        | Displays signal error level for the station currently being received.   |

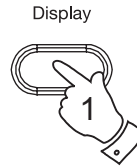

- |   |                           |
|---|---------------------------|
| a | BBC 7<br>Just a Minute... |
| b | BBC 7<br>Culture          |
| c | BBC 7<br>BBC National     |
| d | BBC 7<br>19:17 08-06-2006 |
| e | BBC 7<br>11C 220.35 MHz   |
| f | BBC 7<br>128kbps Stereo   |
| g | BBC 7<br>Signal error 0   |

## Finding new stations - DAB

As time passes new stations may become available. To find new stations proceed as follows:-

1. Press and release the **Alarm/Auto Scan button**. The display will show "Scanning". Your radio will perform a scan of the UK DAB frequencies. As new stations are found the station counter on the right-hand side of the display will increase and stations will be added to the list.
2. To carry out a full scan of the entire DAB Band III frequencies press and hold down the **Alarm/Auto Scan button** for more than 2 seconds and then release. The display will show "Scanning". As new stations are found the station counter on the right-hand side of the display will increase and stations will be added to the list.

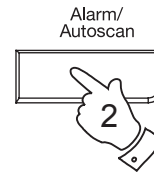
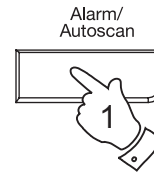

## Manual Tuning - DAB

Manual tuning allows you to tune directly to the various DAB Band III channels. UK DAB stations are located in the range 11B to 12D.

1. Press and release the **Menu button** until the display shows "Station order".
2. Press the **Skip Up or Down buttons** until "Manual tune" appears on the display. Press and release the **Select button**.
3. Press the **Skip Up or Down buttons** to select the required DAB channel.
4. Press and release the **Select button**. The clear unfilled rectangle in the indicator graph shows the minimum signal strength needed for good DAB reception. The bars will go up and down showing the changing signal strength as you adjust the wire aerial or your radio's position.
5. Press and release the **Select button** to return to normal tuning mode.

Menu

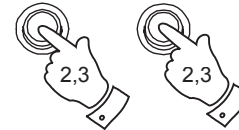
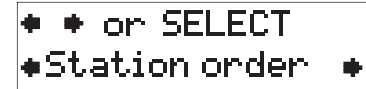

▶||/Select



## Signal strength display - DAB

1. Press and release the **Select button**. The lower line of the display shows signal strength. Position your radio and angle the wire aerial for best reception using the signal strength display as a guide. The strongest signal is indicated with the largest number of black rectangles on the signal strength display.
2. The clear unfilled rectangle indicates minimum signal level required for satisfactory reception. Press and release the **Select button** to return to the previous display mode.

▶||/Select



## Dynamic Range Control (DRC) settings - DAB only

Dynamic Range Control (also known as DRC) can make quieter sounds easier to hear when your radio is used in a noisy environment. This function is only available for the DAB waveband.

1. Press the **On/Off button** [On/off on remote control] to switch on your radio.
2. Press and release the **Menu button** until "Station order" appears on the display.
3. Press and release the **Skip Up and Down buttons** until the display shows "DRC value".
4. Press and release the **Select button** to enter adjustment mode. The top line of the display will show the currently applied DRC setting.
5. Press and release the **Skip Up or Down buttons** to select the required DRC setting (default is 0) .
  - DRC 0 DRC is switched off, Broadcast DRC will be ignored.
  - DRC 1/2 DRC level is set to 1/2 that sent by broadcaster.
  - DRC 1 DRC is set as sent by broadcaster.
6. Press and release the **Select button** to confirm the setting. The display will return to radio mode.

Note: Not all DAB broadcasts are able to use the DRC function. If the broadcast does not support DRC, then the DRC setting in the radio will have no effect,

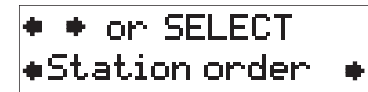
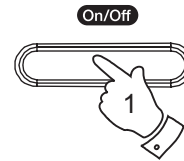

Menu



▶||/Select

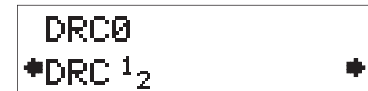

## Operating your radio - Search tuning FM

1. Fully extend the wire aerial and press the **On/Off button** to switch on your radio.
2. Press and release the **Function button** until the FM band is selected.
3. Press the **Skip Up button** and then press the **Alarm/Auto scan button**. Your radio will scan from the currently displayed frequency direction upwards and will stop scanning when it finds a station of sufficient strength.
4. The display will show the frequency of the signal which has been found. If RDS information is available, after a few seconds the display will show the radio station name. The display will also show "St" and "RDS" on the upper line if the station is received with stereo and RDS information.
5. To find other stations press and hold the **Alarm/Autoscan button** as above.
6. To scan the FM band in a downwards direction (high frequency to low frequency) press the **Skip Down button** and then press **Alarm/Auto scan button**.
7. When the end of the waveband is reached your radio will recommence tuning from the opposite end of the waveband.
8. Adjust the **Volume** to the required settings.
9. To switch off your radio press the **On/Off button**.

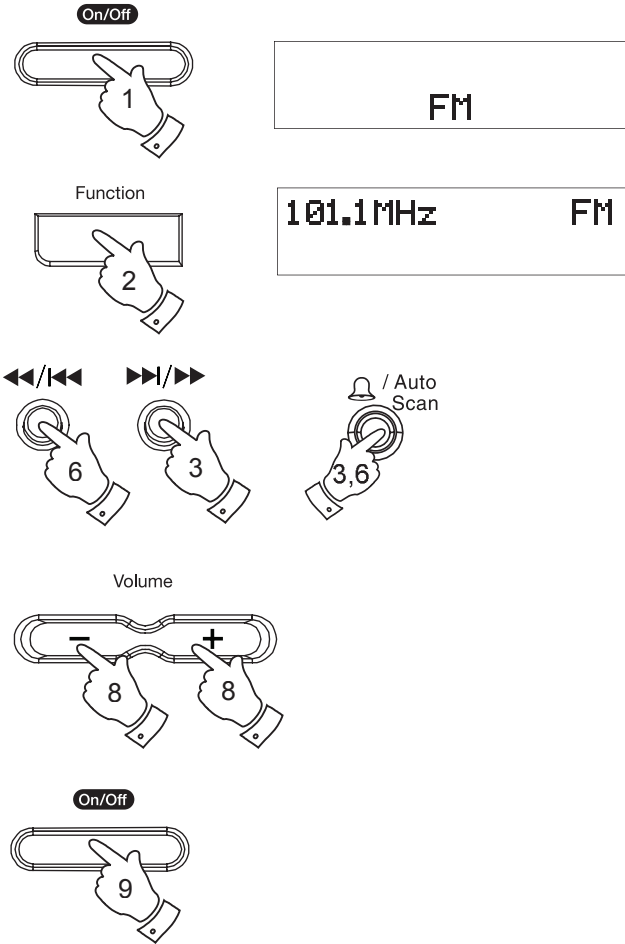



## Manual tuning - FM

1. Press the **On/Off button** to switch on your radio.
2. Press and release the **Function button** as needed to select the FM waveband.
3. Fully extend the **wire aerial** for FM reception.
4. Repeatedly press the **Skip Up and Down buttons** to tune to a station. The frequency will change in steps of 50kHz. Pressing and holding one of the buttons will advance the frequency selection several times each second.
5. When the end of the waveband is reached the radio will recommence tuning from the opposite end of the waveband.
6. Set the **Volume** to the desired settings.
7. To switch off your radio press the **On/Off button**.

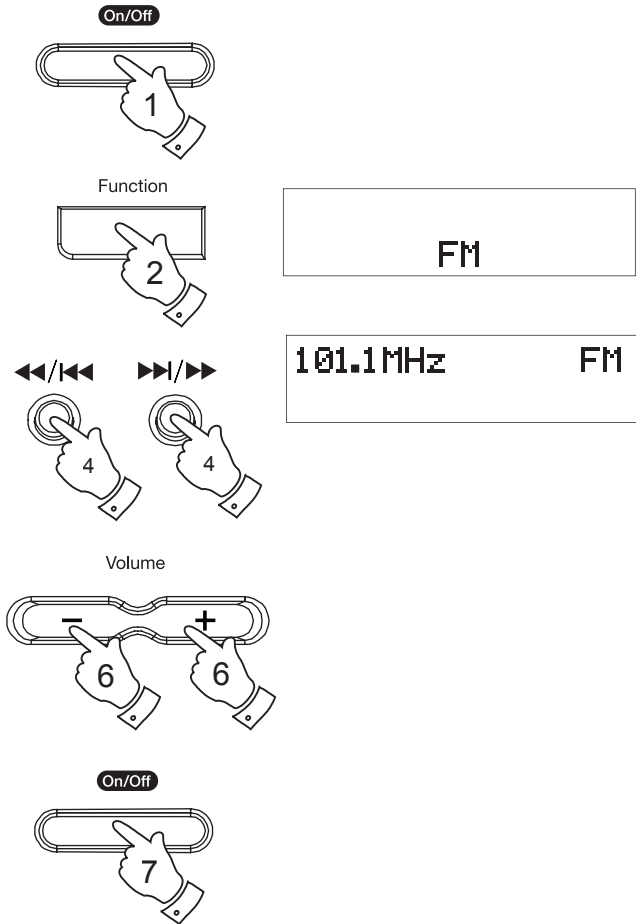

If you need any further advice, please call our Technical Helpline on :-  
020 8758 0338 (Mon-Fri)

## Display modes - FM

On FM the bottom line of the display can be set to any of the following modes:-

1. Press the **Display button** to cycle through the various modes.
  - a. Scrolling text Displays scrolling text messages such as artist/track name, phone in number etc.
  - b. Programme Type Displays programme type for the station currently being listened to e.g. Pop, Classic, News, etc.
  - c. Time and date Displays the current time and date.
  - d. Frequency Displays the frequency of the station being listened to.

Display



a  
Classic FM St.FM  
The latest news

b  
Classic FM St.FM  
Classical Music

c  
Classic FM St.FM  
12:02 16-06-2005

d  
Classic FM St.FM  
101.1MHz

## Presetting stations

There are 20 memory presets available. There are 10 on each of the DAB and FM wavebands.

1. Press the **On/Off button** to switch on your radio.
2. Tune to the required station as previously described.
3. Press the **Prog/Random button**, the display will show "Preset" with "01" flashing.
4. Use the **Memory Up or Down buttons** to select the desired preset number under which you wish to store the station.
5. Press the **Prog/Random button** again. The display will show, for example, "Preset 1 saving" and then "Preset 1 saved". The station will be stored under the chosen preset. Repeat this procedure for the other presets as needed.
6. Stations stored in preset memories may be overwritten by following the above procedure.

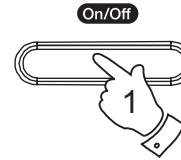

Prog.

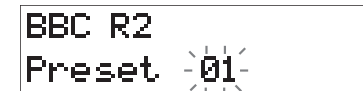
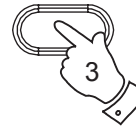

Memory Album ▲

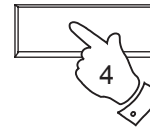

Memory Album ▼

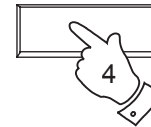

Prog.

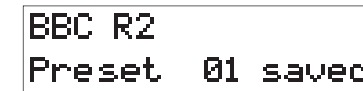
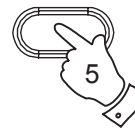

## Recalling a preset station

1. Press the **On/Off button** to switch on your radio.
2. Select the required waveband by pressing the **Function** button.
3. Press the **Memory Up or Down buttons** to select the desired preset number.
4. Your radio will tune to the station stored in preset memory.

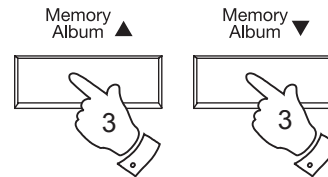
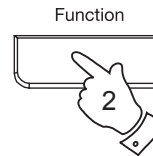
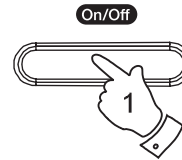

## Compact discs

Use only Digital Audio CDs which have the  symbol.

Never write on a CD or attach any sticker to the CD. Always hold the CD at the edge and store it in its box after use with the label facing up.

To remove dust and dirt, breathe on the CD and wipe it with a soft, lint free cloth in a straight line from the centre towards the edge.

Cleaning agents may damage the CD.

Do not expose the CD to rain, moisture, sand or to excessive heat. (e.g from heating equipment or in motor cars parked in the sun).

## CD-R/CD-RW discs

Your MP-24 can playback CDDA format audio CD-R/CD-RW discs that have been finalised\* upon completion of recording.

Your MP-24 may fail to playback some CD-R/CD-RW discs due to poor recording and wide variation in quality of the CD-R/CD-RW disc.

\*Finalising enables a CD-R/CD-RW disc to playback on audio players such as your MP-24.

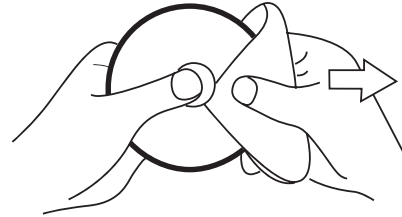

## WARNING

**CLASS 1 LASER PRODUCT** means that the laser's construction makes it inherently safe so that the legally prescribed maximum permissible radiation values can never be exceeded.

**Caution:** Using any equipment or devices other than those described and specified in these operating instructions, or tampering with the unit in any way, can result in dangerous exposure to radiation.

## MP3 / WMA CD Mode

The MP-24 is able to play CD-R and CD-RW discs containing MP3 or WMA files.

In MP3/WMA mode the terms "album" and "file" are very important. "Album" corresponds to a folder on a PC, "File" to an audio track in MP3 or WMA format. The radio reads MP3 or WMA files with a maximum of 255 files per folder. An MP3 or WMA CD may not contain more than 512 files or albums in total. MP3 or WMA files must be created with an audio sample rate of 44.1kHz (this is normal for files created from CD audio content). Both MP3 and WMA files may be recorded on to the same media.

When burning CD-R and CD-RWs with audio files, various problems may arise which could lead to interference in playback. This can be caused by faulty software or hardware settings in your PC or by the CD being used. Should such problems arise, contact the customer services of your CD burner or software manufacturer or look for relevant information, for example on the internet. When you are making audio CDs, observe all legal guidelines and ensure that the copyright of third parties is not infringed.



**CLASS 1  
LASER PRODUCT**

## Inserting a CD

1. To open the CD compartment, tilt the front panel forwards.
2. Put the CD on the spindle until it clicks into place and then gently close the CD compartment by moving the front panel to its original position.

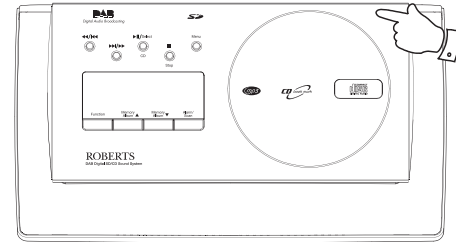

## Playing a CD

1. Press the **On/Off button** to switch on your sound system.
2. Press the **Function button** to choose CD as the input source.

The CD player will scan the contents of the CD and "READING" will appear on the display.

Audio CD: the total number of tracks and total playing time will then be displayed.

MP3 / WMA CD: The total number of files and folders then be displayed.

3. Press the **Play/Pause Select button** to start playback. The display will show the first track number and the play symbol ►. The radio will also show:

Audio CD: The current track number and elapsed playing time.

MP3/WMA CD: The current file number for 3 seconds, before changing to show the file name, ID3 tag and the elapsed playing time.

4. Adjust the **Volume** to the required settings.

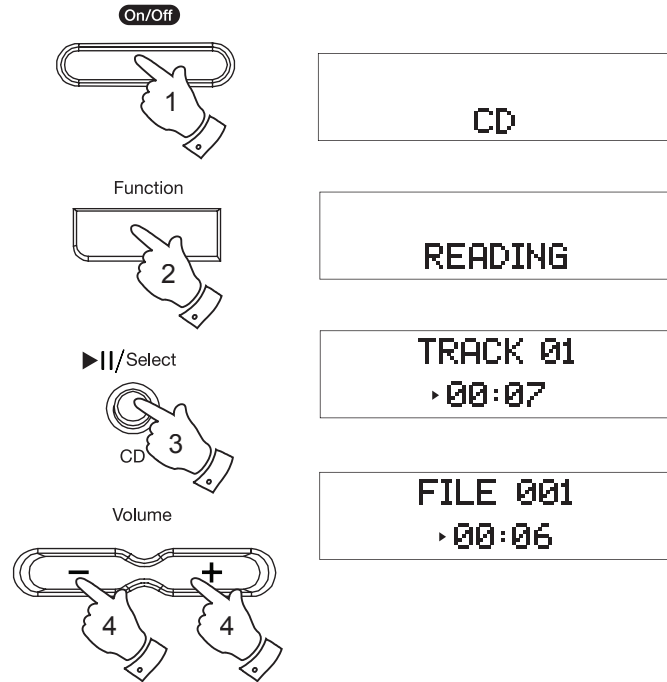

If you need any further advice, please call our Technical Helpline on :-  
020 8758 0338 (Mon-Fri)

- To pause playback press the **Play/Pause/Select button**. The pause symbol **||** will flash on the display.

Audio CD: The current track number and the elapsed playing time will be shown on the display.

MP3 / WMA CD: The file name with ID3 tag scrolls, the elapsed playing time will be shown on the display.

- To continue playback press the **Play/Pause/Select button** again.
- To stop playback, press the **Stop button** once. The display will then show:  
Audio CD: The current track number and "Resume".  
MP3 / WMA CD: The file number and "Resume".

Note: The Resume feature means that even if you put the radio into Standby mode or change the radio function, the next CD play operation will start from the the point where playback was previously stopped. If mains power is removed and restored the resume setting will be cancelled and the CD will play from the beginning.

- If you wish to cancel the Resume function, you can press the **Stop button** a second time or take out the CD.
- To take out the CD, open the CD door on the unit by tilting the front panel forwards. The CD door should only be opened when the CD player is in stop mode.

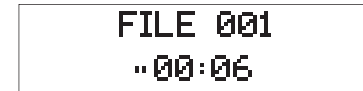
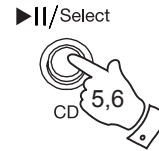



## Selecting a track

1. Audio CD: While the CD is playing, press either the **Skip Up or Down buttons** to change the desired track. You can also skip to a wanted track when the player is in stop mode. Press the **Play/Pause/Select button** to play the selected track.
2. MP3 / WMA CD: While the CD is playing, press either the **Memory/Album Up or Down buttons** to change to the desired album / folder, then press either the **Skip Up or Down buttons** to change to the desired track. You can also skip albums or tracks when the player is in stop mode. Press the **Play/Pause/Select button** to play the selected track.

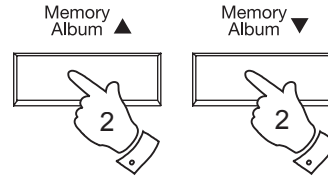
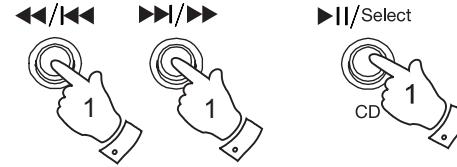

## Search function

1. While the CD is playing, press and hold down either the **Skip Up or Down button**. Release the button when the desired part of the track is reached.

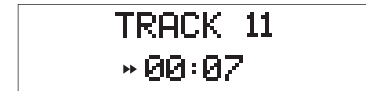
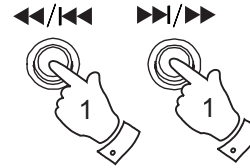

## CD repeat mode

1. Whilst the CD is playing press the **Intro/Repeat button**. The radio will step through the following options:

Audio CD: Repeat 1  → Repeat ALL  , → Normal Play

MP3 / WMA CD: Repeat 1  , → Repeat Album  , → Repeat ALL  , → Normal Play

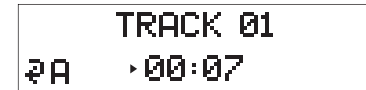
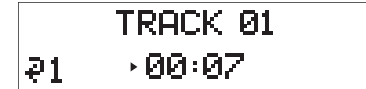
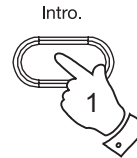

2. The display will show the currently selected repeat mode.

## CD Intro mode

1. When in the stop mode, press the **Intro/Repeat button** once to play the first 10 seconds of each of the tracks on the disc. "Intro" appears on the display.
2. To cancel the Intro mode, press the **Intro/Repeat button**.

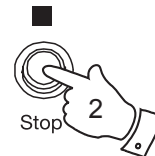
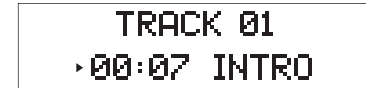

## CD Random play

1. While the CD is playing, press the **Prog/Random button** to play all tracks on the CD in random order. "RAND" will appear on the display. The tracks are played in random order until all tracks have been played.
2. Press the **Prog/Random button** again to return to normal play. "RAND" will disappear from the display.

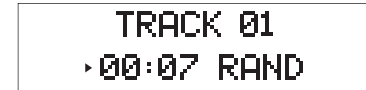

## Creating a play list (Program Play - audio CD only)

By programming the player you can play up to 20 tracks in any desired order.

1. Whilst the CD is in Stop mode, press the **Prog/Random button**. The display will show "P-01".  
Audio CD: Select the first track using the **Skip Up or Down buttons**. "PROG" will flash on the display. Store this track by pressing the **Prog/Random button**.
2. Repeat the above steps until you have completed your program.
3. Press the **Play/Pause/Select button** to commence play of selected tracks.

**Note:** Programme play is available on original Audio CDs, and CDDA audio on CD-R or CD-RW discs only. MP3 / WMA playback cannot be programmed.

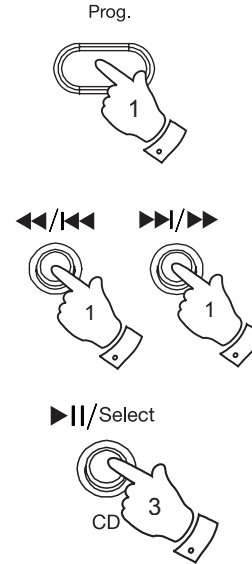

## Checking and Editing a programme

Whilst the CD is in stop mode, you can check and edit the program.

1. Press the **Prog/Random button** repeatedly. The display will show the play list that you have already programmed.
2. You can edit the playlist. When the desired track that you want to edit is reached, follow the procedure for creating a playlist page 26.



## Erasing a programme

1. Press the **Stop button** when in programme mode to erase the programme. Programmes are also erased by putting the radio into to standby, radio, SD or Aux-in mode.

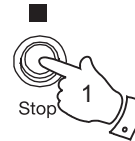

## Using SD cards

Secure Digital (SD) cards can be used with the MP-24 for playback of MP3 or WMA files.

Many different brands and capacities of SD card are available. Your MP-24 has been tested with a range of card types up to 2 GB capacity. However, there are many different card variants available and not all cards can be guaranteed to work in the MP-24. The new High Capacity (SDHC) card type is not compatible with the MP-24.

SD card slot is located at the right-hand end of the top edge of the unit.

### Inserting and removing a card

To insert an SD card into your radio push the card **label side forwards and gold contacts first** into the SD card slot on the top of your radio until it clicks.

To remove the card push the card in slightly and it will pop out allowing removal.

1. To select SD card mode press the **Function button**.

Playback control in SD card mode is similar to CD-MP3/WMA mode (see page 22).

MP3 or WMA files are played back in the order that they are written to the SD card by your computer, except when Random mode is used.

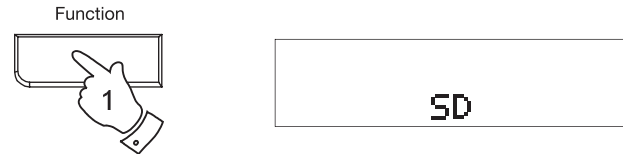
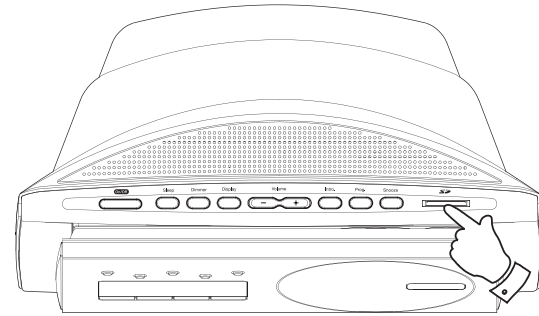

## Alarm mode

Your sound system has four alarms which can be set to wake you by radio (FM or DAB), CD, SD or beep type alarm. Each alarm can be set to sound:

- Once only
- Everyday
- Monday to Friday
- Monday to Saturday
- Saturday to Sunday

The alarms can only be set with the radio in standby mode. In the event of a power failure the alarm settings will be retained for up to 24 hours.

Note: If no buttons are pressed for 10 seconds, the radio will exit the alarm setup. To exit the alarm menu at any time press the Menu button.

1. Press and hold the **Alarm button** for 3 seconds. "Alarm" appears with "1" flashing on the display.
2. Press the **Skip Up or Down buttons** to select between Alarm 1 to 4.
3. Press the **Alarm button** to enter the Alarm setup.
4. The hours digits will flash on the display. Press the **Skip Up or Down buttons** to select the desired alarm hour, then press the **Alarm button** to confirm the setting.
5. The minute digits will flash on the display. Press the **Skip Up or Down buttons** to select the desired alarm minute.

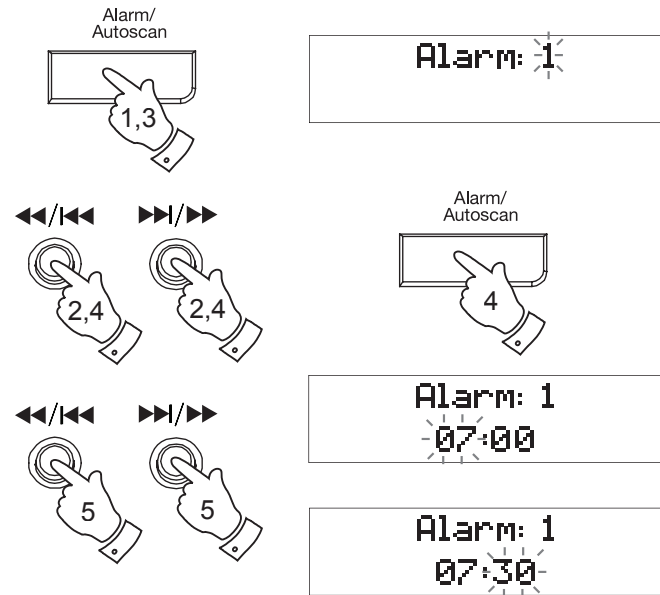

- Press the **Alarm button** to confirm the setting and to enter the alarm day option menu. You can select between once, daily, Mon-Fri, Mon-Sat and Sat-Sun.

	Display	
Once	(Once)	- Will sound at one time only
Mon-Sun	(Daily)	- Will sound every day
Mon-Fri	(1-5)	- Will sound every weekday
Mon-Sat	(1-6)	- Will sound from Monday to Saturday
Sat-Sun	(6-7)	- Will sound only on weekends

- Press the **Skip Up or Down buttons** to select the desired Alarm day option.
- Press the **Alarm button** to confirm the alarm day setting and to enter the alarm mode selection menu.
- Press the **Skip Up or Down buttons** to select the desired alarm mode. You can choose between OFF, BUZZER, DAB, CD, SD and FM. Then press the **Alarm button** to confirm the setting. When the alarm mode is set to "OFF" the alarm will be disabled.
- Press the **Skip Up or Down buttons** to adjust the alarm volume. Then press the **Alarm button** to confirm the setting.
- Then "Snooze 5 minutes" will be shown on the display. Press the **Skip Up or Down buttons** to select the desired snooze timer from 5, 10, 15 and 20 minutes. Then press the **Alarm button** to confirm the setting.

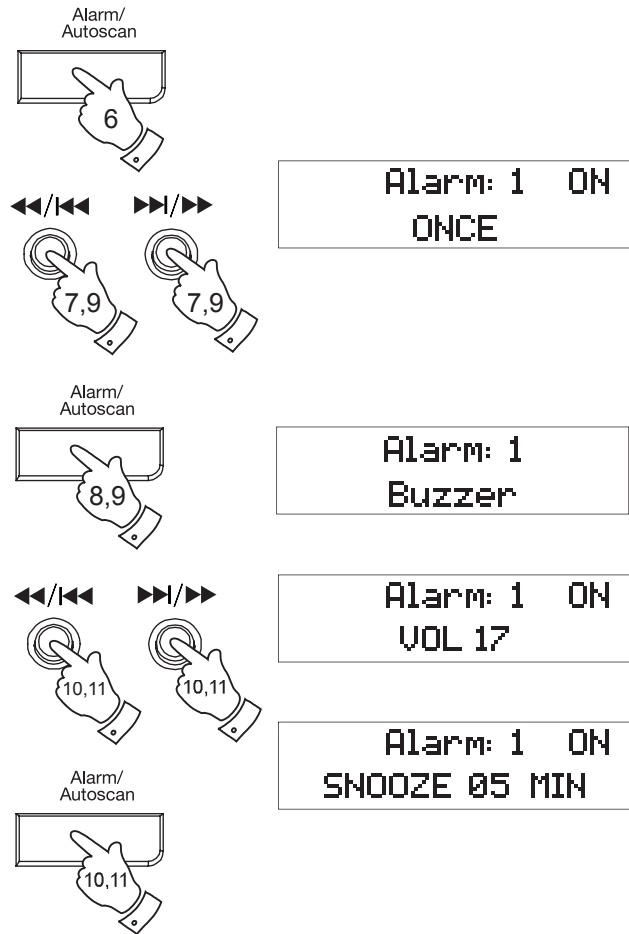

12. When the radio display is set to show both time and date the alarm symbol will appear if an alarm is set. To toggle between the large time display and the time and date display press the **Display button**.

Note: When the alarm is set to wake by radio, the last used station will be switched on at the alarm time.

When the alarm activates, the volume will start from minimum and increase in level every 2-3 seconds. The alarm will sound for 90 minutes unless cancelled.

Make sure that a CD has been inserted when choosing CD as the alarm mode. If a CD is not present at the alarm time, the buzzer alarm will be used instead.

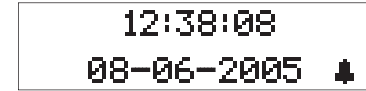
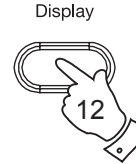

### View the alarm time

1. Repeatedly press the **Alarm button** to view the time settings for Alarm 1 to Alarm 4.

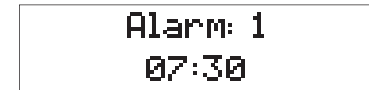
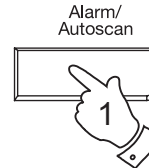

### To cancel the alarm

1. While an alarm is sounding it can be cancelled for 24 hours by pressing the **On/Off button**.
2. To permanently cancel an alarm, enter the alarm setup menu for the alarm that you wish to cancel, and set the alarm mode to the "OFF" option (see step 9 on the preceding page).

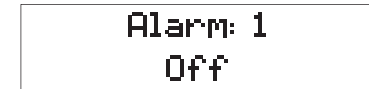
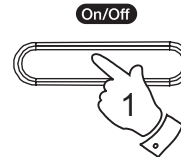



## Sleep function

Your sound system can be set to turn off after a preset time has elapsed. The sleep setting can be adjusted between 0 and 90 minutes in 10 minute increments.

1. To set the desired sleep time, press the **Sleep button** to enter the sleep setup. "Sleep 90" will be displayed.
2. Repeatedly press the **Sleep button** to adjust the sleep countdown timer to the desired duration, ranging from 0-90 minutes in 10 minute increments. The sleep timer will be set to the displayed time.  
If the radio is in standby mode when the Sleep button is first pressed then it will be switched on for the selected time. If the radio is already on, then it will simply switch off after the selected time.
3. During the sleep timer countdown period, press the **Sleep button** to view the remaining time as needed or to change the sleep timer setting.
4. Your radio will switch off after the preset sleep time has elapsed.
5. To cancel the sleep function and switch off the radio before the preset time has elapsed, press the **On/Off button** or the **Snooze button**.  
To cancel the sleep timer and leave the radio switched on, repeatedly press and release the **Sleep button** to set the sleep timer to 0 minutes.

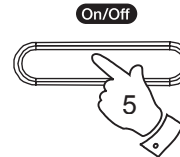

## Snooze

1. When the alarm sounds, pressing the **Snooze button** will silence the alarm for the number of minutes specified for that particular alarm.
2. The snooze setting can be adjusted between 5, 10, 15 and 20 minutes in 5 minute increments in the Alarm settings (see pages 29-31).

Snooze

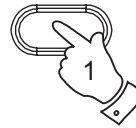

## Dimmer

1. Press the **Dimmer button** to change the backlight illumination level between high, low and off settings. This setting sets a maximum brightness level for the auto-dimmer.

Dimmer

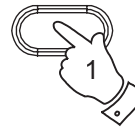

## Auto-Dimmer

1. The auto-dimmer located on the top of your sound system will automatically adapt the intensity of the display lighting to compensate for changes in the ambient light level.

## Backlight colour

1. Press the **Colour button** on the remote control to change the backlight illumination colour according to your personal preference. There are 8 colours from which to choose. The colour can be changed whether the radio is switched on or is in standby mode.

## Clock display

When in Standby your sound system has two display modes, time or time and date combined.

1. If your sound system is switched on, press the **On/Off button** to switch your sound system to the standby mode.
2. To toggle between the two display modes press the **Display button**.

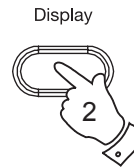
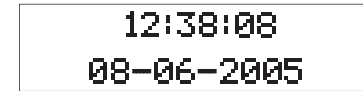
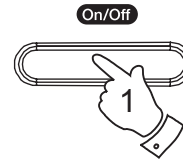

## Equaliser

The tone on your sound system can be adjusted to suit the particular broadcast listened to. Your radio has four equaliser modes.

1. Press the **EQ/UBS button** (on the remote control) to cycle through the various modes: Rock, Pop, Jazz, Classic and User.
2. The first press displays the current mode. Subsequent presses cycle through each mode. The selected mode remains active after the display times out. (after 5 seconds).

### User settings for the equaliser

The User mode for the equaliser allows you to adjust the bass and treble setting to your own personal preference.

1. Press the **EQ/UBS button** (on the remote control) until the screen displays "EQ User".
2. Then immediately press and hold the **EQ/UBS button** for 2 seconds to enter bass and treble level control. "User Bass 0" will be displayed, the default Bass level is 0.
3. Press the **Skip Up or Down buttons** to adjust the required level between +/-5.

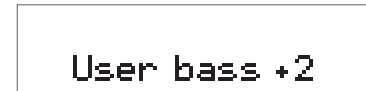
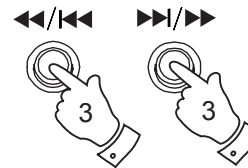
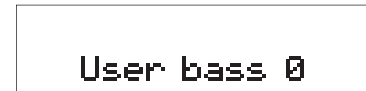
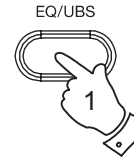
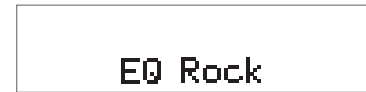
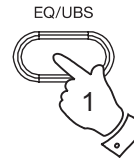

4. Press the **EQ/UBS button** again and "User Treble 0" will be displayed. The default Treble level is 0.
5. Press the **Skip Up or Down buttons** to adjust the required Treble level between +/-5.

Note: If no button is pressed within 5 seconds the equaliser menu will exit and your changes will be accepted.

### Ultra Bass System (UBS)

1. You can activate and deactivate the UBS (Ultra bass system) by pressing and holding the **EQ/UBS button** until the display shows "UBS On" or "UBS Off".
2. The first press shows the current setting. Subsequent presses alternate between UBS On and UBS Off. After 5 seconds the display will revert to the prior display mode.

Note: The unit cannot access this feature while one of the EQ modes is displayed. If you have just set an EQ mode, please wait for the display to cancel first before attempting to control the UBS function.

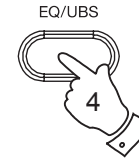

User treble 0

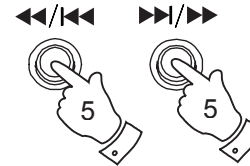

User treble +3

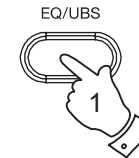

UBS Off

UBS On

## Software version

The software display cannot be altered and is just for your reference.

1. To view which software version your sound system has ensure your sound system is in DAB mode and press the **Menu button** to enter the menu setup.
2. Press the **Skip Up or Down buttons** until "SW Version" together with the Version number appears on the display.

Menu



◆ U1.35.3.1-3  
◆ SW Version ◆

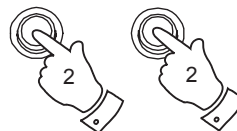

## System Reset

If your radio fails to operate correctly, or some digits on the display are missing or incomplete, carry out the following procedure.

1. While in DAB or FM mode press and hold the **Menu button** until the display shows "Press SELECT to confirm reset".
2. Press and release the **Select button** to select system reset.

Menu



Press SELECT to  
confirm reset...

A full reset will be performed and the station list together with any preset stations will be erased.

In case of malfunction for any reason, just reset the product to resume normal operation. It may be necessary in some cases to disconnect the mains power and then reconnect after 10 seconds.

In case of malfunction due to electrical fast transient (Burst), just reset the product (reconnect of power source may be required) to resume normal operation.

▶||/Select



## Aux in socket (3.5mm Jack)

1. Repeatedly press and release the Function button until "Aux" is selected.
2. Connect a stereo or mono audio source (ie iPod, MP3 or CD player) to the Aux in socket on the right-hand side of the radio.
3. Adjust the Volume control on your iPod, MP3 or CD player for comfortable listening.

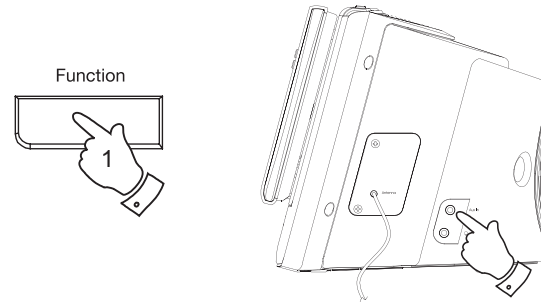

## Headphone socket

1. A 3.5mm **Headphone Socket** is provided on the right-hand side of your radio for use with headphones to permit private listening. Inserting a plug automatically mutes the internal loudspeakers.
2. Adjust the volume on the radio as needed.  
Please be aware that the sensitivity of headphones can vary widely. We therefore recommend setting volume to a low level before connecting headphones to the radio.

**IMPORTANT:** Excessive sound pressure from earphones and headphones can cause hearing loss.

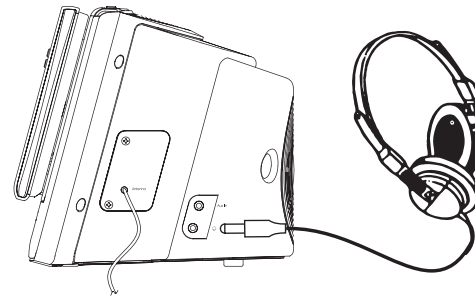

*If you need any further advice, please call our Technical Helpline on :-  
020 8758 0338 (Mon-Fri)*

## Using an alternative aerial

Your sound system comes with a wire aerial which should be arranged vertically behind the unit for best DAB reception. With reasonable signal conditions this will be sufficient for good reception. However, if the signal at the chosen location for the radio is very poor, it may be that reception would benefit from an external aerial.

1. To remove the supplied aerial, first disconnect the unit from the mains.
2. Then remove the small cover panel on the right hand side of the unit. This is secured with two screws.
3. A special aerial removal tool is supplied with your sound system. Pass the wire of the aerial through the tool, and then insert the tool into the recess beneath the cover.
4. Turn the tool anti-clockwise to disconnect the aerial. This reveals a standard F-type socket on to which an alternative aerial feed may be connected.
5. Reverse the procedure if you wish to re-attach the supplied aerial.

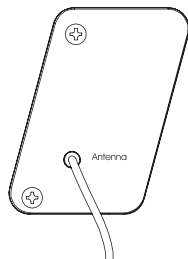

## IMPORTANT:

- The mains plug is used as the means of connecting the sound system to the mains supply. The mains socket used for the sound system must remain accessible during normal use. In order to disconnect the sound system from the mains completely, the mains plug should be removed from the mains socket outlet completely.
- The sound system shall not be exposed to dripping or splashing and that no objects filled with liquids, such as vases, shall be placed on the radio.
- It is recommended to operate the product such that there is a minimum distance (10cm recommended) to adjacent objects in order to ensure good ventilation.
- The ventilation of the product should not be restricted by covering it or its ventilation openings with items such as newspapers, table-cloths, curtains etc.
- No naked flame sources such as lighted candles should be placed on the product.
- It is recommended to avoid using or storing the product at extremes of temperature. Avoid leaving the unit in cars, on window sills in direct sunlight etc.
- The sound system must be used in a moderate climate.

## General

Do not allow this radio to be exposed to water, steam or sand. Do not leave your radio where excessive heat could cause damage. It is recommended that the DAB band be used wherever possible as better results in terms of quality and freedom from interference will usually be obtained than on the FM band.

- The name plate is located on the underside of your sound system.





## Specifications

### Power Requirements

Mains	AC 230 volts, 50Hz $\sim$ only
Battery (Remote control)	2 x AAA

### Frequency Coverage

FM	87.5-108MHz
DAB	174.928 - 239.200MHz

## Circuit features

### Loudspeakers

Tweeters	2 x 34 mm, 4 ohms, 2 x 3W
Woofers	1 x 76 mm, 6 ohms, 6W

### Headphone socket

3.5mm dia

### Auxiliary in socket

3.5mm dia

### Aerial System

FM	Wire aerial
DAB	Wire aerial

The Company reserves the right to amend the specification without notice.



## Guarantee

This instrument is guaranteed for twelve months from the date of delivery to the original owner against failure due to faulty workmanship or component breakdown, subject to the procedure stated below. Should any component or part fail during this guarantee period it will be repaired or replaced free of charge.

The guarantee does not cover:

1. Damage resulting from incorrect use.
2. Consequential damage.
3. Receivers with removed or defaced serial numbers.

Procedure:

Any claim under this guarantee should be made through the dealer from whom the instrument was purchased. It is likely that your Roberts' dealer will be able to attend to any defect quickly and efficiently but should it be necessary the dealer will return the instrument to the Company's service department for attention. In the event that it is not possible to return the instrument to the Roberts' dealer from whom it was purchased, please contact Roberts Radio Technical Services at the address shown overleaf.

These statements do not affect the statutory rights of a consumer.



*Issue 1*

## **ROBERTS RADIO TECHNICAL SERVICES**

97-99 Worton Road

Isleworth Middlesex

TW7 6EG

Technical Helpline :- 020 8758 0338 (Mon-Fri during office hours)

Website: <http://www.robertsradio.co.uk>

