

ROBERTS

duologic

Stereo DAB / DAB+ / FM RDS digital portable radio



DAB
Digital Audio Broadcasting

DAB+

+ Digital
Radio

Please read this manual before use

Contents

<i>Controls</i>	2-3	<i>Stereo / mono setting - FM</i>	20
<i>Battery operation using alkaline batteries</i>	4	<i>Software version</i>	20
<i>Battery operation using rechargeable batteries</i>	5	<i>System reset</i>	21
<i>Using the AC adaptor</i>	6	<i>Headphone socket</i>	22
<i>Operating your radio - DAB</i>	7	<i>Auxiliary input socket</i>	22
<i>Selecting a station - DAB</i>	8	<i>A few words about batteries</i>	23-24
<i>Display options - DAB</i>	9	<i>Display backlight</i>	25
<i>Finding new stations - DAB</i>	10	<i>General</i>	26
<i>Secondary services - DAB</i>	10	<i>Specifications</i>	26
<i>Manual tuning - DAB</i>	11	<i>Circuit features</i>	26
<i>Signal strength display - DAB</i>	11	<i>Guarantee</i>	Back page
<i>Dynamic range control (DRC) settings - DAB</i>	12		
<i>Prune stations - DAB</i>	13		
<i>Operating your radio - Search tuning - FM</i>	14		
<i>Manual tuning - FM</i>	15		
<i>Display options - FM</i>	16		
<i>Favourite button</i>	17		
<i>Recalling your favourite station</i>	17		
<i>Preset stations - DAB and FM</i>	18		
<i>Scan sensitivity - FM</i>	19		

Controls

(Front)

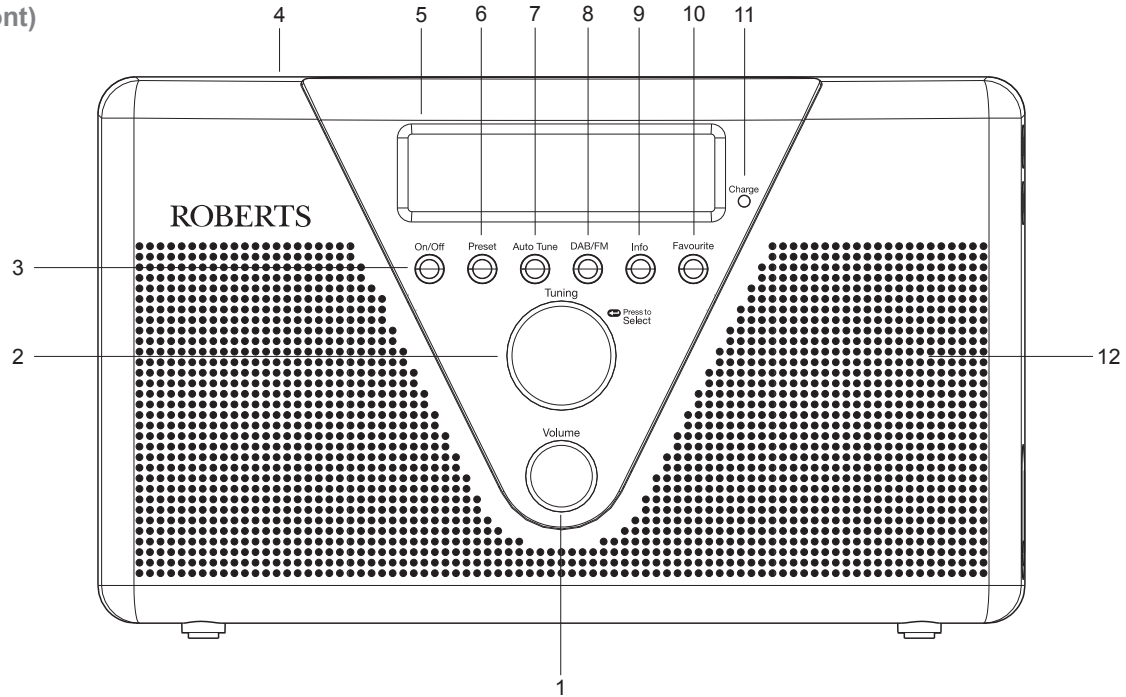

1. Volume control
2. Tuning control
3. On / Off button
4. Telescopic aerial

5. LCD display
6. Preset button
7. Auto Tune button
8. DAB / FM button

9. Info button
10. Favourite button
11. Charge indicator
12. Speaker x 2

Controls

- 13. Headphone socket
- 14. Auxiliary input socket
- 15. Battery compartment
- 16. USB socket (for software upgrades)
- 17. DC input socket

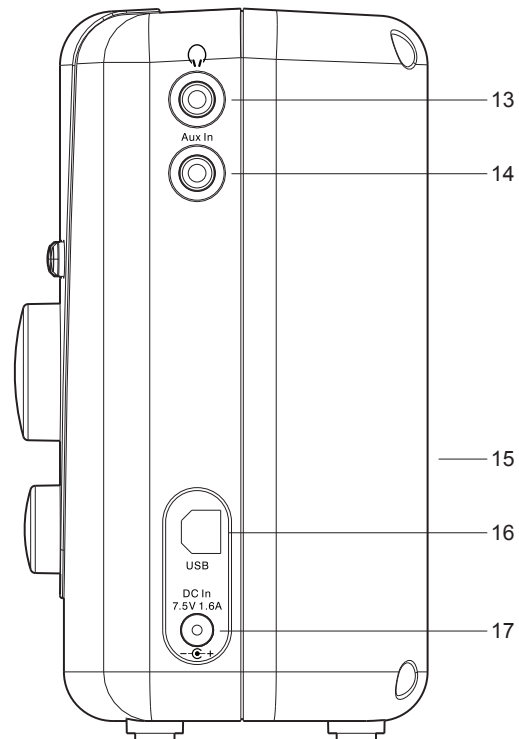

Battery operation using alkaline batteries (also see page 23)

1. Remove the battery cover on the back of the unit by pushing the battery door in slightly and then downwards in the direction of the arrows in the diagram.
2. Slide the switch inside the battery compartment to the **Alkaline** position.
3. Insert four LR20 (D size) alkaline batteries into the spaces in the compartment. Take care to ensure all batteries are inserted with the correct polarity as shown on the back of the radio. Then replace the battery cover.

- **Important: when using alkaline batteries the battery switch must be placed in the alkaline position. Failure to do so could result in serious damage to the batteries or radio.**
- When the batteries are exhausted, the charge indicator light will show red for a short while. The radio will then switch itself off. It may not be possible to switch the radio back on until the batteries are replaced, or until the radio is connected to the mains adaptor.
- If the radio is not to be used for any extended period of time it is recommended that the batteries are removed from the radio.
- *We would recommend for economy that the **duologic** is used via the AC adaptor whenever possible with battery operation for occasional or stand-by use only. If extended listening using batteries is anticipated, then the use of rechargeable batteries is recommended.*

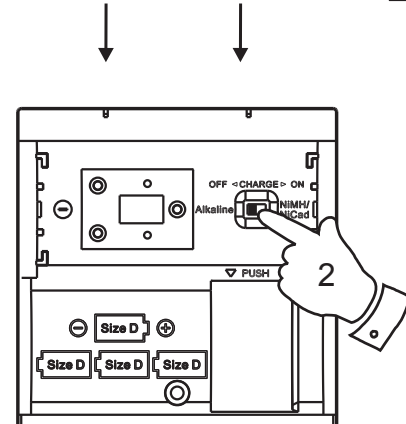
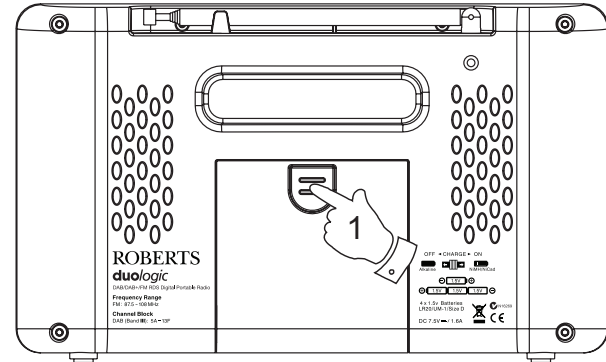

Battery operation using rechargeable batteries (also see page 23)

1. Remove the battery cover on the back of the unit by pushing the battery door in slightly and then downwards in the direction of the arrows in the diagram.
 2. Slide the switch inside the battery compartment to the **NiMH/NiCad** position.
 3. Insert four Rechargeable LR20 (D size) batteries into the spaces in the compartment. Take care to ensure all batteries are inserted with the correct polarity as shown on the back of the radio. The radio is designed to be used with Nickel Metal Hydride (NiMH) or Nickel Cadmium (NiCad) rechargeable batteries.
 4. Plug the mains adaptor into your radio and then plug the adaptor into the mains.
 5. The Charge light will flash green indicating batteries are charging. Batteries will be fully charged in around 7 hours. The charge light shows a steady green light when the battery charging is complete.
- **Important: when using rechargeable batteries the battery switch must be placed in the NiMH/NiCad position. Batteries will only be charged when the radio is switched off and connected to the AC adaptor.**
 - When the batteries are exhausted, the charge indicator light will show red for a short while. The radio will then switch itself off. It may not be possible to switch the radio back on until the batteries are recharged, or until the radio is connected to the mains adaptor.
 - If the radio is not to be used for any extended period of time it is recommended that the batteries are removed from the radio.

IMPORTANT: The batteries should not be exposed to excessive heat such as sunshine, fire or the like. After use, disposable batteries should if possible be taken to a suitable recycling centre. On no account should batteries be disposed of by incineration.

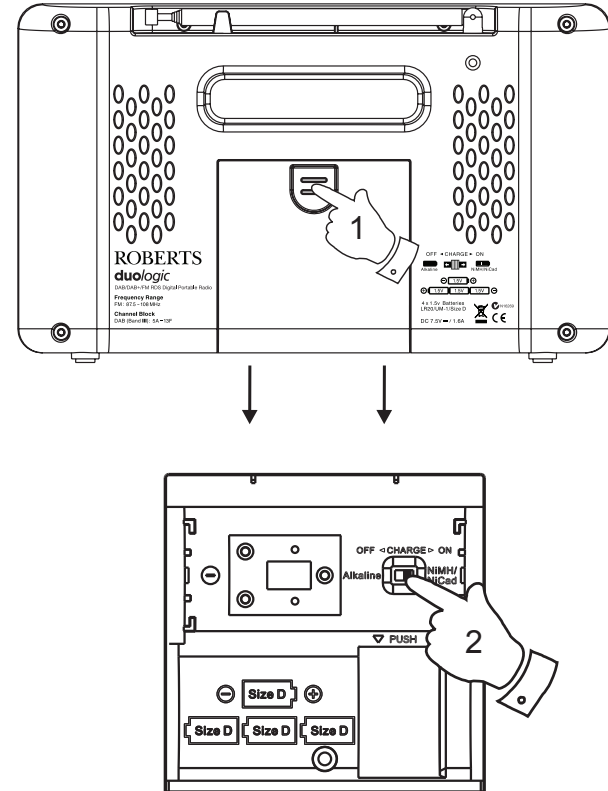

Using the AC adaptor

1. Insert the adaptor plug into the DC in socket on the right hand side of your radio.
2. Plug the adaptor into a standard 13A mains socket outlet. Whenever the adaptor is plugged in to the radio and switched on at the mains the batteries are automatically disconnected. If the adaptor is plugged in to the radio but not switched on then the radio will run from the batteries if fitted.

The AC adaptor should be disconnected from the mains supply and the radio when not in use.

- **IMPORTANT:** The mains adaptor is used as the means of connecting the radio to the mains supply. The mains socket used for the radio must remain accessible during normal use. In order to disconnect the radio from the mains completely, the mains adaptor should be removed from the mains socket outlet completely.

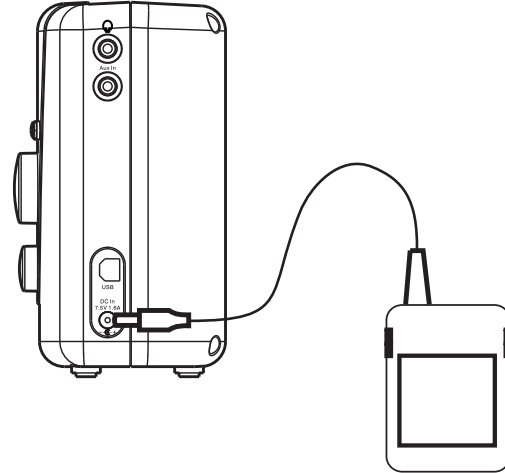

Operating your radio - DAB

1. Carefully extend the telescopic aerial.
2. Press the **On/Off** button to switch on your radio. The display will show 'Welcome to DAB'.
3. If this is the first time the radio is used a scan of the Band III DAB channels will be carried out. If the radio has been used before the last used station will be selected.
4. During the scanning process, the lower line of the display shows a bar-graph indicating progress of the scan.
5. When the scanning is completed the first station (in numeric-alpha order 0...9...A...Z) will be selected.
6. If the station list is still empty after the scan your radio will display 'No DAB station'.
7. If no signals are found it may be necessary to relocate your radio to a position giving better reception. Then, either switch your radio off and on again, or press the **Auto Tune** button to repeat the scan.

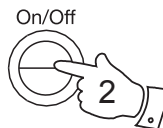

Welcome to DAB
■■■■■■■■■■

AbsR60s DAB
Now tuning...

AbsR60s DAB
Home of the Beat

Note: Radio station name and frequency displays shown in this user guide may differ from those that you see on your radio. Broadcasters may change radio station names that are transmitted, and the frequencies used for DAB and FM radio stations may not be the same in all parts of the country.

Selecting a station - DAB

1. The top line of the display shows the name of the station currently selected.
2. Rotate the **Tuning** control to scroll through the list of available stations on the lower line of the display. Stop rotating the Tuning control when you find the station that you wish to hear.
3. Press and release the **Tuning** control to select the station. The display may show 'Now tuning...' while your radio finds the new station.
4. Adjust the **Volume** control to the required setting.

Note: If after selecting a station the display shows 'No DAB station' it may be necessary to relocate your radio to a position giving better reception.

The use of radio station presets for selecting your preferred radio stations is described on page 18.

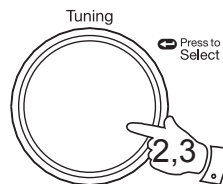

AbsR60s DAB
Home of the Beat

AbsR60s DAB
◆BBC R4 ◆

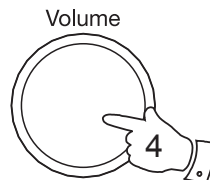

BBC R4 DAB
Now tuning...

Display options - DAB

Your radio has a range of display options when in DAB mode.

1. Press and release the **Info** button to cycle through the various options.



- a. Scrolling text Displays scrolling text messages such as artist/track name, phone in number etc.
- b. Program Type Displays the type of station being listened to e.g. Pop, Classic, News etc.
- c. Multiplex Name Displays the name of DAB multiplex to which the current station belongs.
- d. Time and date Displays the current time and date.
- e. Frequency Displays the frequency of the DAB multiplex for the station listened to.
- f. Bit rate & audio type Displays the digital bit rate & audio type for the station being listened to.
- g. Signal Strength Displays the signal strength for the currently tuned DAB station. The open block in the signal strength graph shows the minimum signal strength needed for good DAB reception. The signal blocks will go up or down showing the changing signal strength as you adjust the telescopic aerial or the radio position.

a BBC R4 DAB
Now playing in t

b BBC R4 DAB
Talk

c BBC R4 DAB
BBC National DAB

d BBC R4 DAB
14:00 19-02-2013

e BBC R4 DAB
12B 225.648MHz

f BBC R4 DAB
128kbps / DAB

g BBC R4 DAB
■■■■■□■■■

Finding new radio stations - DAB

As time passes new stations may become available. To find new stations proceed as follows:-

1. Press and release the **Auto Tune** button. The display will show 'Scanning...' and your radio will perform a scan of the Band III DAB channels. As new radio stations are found the station counter on the right-hand side of the display will increase and the radio stations will be added to the list stored in the radio.

Auto Tune



Secondary services - DAB

1. Certain radio stations have one or more secondary services associated with them. If a radio station has a secondary service associated with it the display will show ">>" next to the station name on the station list. The secondary service will then appear immediately after the primary service as you rotate the tuning control clockwise.
2. Press and release the **Tuning** control to select the station.
3. When the secondary service shuts down, your radio will automatically switch back to the main radio station (or primary service) if it is available.

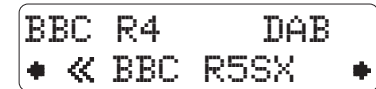
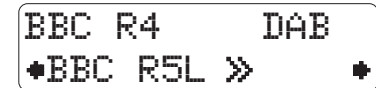
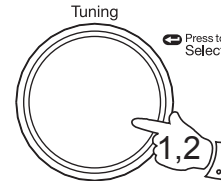

Manual tuning - DAB

Manual tuning allows you to tune directly to the various DAB Band III channels. UK DAB stations located in the range 11B to 12D.

1. Press and hold the **Info** button until the Advanced DAB menu shows on the display and then release the button.
2. Rotate the **Tuning** control until the display shows 'Manual tune'. Press and release the **Tuning** control.
3. Rotate the **Tuning** control to select the required DAB channel.
4. Press and release the **Tuning** control. The clear unfilled rectangle indicates minimum signal level required for satisfactory reception. When a DAB signal is found, the display will show the name of the DAB multiplex. Any new radio stations found will be added to the list stored in the radio. The Signal blocks will go up and down showing the changing signal strength as you adjust the telescopic aerial or the radio position.
5. Press and release the **Tuning** control to return to normal tuning after a few seconds.

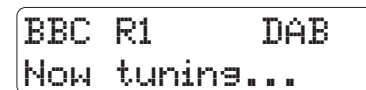
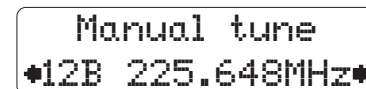
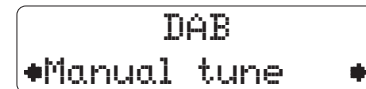
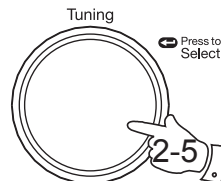
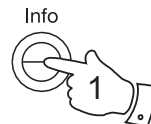

Signal strength display - DAB

1. Repeatedly press and release the **Info** button until the lower line of the display shows signal strength.
2. Position your radio and try moving the aerial so as to give maximum number of black rectangles on signal strength display. Normally, the best reception will be found with the aerial vertical and fully extended.
3. The clear unfilled rectangle indicates minimum signal level required for satisfactory reception.

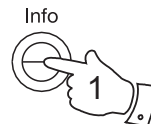

Dynamic Range Control settings - DAB

Dynamic Range Control (also known as DRC) can make quieter sounds easier to hear when your radio is used in a noisy environment.

1. Press the **On/Off** button to switch on your radio.
2. Press and hold in the **Info** button until the Advanced DAB menu shows on the display and then release the button.
3. Rotate the **Tuning** control until the display shows 'DRC'.
4. Press and release the **Tuning** control to enter the adjustment mode.
5. Rotate the **Tuning** control to select the required DRC setting (the default is 0). The current DRC setting will be marked with an asterisk.

DRC 0 - DRC is switched off, Broadcast DRC will be ignored.

DRC 1/2 - DRC level is set to 1/2 that sent by broadcaster.

DRC 1 - DRC level is used as sent by broadcaster.

6. Press and release the **Tuning** control to confirm the setting. The display will return to normal tuning mode.

Note: Not all DAB broadcasts are able to use the DRC function. If the broadcast does not support DRC, then the DRC setting in the radio will have no effect.

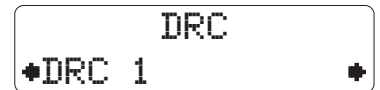
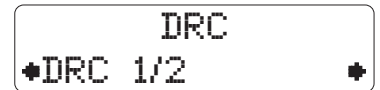
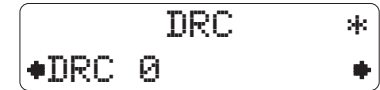
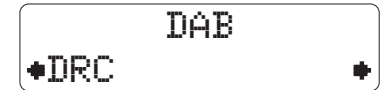
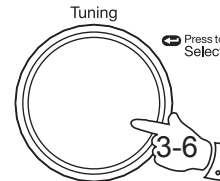
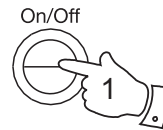

Prune stations - DAB

Over time, some DAB services may stop broadcasting, or may change location and then not be able to receive a station. In order to remove such stations from the DAB station list, the Prune stations function will delete the DAB stations from your station list that can no longer be received.

Stations which cannot be found or which have not been received for a very long time are shown in the station list with a question mark.

1. Press the **On/Off** button to switch on your radio.
2. Press and release the **DAB/FM** button until the DAB mode is selected.
3. Press and hold the **Info** button until the Advanced DAB menu shows on the display and then release the button.
4. Rotate the **Tuning** control until 'Prune' appears on the display. Press and release the **Tuning** control.
5. Rotate the **Tuning** control to highlight 'Yes'. Press and release the **Tuning** control to cause the stations list to be pruned, eliminating unavailable stations.
6. If you do not wish to prune stations highlight 'No' in step 5 and then press and release the **Tuning** control. The display will revert back to the previous display.

Note: If you have moved to a different part of the country you should also carry out a search for new stations (please see the section 'Finding new stations' on page 10).

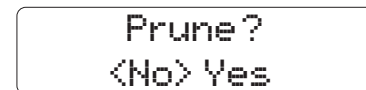
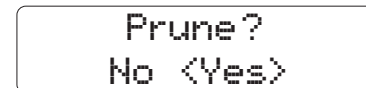
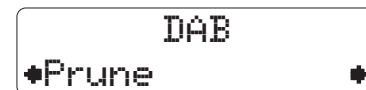
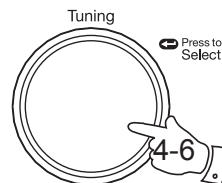
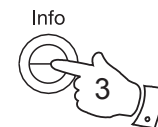
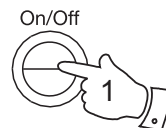

Operating your radio - Search tuning - FM

1. Carefully extend the telescopic aerial fully.
2. Press the **On/Off** button to switch on your radio.
3. Press and release the **DAB/FM** button until the FM mode is selected.
4. Press and immediately release the **Auto tune** button, your radio will scan in an upwards direction (low frequency to high frequency) and stop automatically when it finds a station of sufficient strength.
5. After a few seconds the display will update. The display will show the frequency of the signal found. If the signal is strong enough and there is RDS data present then the radio will display the station name.
6. To find other stations, press and release the **Auto tune** button as before.
7. To scan the FM band in a downwards direction (high frequency to low frequency) press and hold down the **Auto tune** button for 2 seconds and then release.
8. When the waveband end is reached your radio will recommence tuning from the opposite waveband end.
9. Adjust the **Volume** control to the required setting.

The use of radio station presets for selecting your preferred radio stations is described on page 18.

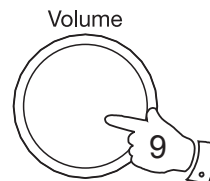
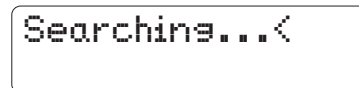
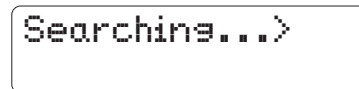
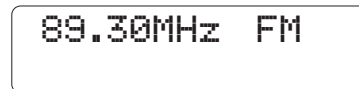
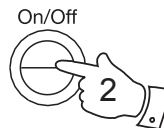

Note:

If you find that FM reception is poor, try repositioning the telescopic aerial. Fully extend and position vertically for optimum reception.

If you find that an FM broadcast has a lot of background hiss, this may often be reduced by setting the radio into Mono reception mode for the current FM station. Please refer to the section 'Stereo / Mono setting - FM' on page 20 for further details.

Manual tuning - FM

1. Carefully extend the telescopic aerial fully.
2. Press the **On/Off** button to switch on your radio.
3. Press and release the **DAB/FM** button until the FM mode is selected.
4. Rotate the **Tuning** control to tune to a station. With each click of the control the frequency will change up or down by 50 kHz.
5. When the waveband end is reached the radio will recommence tuning from the opposite waveband end.
6. Set the **Volume** control to the desired settings.
7. To switch off your radio press the **On/Off** button.

Note:

If you find that FM reception is poor, try repositioning the telescopic aerial. Fully extend and position vertically for optimum reception.

If you find that an FM broadcast has a lot of background hiss, this may often be reduced by setting the radio into Mono reception mode for the current FM station. Please refer to the section 'Stereo / Mono setting - FM' on page 20 for further details.

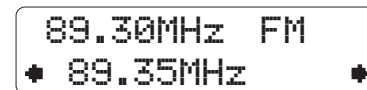
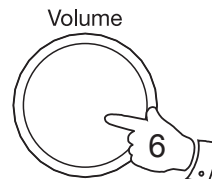
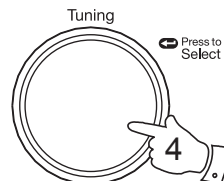
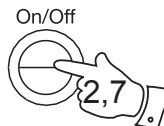

Display options - FM

Your radio has a range of display options when in FM mode.

1. Press and release the **Info** button to cycle through each of the options.

- a. Scrolling text Displays scrolling text messages such as artist/track name, phone in number etc.
- b. Program type Displays type of station being listened to e.g. Pop, Classic, News, etc.
- c. Time and date Displays the current time and date.
- d. Frequency Displays frequency of the station being listened to.
- e. Audio type Display shows the audio type for the currently tuned FM station.

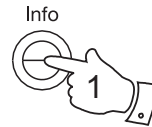

a BBC R4 FM
Now playing in t

b BBC R4 FM
Pop Music

c BBC R4 FM
11:51 19-02-2013

d BBC R4 FM
89.30MHz

e BBC R4 FM
Mono

Note: Your radio will display 'NO Radio Text' on the lower line of the display if there is no scrolling text available and 'NO PTY' if there is no programme type information.

Favourite button

Your radio is fitted with a button which when pressed will automatically select the required waveband and tune to your Favourite radio station. With this button you can store one favourite station from either the DAB or FM wavebands.

To set up your favourite station, follow these steps:

1. Carefully extend the telescopic aerial and switch on your radio.
2. Select the desired waveband (DAB or FM) and tune into the required radio station as described on the preceding pages.
3. Press and hold down the **Favourite** button (for 5 seconds) until the display shows 'My Fav. Saved'.

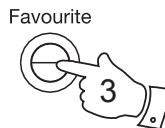

BBC R4 DAB
My Fav. Saved

Recalling your favourite station

1. Carefully extend the telescopic aerial and switch on your radio.

If your radio is in Auxiliary Input mode, press and release the **DAB/FM** button to select normal radio operation.

2. Momentarily press the **Favourite** button, your radio will automatically select the DAB or FM waveband as needed and then tune to the radio station stored in the favourite memory.

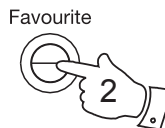

BBC R4 DAB
Now playing in t

Preset stations - DAB and FM

To make it easier for you to tune your radio to the stations that you prefer, you may store selected radio stations as presets. Your radio holds presets separately for DAB and FM radio modes.

You may set as many or as few presets as you like in each mode.

You can easily switch between displaying all DAB stations (or all FM frequencies) and displaying only those that you have set as presets.

Any station or frequency which has been marked as a preset can easily have the mark cancelled should your preferences or needs change.

Presets are retained when your radio is switched off.

1. To setup your preset stations, tune into the required station.
2. Press and hold down the **Preset** button until the displays shows a tick symbol next to the radio station name or frequency. This indicates that the radio station is marked as a preset. To cancel the preset mark, press and hold the **Preset** button again.
3. Repeat steps 1 and 2 as needed for any other stations that you want as presets.
4. To view only the preset stations for the currently selected waveband when tuning, press and release the **Preset** button so that the heart symbol shows in the display.
5. To listen to one of the preset radio stations, rotate the **Tuning** control until the required radio station is displayed. Press and release the **Tuning** control to select and tune to that station.
6. To cancel the preset stations view, press and release the **Preset** button so that the heart symbol disappears from the display. Your radio will then be able to access the full station list using the **Tuning** control.

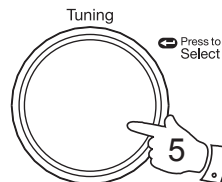

Scan sensitivity setting - FM

Your radio will normally scan for FM broadcasts which are strong enough to give good reception. However, you may wish the Auto-scan function to also be able to find weaker signals, possibly from more distant radio transmitters. Your radio includes a local / distant option for the Auto-scan function.

1. Press the **On/Off** button to switch on your radio.
2. If needed, press and release the **DAB/FM** button until the FM mode is selected.
3. Press and hold the **Info** button until the Advanced FM menu shows on the display and then release the button.
4. Rotate the **Tuning** control until 'FM Scan Zone' shows on the display. Press and release the **Tuning** control.
5. Rotate the **Tuning** control to switch between Local and Distant options on the lower line of the display. The current setting will be marked with an asterisk. The Distant option will allow the radio to find weaker signals when scanning.
6. Press and release the **Tuning** control to confirm your selection. The radio will then revert to the normal information display. The Local or Distant setting is stored in the radio and remains in force until changed or until a System Reset.

Note: The initial setting (out of the box, or after a System Reset) causes the radio to ignore weaker (or more distant) signals.

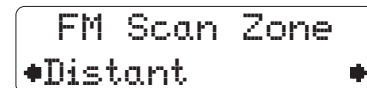
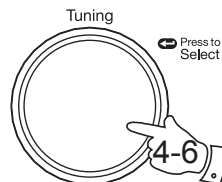
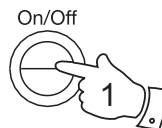

Stereo / Mono setting - FM

Your radio will play stereo FM broadcasts in stereo provided that the received signal is of adequate strength. However, as a stereo signal becomes weaker the audio signal will become poorer. It may be preferable to force the radio to play the station in mono in order to reduce the level of background hiss.

1. If a station being received is weak some hiss may be audible (especially when listening using headphones). To reduce this, press and release the **Tuning** control so that the display shows 'Switch to Mono'. Your radio will switch to mono mode.
2. To return to stereo mode press and release the **Tuning** control so that the display shows 'Switch to Auto'. Your radio will switch to stereo mode.

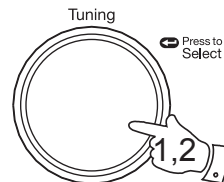

BBC R4 FM
Switch to Mono

BBC R4 FM
Switch to Auto

Software version

The software display cannot be altered and is just for your reference.

1. To view the software version on the display, ensure your radio is in DAB mode.
2. Press and hold the **Info** button until the Advanced DAB menu shows on the display and then release the button.
3. Rotate the **Tuning** control until the display shows 'SW version'. Press the **Tuning** control the software version will appear on the display.
4. Press and release the **Info** button to revert to the normal display mode.



DAB
*SW version *

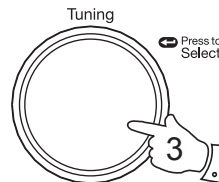

SW version
dab-mmi-FS2052-0

System reset

If your radio fails to operate correctly, or some digits on the display are missing or incomplete, it may be possible to restore normal operation by carrying out a System Reset operation on your radio. This will restore the radio's settings to their factory defaults. No presets will be stored, and the list of DAB radio stations will be empty.

If you have moved to a different part of the country and you wish to erase local DAB radio stations that are no longer available from the stored list, then you may carry out this procedure. Your radio will automatically re-scan for the DAB stations available at your current location when it restarts.

1. Press the **On/Off** button to switch on your radio.
2. Press and hold the **Info** button until the Advanced DAB or FM menu shows on the display and then release the button.
3. Rotate the **Tuning** control until the display shows 'Factory Reset', then press and release the **Tuning** control. 'Press SELECT to confirm reset' will show on the display.
4. If you wish to perform the reset operation, press and release the **Tuning** control **one more time**. A full reset of your radio will be performed. All presets and station lists will be erased.
5. After a system reset a scan of the DAB band will be performed.

In case of malfunction due to electrostatic discharge, reset the product (temporary disconnection of the power adaptor or removal of batteries may be required) to resume normal operation.

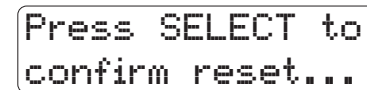
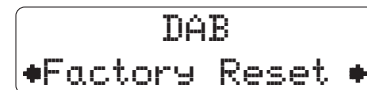
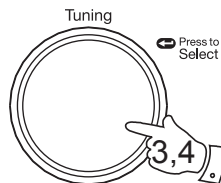

Headphone socket

A 3.5mm **Headphone** Socket located on the right side of your radio is provided for use with either headphones or an earpiece. Inserting a plug automatically mutes the internal loudspeaker.

Please be aware that the sensitivity of headphones can vary widely. We therefore recommend setting the volume to a low level before connecting headphones to the radio.

IMPORTANT: Excessive sound pressure from earphones and headphones can cause hearing loss.



To prevent possible hearing damage, do not listen at high volume levels for long periods.

Auxiliary input socket

1. Connect a stereo or mono audio source (i.e. CD player, MP3 player, etc.) to the **Auxiliary input** socket.
2. Press the **On/Off** button to switch on the radio. Press and release the **DAB/FM** button until the display shows 'AUX IN'.

Note: The Auxiliary Input mode can only be selected when a plug is inserted in the socket.

3. Adjust the **Volume** control on your player and on the radio for comfortable listening.
4. Remove the cable from the **Auxiliary input** socket or press and release the **DAB/FM** button to cancel Auxiliary Input mode.

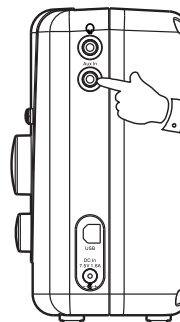
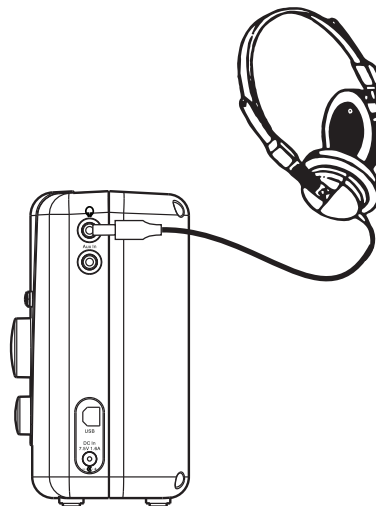

A Few Words about Batteries...

Your Roberts **duologic** radio has been designed to use a choice of power sources. You may plug it into the mains using the supplied high-efficiency adaptor, or for listening away from the mains you may use either alkaline or rechargeable batteries. We do not recommend the use of carbon-zinc or zinc-chloride batteries.

It is very important that you read the advice and warnings given below.

- 1) Whichever type of batteries you choose to use, it is very important that the battery selection switch under the cover is set to the correct type.
 - a. If no batteries are fitted, then set the switch to the Alkaline position (to the left as viewed from the back of the radio). This position minimises the power consumption when the radio is powered from the mains.
 - b. If Alkaline batteries are fitted, then set the switch to the Alkaline position (to the left as viewed from the back of the radio).
 - c. If Rechargeable batteries are fitted, then set the switch to the NiMH/NiCad position (to the right as viewed from the back of the radio). Your radio is designed to use Nickel-Metal-Hydride or Nickel Cadmium rechargeable batteries. No other type of rechargeable battery should be used in the radio.
- 2) **NEVER** mix old and new Alkaline batteries. The old batteries may suffer damage and leak which will damage your radio and whatever the radio is standing on.
- 3) **NEVER** mix old and new Rechargeable batteries. This may result in unreliable charging and shortened battery life. Never mix Rechargeable batteries of different types or capacities even if they are new.
- 4) **NEVER** mix Alkaline and Rechargeable batteries. The recharging of Alkaline batteries can be very dangerous.

Rechargeable batteries

Your **duologic** radio uses a range of methods to ensure correct and safe charging of Rechargeable Nickel-Metal-Hydride or Nickel Cadmium batteries. These work to protect your batteries from excessive charge and discharge. These protections can only work properly if the advice above is followed. In particular, the radio will not be able to correctly charge batteries if they are a mixture of different brands, or different ages, or different capacities.

We recommend that all the rechargeable batteries used in your radio are bought together as a set. They should always be charged together and discharged together and not "borrowed" from time to time from other applications. This will ensure that they give their optimum performance in your radio.

We recommend that the rechargeable batteries that you use should be from a quality brand, and should be of at least 2500mAh capacity. Batteries of this capacity should be able to power your radio for up to 20 hours depending upon the volume of the radio, whether DAB or FM mode is used (DAB mode uses slightly less power than FM), and also depending on the condition of the batteries.

Before you first install a new set of rechargeable batteries into your radio you should first make sure that the battery type switch beneath the battery cover is in the NiMH/NiCad position. Install the batteries arranging them as shown on the back of the radio. Plug the mains adaptor into a mains socket and then into the radio. While the batteries are charging the charge indicator should show a flashing green light. When the batteries are fully charged the indicator will stop flashing and will show a steady green light. The time taken to charge the batteries will depend on how much charging they require. New batteries may be partly charged when first fitted, but it is normal for a set of batteries to take several hours to charge fully (this can be between 5 and 8 hours depending on the battery capacity and their initial state of charge).

If you use the radio powered from the batteries, the charge indicator light will be off until the batteries are exhausted. The charge indicator light will then show red for a short while before the radio switches itself off. It does this in order that the batteries are not excessively discharged. This would otherwise damage the batteries and shorten their life.

If you use the radio powered from the mains with rechargeable batteries fitted, the charging process is suspended until you switch off the radio. When you switch off the radio using its On/Off button charging will then resume. If the batteries have already been charged then they will only charge for a few more minutes before the charge indicator stops flashing.

If you only listen to your radio for short periods, you do not need to connect your radio to the mains to charge the batteries every time that you use it. However, if the radio is not to be used for a few weeks, then we recommend that the batteries are fully charged (charge light shows steady green) before the radio is put to one side.

If you intend not to use your radio for some months, then we recommend that the batteries are removed and put away, keeping them in a cool place out of reach of children, away from moisture and such that no metal object can contact the battery terminals.

With care, rechargeable batteries can last a long time and can operate for many hundreds of charge and discharge cycles. When your rechargeable batteries can no longer power your radio adequately, please dispose of them thoughtfully.

To avoid danger and risk of injury, please follow these guide lines

Improper use of batteries may result in leakage of fluid, overheating or explosion. Battery fluid is corrosive and may also be toxic. Battery fluid can cause skin burns, can damage the eyes, and can be harmful if swallowed.

1. Keep batteries out of the reach of children.
2. Do not heat, open, puncture, mutilate or dispose of batteries by burning.
3. Do not mix different battery types or old and new batteries. Always replace all the batteries at the same time.
4. Do not carry or store batteries such that metal objects may contact the end caps.
5. Remove batteries from the radio if they are worn out or if you are storing it for a long time.
6. Remove old or worn out batteries promptly, and recycle or dispose of them according to the regulations applicable to your location.
7. If a battery does leak, remove all batteries from the product, taking care to avoid directly touching the leaked fluid. If the fluid contacts skin or clothes wash with water immediately. Before inserting new batteries, thoroughly clean the battery compartment with a damp paper towel, or follow the battery manufacturer's advice for clean up.

Display backlight

1. When using the radio powered from batteries, the display backlight will be switched on for approximately 12 seconds when any button is pressed.
2. When your radio is powered by the AC mains using the supplied mains adaptor the display backlight will always be on whenever the radio is switched on.

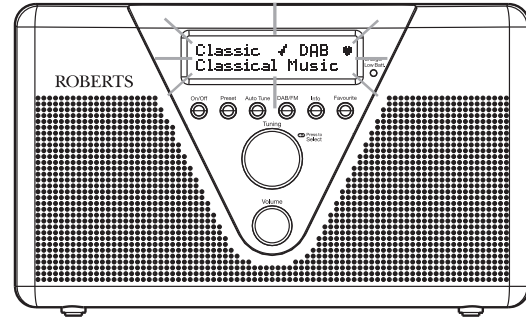

Software upgrades

In the event that any software update is made available for your radio, information on how to update your radio will be made available via our website at <http://www.robertsradio.com>

General

Do not allow this radio to be exposed to water, steam or sand. Do not leave your radio where excessive heat could cause damage such as in a parked car where the heat from the sun can build up even though the outside temperature may not seem too high. It is recommended that the DAB band be used wherever possible as better results in terms of quality and freedom from interference will usually be obtained than on the FM band.

The name plate is located on the rear of your radio.



- Your radio should not be exposed to dripping or splashing and that no objects filled with liquids, such as vases, shall be placed on the radio.
- It is recommended to operate the product such that there is a minimum distance (10cm recommended) to adjacent objects in order to ensure good ventilation.
- The ventilation of the product should not be restricted by covering it or its ventilation openings with items such as newspapers, tablecloths, curtains etc.
- No naked flame sources such as lighted candles should be placed on the product.
- It is recommended to avoid using or storing the product at extremes of temperature. Avoid leaving the unit in cars, on window sills, in direct sunlight etc.

Specifications

Power Requirements

Mains AC 100 \sim 240V 50/60Hz (adaptor)
Batteries 4 x LR20 (D size)

Battery Life

Up to 100 hours of listening for 4 hours a day at normal volume using alkaline cells.

Frequency Coverage

FM 87.5-108MHz
DAB 174.928 - 239.200MHz

Circuit features

Loudspeaker 2 x 76mm

Output Power 2 x 1 watt

Headphone socket 3.5mm dia.

Auxiliary Input socket 3.5mm dia.

Aerial System FM Telescopic aerial

DAB Telescopic aerial

The Company reserves the right to amend the specification without notice.

Guarantee

This product is guaranteed for twelve months from the date of purchase by the original owner against failure due to faulty workmanship or component breakdown, subject to the procedure stated below. Should any component or part fail during this guarantee period it will be repaired or replaced free of charge.

The guarantee does not cover:

1. Damage resulting from incorrect use.
2. Consequential damage.
3. Product with removed or defaced serial numbers.

N.B. Damaged or broken telescopic aerials will not be replaced under guarantee.

Procedure:

Any claim under this guarantee should be made through the dealer from whom the product was purchased. It is likely that your Roberts dealer will be able to attend to any defect quickly and efficiently, but should it be necessary the dealer will return the product to the company's service department for attention. In the event that it is not possible to return the product to the Roberts dealer from whom it was purchased, please contact Roberts Radio using the contact details on the www.robertsradio.com website.

For product repairs falling outside the guarantee period, please refer to the "customer care" tab on the www.robertsradio.com website.

These statements do not affect the statutory rights of a consumer.

ROBERTS RADIO LIMITED

PO Box 130
Mexborough
South Yorkshire
S64 8YT

Website: <http://www.robertsradio.com>

© 2009, 2014 Roberts Radio Limited

