

ROBERTS

Sound for Generations

CR9986

Dual Alarm CD Clock Radio



Please read this manual before use

Contents

<i>Contents</i>	1	<i>Setting alarms to wake to CD</i>	16
<i>Controls</i>	2-3	<i>Setting alarms to wake to CD programme</i>	17
<i>Switching on and setting the time</i>	4	<i>Snooze control</i>	18
<i>Listening to the radio</i>	5	<i>Sleep function</i>	18
<i>Compact discs</i>	6	<i>Auto dimmer</i>	19
<i>CD-R/CD-RW discs</i>	6	<i>Headphones</i>	19
<i>Inserting a CD</i>	7	<i>Specifications</i>	20
<i>Playing a CD</i>	8	<i>Circuit features</i>	20
<i>Selecting a track</i>	9	<i>General</i>	21
<i>Search function</i>	9	<i>Guarantee</i>	22
<i>CD repeat mode</i>	10		
<i>CD random play</i>	10		
<i>Warning</i>	10		
<i>Programmed play</i>	11		
<i>Checking a programme</i>	11		
<i>Erasing a programme</i>	11		
<i>Setting alarm times</i>	12		
<i>Setting alarm 1</i>	12		
<i>Setting alarm 2</i>	12		
<i>Checking alarm times</i>	13		
<i>Setting alarms to wake to buzzer</i>	14		
<i>Setting alarms to wake to radio</i>	15		

Controls

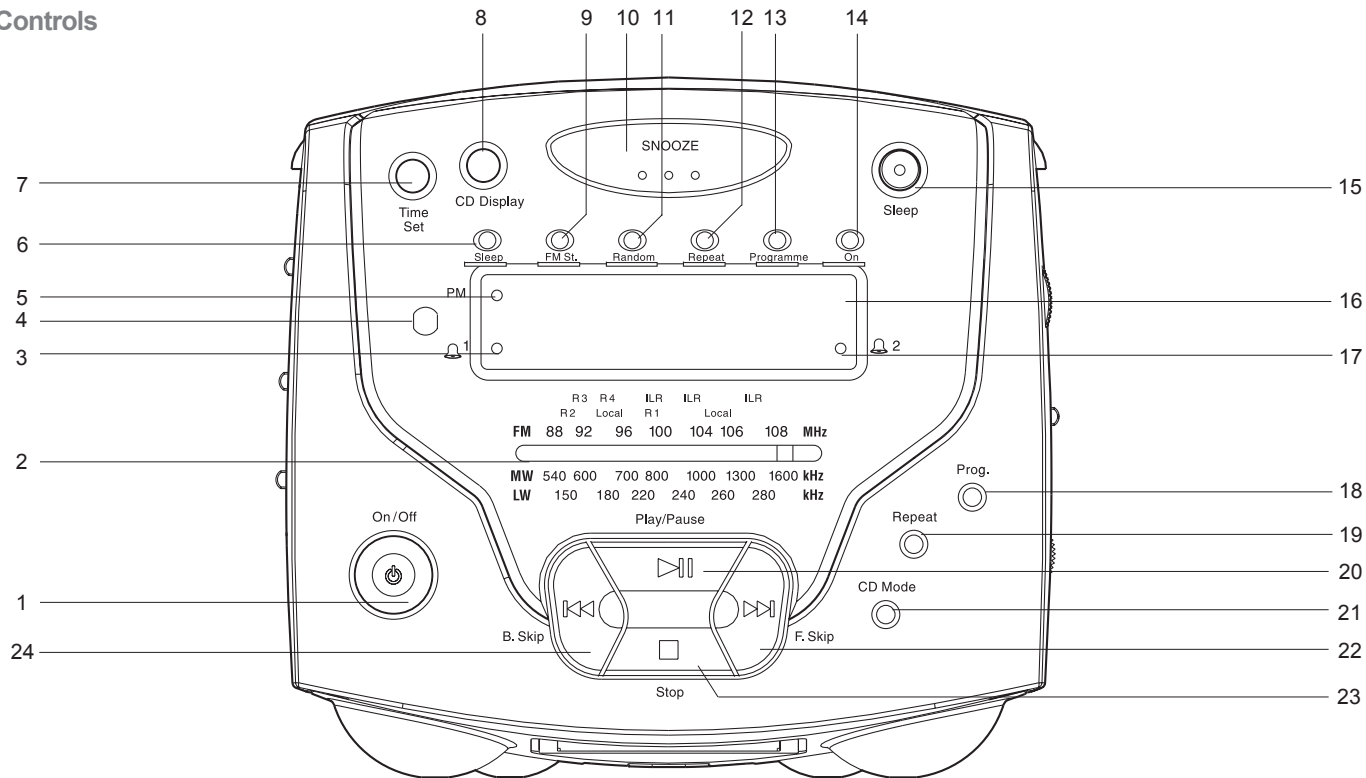

- | | | | | |
|----------------------------|------------------------|-------------------------|--------------------------|--------------------|
| 1. On/Off button | 6. Sleep indicator | 11. Random indicator | 16. CD/Clock Display | 21. CD Mode button |
| 2. Dial scale with pointer | 7. Time Set button | 12. Repeat indicator | 17. Alarm 2 indicator | 22. F.Skip button |
| 3. Alarm 1 indicator | 8. CD Display button | 13. Programme indicator | 18. Programme button | 23. CD Stop button |
| 4. Auto Dimmer | 9. FM stereo indicator | 14. On indicator | 19. Repeat button | 24. B.Skip button |
| 5. PM indicator | 10. Snooze button | 15. Sleep button | 20. CD Play/Pause button | |

Controls

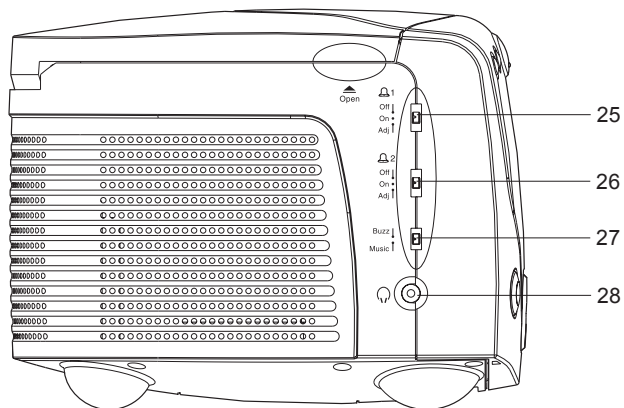

- 25. Alarm 1 function switch
- 26. Alarm 2 function switch
- 27. Alarm Mode switch
- 28. Headphone socket

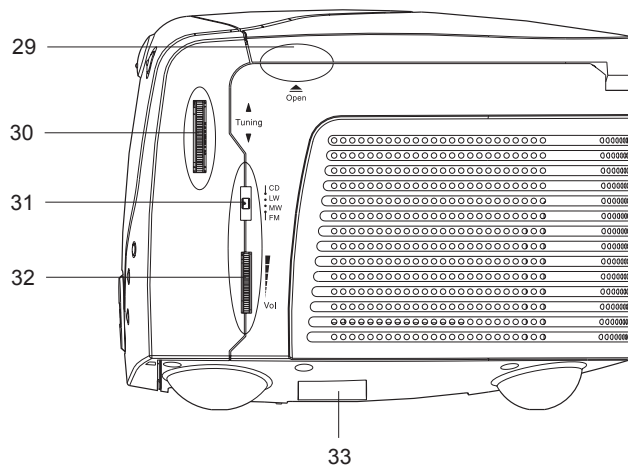

- 29. CD Door handle
- 30. Tuning control
- 31. Function switch
- 32. Volume control
- 33. Battery compartment (on underside)

Switching on and setting the time

Before using your CD clock radio you must first set the correct time.

1. Place the unit on a flat surface. Plug the mains lead into a wall socket and switch on the wall socket.
2. The clock display will show 12:00. Ensure that the **Alarm 1** and **Alarm 2 function switches** are set to the 'Off' position.
3. Press and hold down the **Time Set button**. The time will flash in the display.
4. Whilst holding down the **Time Set button** press the **B.Skip button** to set the minutes and the **F.Skip button** to set the hour. Release the buttons when the correct time is reached. The clock uses a 12 hour display with a **PM indicator**. Ensure that the correct 12 hour cycle is selected.

IMPORTANT: The mains plug is used as the means of connecting the clock radio to the mains supply. The mains socket used for the clock radio must remain accessible during normal use. In order to disconnect the clock radio from the mains completely, the mains plug should be removed from the mains socket outlet completely.

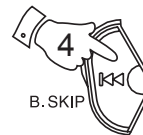
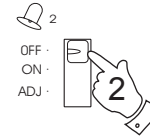
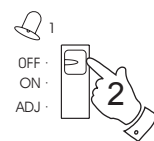
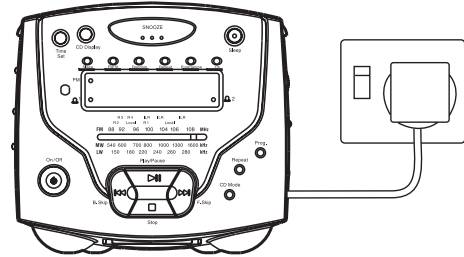

Listening to the Radio

1. Switch on your CD clock radio by pressing the **On/Off button**. The **On indicator** LED will light.
2. Slide the **Function switch** to the required waveband.



3. Tune in to the desired station by rotating the **Tuning control**. The station frequency is indicated in the dial scale.

The **Wire aerial** located on the rear of your CD clock radio is for FM reception. The wire should be fully extended and positioned for optimum reception.

For MW and LW reception there is a built in ferrite aerial. Rotate your CD clock radio to the position giving best reception.



4. Adjust the volume by rotating the **Volume control**.
5. When the **Function switch** is set to FM and the station being received is an FM Stereo station the **FM Stereo indicator** will light.

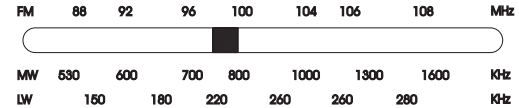

6. The radio can be switched off by pressing the **On/Off button**. The **On indicator** will switch off.

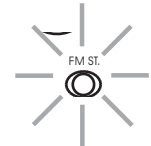
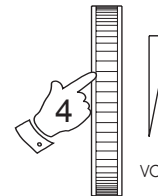

Compact discs

Use only Digital Audio CDs which have the



symbol.

Never write on a CD or attach any sticker to the CD. Always hold the CD at the edge and store it in its box after use with the label facing up.

To remove dust and dirt, breathe on the CD and wipe it with a soft, lint-free cloth in a straight line from the centre towards the edge.

Cleaning agents may damage the CD

Do not expose the CD to rain, moisture, sand, or to excessive heat. (e.g. from heating equipment or in motor cars parked in the sun).

CD-R/CD-RW discs

Your CD clock radio can playback CD-DA format audio CD-R/CD-RW discs that have been finalised* upon completion of recording.

Your CD clock radio may fail to playback some CD-R/CD-RW discs due to poor recording of the CD-R/CD-RW disc.

**Finalising enables a CD-R/CD-RW disc to playback on audio CD players such as your CD clock radio.*

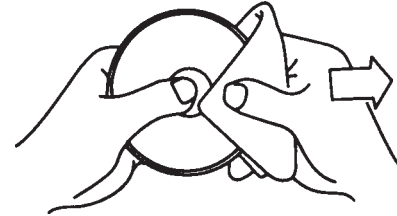

Inserting a CD

1. Press the **On/Off button** to switch on your CD clock radio. The **On indicator** will light.
2. Set the **Function switch** to CD.
3. To open the CD compartment, lift the **CD door** by the handle as shown.
4. Press the CD onto the spindle until it clicks into place. Close the **CD door**. The CD player will scan the contents of the CD and the total number of tracks will appear on the display. After a short time the display will revert to showing time.

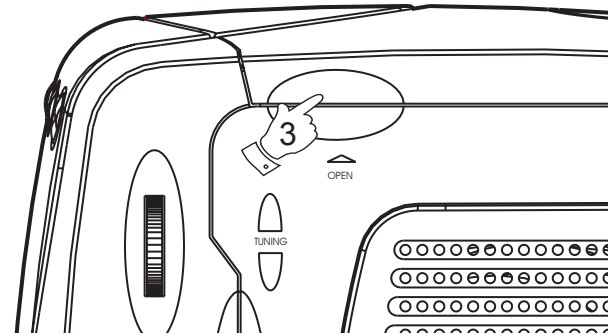

Playing a CD

1. Press the **Play/Pause button** to start playback. The display will show the track number. After a short time the display will revert to showing time.
2. Set the **Volume control** to the required setting.
3. To display the CD track number press the **CD display button**.
4. To pause playback press the **Play/Pause button**. The track number will flash in the display. To resume playback press the **Play/Pause button** again.
5. To stop playback, press the **CD Stop button**. The display will revert to showing time.
6. To take out the CD, lift the **CD door** by the handle and remove the CD from the spindle. The **CD door** should only be opened when the CD is in Stop mode.

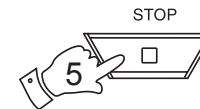
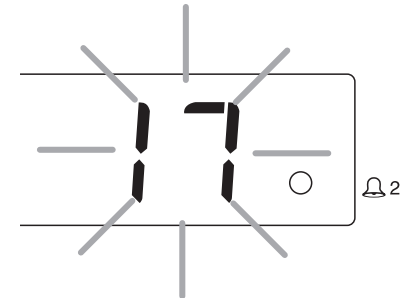
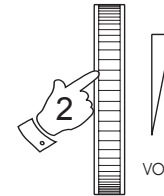

Selecting a track

1. Whilst the CD is playing, press either the **F.skip** or **B.skip buttons** to change to the desired track, the track number will show in the display. You can also skip tracks when the player is in stop mode. Skip to the desired track using the **F.skip** or **B.skip buttons**.
2. Press the **Play/Pause button** to play the selected track. The track number will show on the display and after a short time the display will revert to showing time.

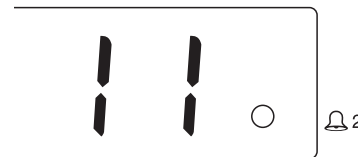
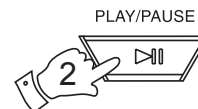
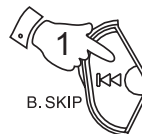

Search function

1. Whilst the CD is playing, press and hold down either the **F.skip** or **B.skip buttons**.
2. Release the button when the desired part of the track is reached.

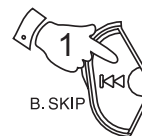

CD repeat mode

1. Whilst the CD is playing press the **Repeat button** once to repeat the current track. The **Repeat indicator** will flash.
2. Press the **Repeat button** again to repeat all tracks on the CD. The **Repeat indicator** will light up.
3. Press the **Repeat button** again to return to normal play. The **Repeat indicator** will switch off.

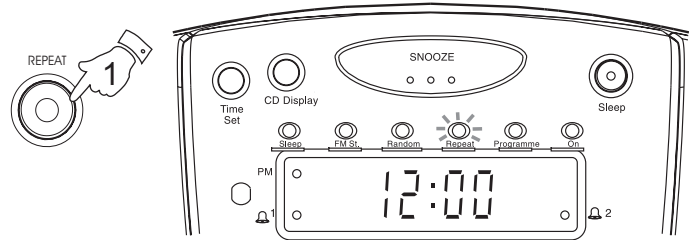

CD Random play

1. Press the **CD Mode button** to play all tracks on the CD in random order. The **Random indicator** will light up. The tracks are played in random order until all tracks have been played.
2. Press the **CD Mode button** again to return to normal play. The **Random indicator** will switch off.

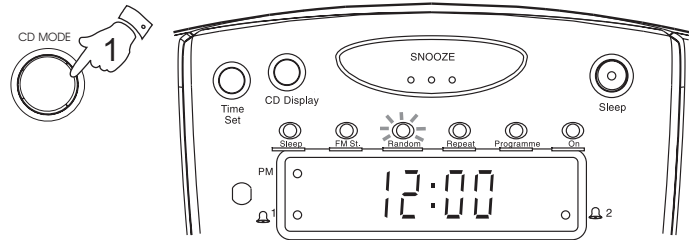

Warning

CLASS 1 LASER PRODUCT means that the laser's construction makes it inherently safe so that the legally prescribed maximum permissible radiation values can never be exceeded

Caution: Using any equipment or devices other than those described and specified in these operating instructions, or tampering with the unit in any way, can result in dangerous exposure to radiation.

*If you need any further advice, please call our Technical Helpline on :-
020 8758 0338 (Mon-Fri)*

**CLASS 1
LASER PRODUCT**

Programmed play

By programming the player you can play up to 20 tracks in any desired order.

1. Whilst the CD is in Stop mode, press the **Program button**. The display will show 'P 01' and the **Program indicator** will flash.

Note: the display will revert to showing time after 10 seconds of inactivity.

2. Select the first track using the **F.skip** or **B.skip** buttons. The track number will flash on the display. Store this track by pressing the **Program button**.
3. Repeat the above steps until you have completed your program (maximum 20 tracks). Press the **Play/Pause** button to commence play of the selected tracks.

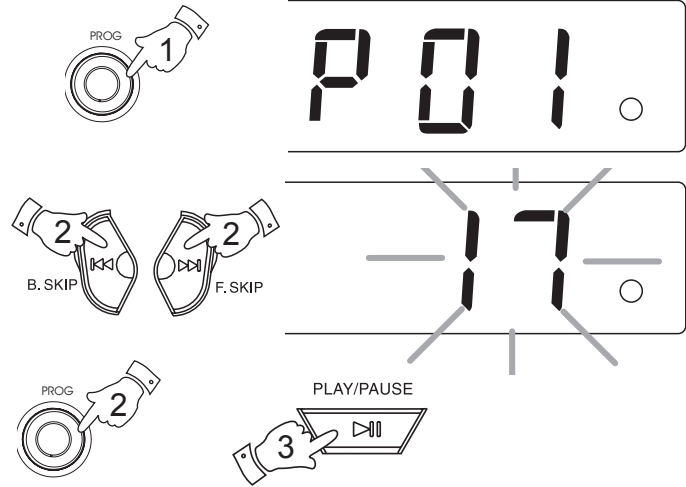

Checking a programme

1. Whilst the CD is in Stop mode, repeatedly press the **Program button** to step through the tracks programmed.

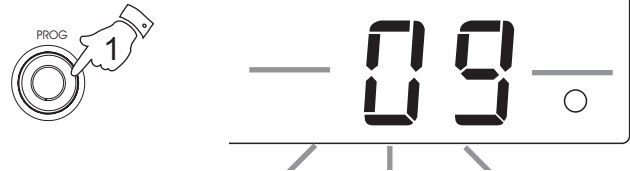

Erasing a programme

1. Whilst the CD is in Stop mode, press the **Program button**. The **Program indicator** will flash.
2. Press the **CD Stop button** to erase the programme. Programmes are also erased by opening the **CD door**, changing position of the **Function switch** and interrupting the mains supply.



Setting alarm times

The alarms can be set to wake you by a buzzer, CD or the radio. Your CD clock radio has 2 separate alarms which can be set to activate at different times.

Setting Alarm 1

1. Slide the **Alarm 1 function switch** to the 'Adj' position.
2. Press the **B.Skip button** to set minutes and the **F.Skip button** to set the hour. Release the buttons when the correct time is reached. The clock uses a 12 hour display with a **PM indicator**. Ensure that the correct 12 hour cycle is selected.
3. Return the **Alarm 1 function switch** to the 'Off' position. The display will revert to showing time and the **Alarm 1 indicator** will go off.

Note: Incorrect display will result if both the Alarm function switches are set to the 'Adj' position.

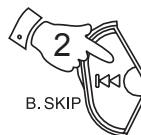

Setting Alarm 2

1. Slide the **Alarm 2 function switch** to the 'Adj' position.
2. Press the **B.Skip button** to set minutes and the **F.Skip button** to set the hour. Release the buttons when the correct time is reached. The clock uses a 12 hour display with a **PM indicator**. Ensure that the correct 12 hour cycle is selected.
3. Return the **Alarm 2 function switch** to the 'Off' position. The display will revert to showing time and the **Alarm 2 indicator** will go off.

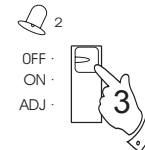
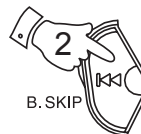
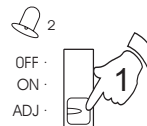

Checking the Alarm Times

1. To check Alarm 1 time, set the **Alarm 1 function switch** to the 'Adj' position. Alarm 1 time will flash in the display.
2. Return the **Alarm 1 function switch** to the 'Off' position. The display will revert to showing time.
3. To check Alarm 2 time, set the **Alarm 2 function switch** to the 'Adj' position. Alarm 2 time will flash in the display.
4. Return the **Alarm 2 function switch** to the 'Off' position. The display will revert to showing time.

Note: Incorrect display will result if both the Alarm function switches are set to the 'Adj' position.

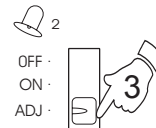
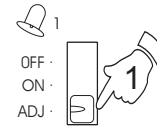

Setting the alarms to wake to buzzer

1. Set the alarm time as previously described. Set the **Alarm mode switch** to the 'Buzz' position.
2. Set the **Alarm 1 or Alarm 2 function switch** to the 'On' position. The corresponding **Alarm indicator** will light.
3. Press the **On/Off button** to switch off your CD clock radio, the **On indicator** will switch off.
4. The buzzer alarm will sound every day at the preset time for 90 minutes. To switch off the alarm until the next day press the **On/Off button**.
5. To switch off the alarms permanently set the **Alarm 1 or Alarm 2 function switch** to the 'Off' position.

Note: Alarm 1 has a low tone Alarm 2 has a high tone.

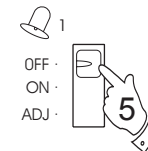
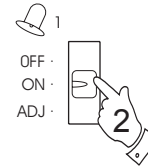

Setting the alarms to wake to radio

1. Set the alarm time as previously described. Set the **Alarm Mode switch** to the 'Music' position.
2. Set the **Alarm 1** or **Alarm 2 function switch** to the 'On' position. The corresponding **Alarm indicator** will light.
3. Select the required waveband using the **Function switch** and ensure that a station is tuned in
4. Set the **Volume control** to the desired level.
5. Press the **On/Off button** to switch off your CD clock radio, the **On indicator** will switch off.
6. The radio alarm will sound every day at the preset time for 90 minutes. To switch off the alarm until the next day press the **On/Off button**.
7. To switch off the alarms permanently set the **Alarm 1 or Alarm 2 function switch** to the 'Off' position.

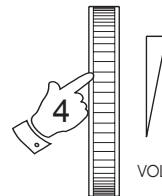
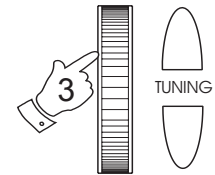
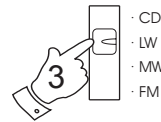
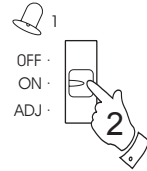

Setting the alarms to wake to CD

1. Set the alarm time as previously described. Set the **Alarm Mode switch** to the 'Music' position.
2. Set the **Alarm 1** or **Alarm 2 function switch** to the 'On' position. The corresponding **Alarm indicator** will light.
3. Set the **Function switch** to the 'CD' position, insert a CD and ensure that the **Volume control** is set to the desired level.
4. Press the **On/Off button** to switch off your CD clock radio, the **On indicator** will switch off.

Important: Failure to switch off the unit will result in non operation of the CD at alarm time.

5. The CD will play every day at the preset time for a maximum of 90 minutes. To switch off the alarm until the next day press the **On/Off button**.
6. To switch off the alarms permanently set the **Alarm 1 or Alarm 2 function switch** to the 'Off' position.

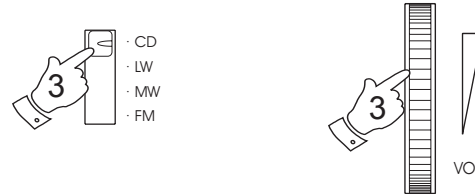
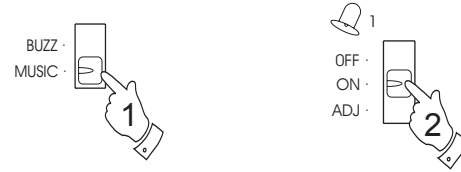

Setting the alarm to wake to CD programme

1. Set the alarm to wake to CD as previously described.
2. Programme your favourite tracks as described earlier.
3. Press the **Play/Pause button** followed by the **CD Stop button**.
4. Press the **On/Off button** to switch off your CD clock radio, the **On indicator** will switch off.

Important: Failure to switch off the unit will result in non operation of the alarm.

5. The CD will switch on at the preset time and play tracks in the order programmed.

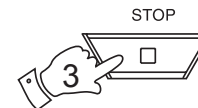

Snooze control

1. The buzzer, CD or radio alarm can be silenced for 6 minutes by pressing the **Snooze** button. This sequence can be repeated during the 90 minute alarm period.



Sleep timer

1. CD or radio playback can be set to switch off automatically after a preset time has elapsed.
2. Repeatedly press and release the **Sleep button** until the desired time is displayed (maximum 90 minutes in 30 minute steps). The **Sleep indicator** will light up and after a few seconds the radio if selected will play. If CD has been selected press **Play/Pause button** and CD will play for the selected sleep time.
3. The CD or radio will switch off after the sleep time has elapsed.
4. To cancel the sleep function before the preset time has expired, press the **On/Off button**.
5. To check remaining sleep time, press the **Sleep button** once. The remaining time will appear briefly in the display.
6. To amend the sleep time after it has been set, press the **Sleep button** repeatedly until the desired time is displayed.

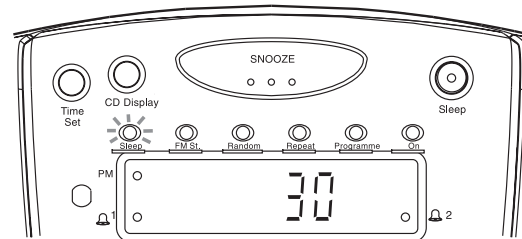
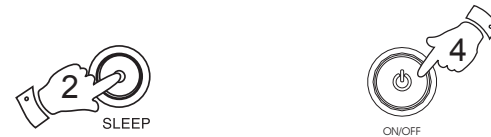

Auto Dimmer

1. The **Auto Dimmer** located on the left side of the LED Display will automatically adjust the intensity of the clock display to suit room brightness.

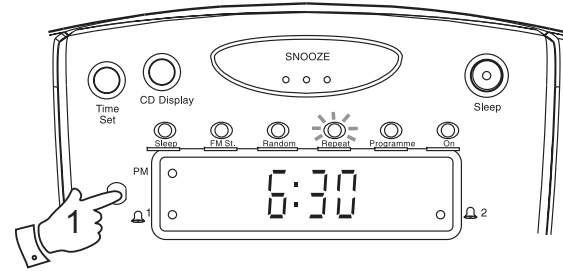

Headphones

1. A **Headphone Socket** (3.5mm) located on left side of the unit is provided for use with either headphones or an earpiece. Inserting a plug automatically mutes the internal loudspeaker.

IMPORTANT: Excessive sound pressure from earphones and headphones can cause hearing loss.

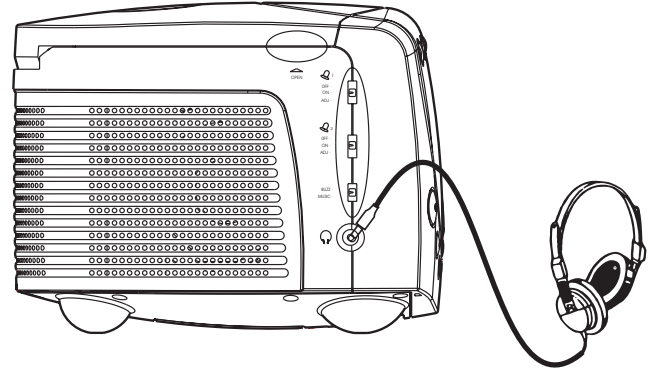

Trouble shooting

In case of malfunction due to electrostatic discharge, it may be necessary to reset the product to resume normal operation. This may generally be performed by turning the unit off and on. In some cases a more complete reset may be needed, either by removing all sources of power (battery and mains) when turned off.

Specifications

Power Requirements

Mains	AC 230 volts, 50Hz  only
Back-up Battery	IEC size 6LR61 (6F22, PP3)

Frequency Coverage

FM	87.5 - 108MHz
MW	515 - 1630kHz
LW	142 - 292kHz

Circuit Features

Loudspeaker	8 ohms
	Output power 0.8 Watts
Aerial System	FM String Wire Aerial
	MW/LW Built-in Ferrite Bar aerial

The Company reserves the right to amend the specification without notice.

**CLASS 1
LASER PRODUCT**

Warning

CLASS 1 LASER PRODUCT means that the laser's construction makes it inherently safe so that the legally prescribed maximum permissible radiation values can never be exceeded

Caution: Using any equipment or devices other than those described and specified in these operating instructions, or tampering with the unit in any way, can result in dangerous exposure to radiation.

General

Do not allow this unit to be exposed to moisture (e.g. dripping or splashing) or to temperatures exceeding 70 degrees centigrade. It is recommended that the FM band be used wherever possible as better results in terms of quality and freedom from interference will usually be obtained than on the MW/LW bands.

- No objects filled with liquids such as vases, shall be placed on the clock radio.

- It is recommended to operate the product such that there is a minimum distance (10cm recommended) to adjacent objects in order to ensure good ventilation.
- The ventilation of the product should not be restricted by covering it or its ventilation openings with items such as newspapers, tablecloths, curtains etc.
- No naked flame sources such as lighted candles should be placed on the product.
- It is recommended to avoid using or storing the product at extremes of temperature. Avoid leaving the unit in cars, on window sills in direct sunlight etc.

*If you need any further advice, please call our Technical Helpline on :-
020 8758 0338 (Mon-Fri)*

Mains supply

The CR9986 will operate from a supply of AC 230volts, 50Hz  only.

For your convenience this product is supplied with a plug which is fitted with a fuse of the appropriate rating. If the plug supplied is not suitable for your socket outlet, it should be removed by unscrewing the plug top, the terminal screws and removing the cable.

The correct style of plug to suit your household together with a correctly rated fuse should be fitted.

IF IN DOUBT - CONSULT A QUALIFIED ELECTRICIAN

IMPORTANT: DO NOT make any connection to the larger terminal which is marked with the letter E or by the safety earth symbol  or coloured Green or Green-and-yellow.

The wires in the mains lead are coloured in accordance with the following codes :-

BLUE - NEUTRAL

BROWN - LIVE

As these colours may not correspond with the coloured markings identifying the terminals in your plug, proceed as follows:-

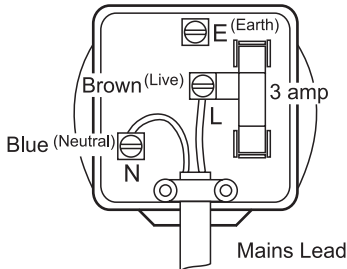

The wire coloured BLUE must be connected to the terminal marked N or coloured BLACK.

The wire coloured BROWN must be connected to the terminal marked L or coloured RED.

Fuse

This apparatus must be protected by a 3A fuse (BS1362) in a 13A plug (BS1363). If another type of plug is used a 5A fuse should be fitted in the plug, adaptor or distribution board.

IF IN DOUBT - CONSULT A QUALIFIED ELECTRICIAN.

Back-up Battery (not necessary for the unit to function)

Slide the battery cover catch in the direction of the arrow. Open the battery cover. Fit a 9 volt IEC size 6LR61 (6F22, PP3) or equivalent battery into the compartment. Observe the correct polarity as shown inside the battery compartment. Replace the battery cover.

The time and alarm settings will be retained during a temporary failure of the AC mains supply. The LED display will not be operational. The display will be extinguished to conserve battery life, but the memory will retain details of the time and alarm time settings.

If your clock radio is not to be used for a prolonged period of time, remove the battery to avoid damage by battery leakage.

IMPORTANT: *The batteries should not be exposed to excessive heat such as sunshine, fire or the like. After use, disposable batteries should if possible be taken to a suitable recycling centre. On no account should batteries be disposed of by incineration.*

The Nameplate is located on the underside of your CD clock radio.

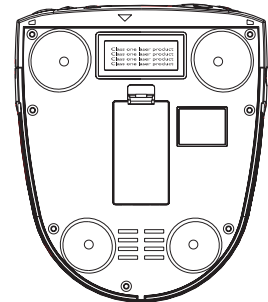

Guarantee

This instrument is guaranteed for twelve months from the date of delivery to the original owner against failure due to faulty workmanship or component breakdown, subject to the procedure stated below. Should any component or part fail during this guarantee period it will be repaired or replaced free of charge.

The guarantee does not cover:

1. Damage resulting from incorrect use.
2. Consequential damage.
3. Receivers with removed or defaced serial numbers.

Procedure:

Any claim under this guarantee should be made through the dealer from whom the instrument was purchased. It is likely that your Roberts' dealer will be able to attend to any defect quickly and efficiently, but should it be necessary the dealer will return the instrument to the company's service department for attention. In the event that it is not possible to return the instrument to the Roberts' dealer from whom it was purchased, please contact Roberts Radio Technical Services department at the address shown on the rear of this manual before taking further action.

These statements do not affect the statutory rights of a consumer.

*If you need any further advice, please call our Technical Helpline on :-
020 8758 0338 (Mon-Fri)*



Issue 2

ROBERTS RADIO TECHNICAL SERVICES

97-99 Worton Road
Isleworth Middlesex
TW7 6EG

Technical Helpline:- 020 8758 0338 (*Mon-Fri*)

Website: <http://www.robertsradio.co.uk>

