

ROBERTS

Blutune 200

DAB/DAB+/FM/CD/SD/USB/Bluetooth Sound System



DAB
Digital Audio Broadcasting



**Digital
Radio**

Please read this manual before use

Contents

Introduction	2-9	MP3/WMA CD mode	34
<i>Blutune 200 Sound System features</i>	3	<i>MP3/WMA file and folder selection</i>	35-36
<i>Controls and connections</i>	4-5	SD/USB playback and recording	37-44
<i>Remote control</i>	6-7	<i>Using SD cards and USB memory devices</i>	37
<i>Display icons</i>	8	<i>SD/USB file and folder selection</i>	38-39
<i>Accessing the menu system</i>	8	<i>Recording to SD/USB</i>	40-42
<i>Using the sound system for the first time</i>	9	<i>Deleting and formatting</i>	43-44
DAB radio	10-16	Clock and Alarms	45-51
<i>Operating your sound system - DAB</i>	10	<i>Alarms</i>	45-47
<i>Selecting a station - DAB</i>	11	<i>Cancelling alarms</i>	47
<i>Secondary services - DAB</i>	11	<i>Snooze function</i>	48
<i>Display options - DAB</i>	12-13	<i>Viewing the alarm settings</i>	48
<i>Finding new stations - DAB</i>	13	<i>Sleep function</i>	49
<i>Manual tuning - DAB</i>	14	<i>Setting the clock manually</i>	50-51
<i>Dynamic range control - DAB</i>	15	<i>To return to auto clock set mode</i>	51
<i>Station order setup - DAB</i>	16	Audio and Setup	52-59
FM radio	17-24	<i>Equalizer function</i>	52
<i>Operating your radio - search tuning FM</i>	17	<i>Treble and Bass settings</i>	53
<i>Manual tuning - FM</i>	18	<i>Mute function</i>	54
<i>Display options - FM</i>	19	<i>Auxiliary input socket</i>	55
<i>FM stereo/mono - FM</i>	20	<i>Headphone socket</i>	55
<i>Scan sensitivity setting - FM</i>	21	<i>Standby brightness control</i>	56
<i>Presetting stations - DAB and FM</i>	22-23	<i>System reset</i>	57
<i>Language function - DAB and FM</i>	24	<i>Software version displays</i>	58
Bluetooth mode	25-28	<i>Aerial removal</i>	59
<i>Connecting Bluetooth devices</i>	26	<i>USB socket for smart phone charging</i>	59
<i>Playing audio files in Bluetooth mode</i>	27	<i>USB socket for software upgrades</i>	59
<i>Connecting and reconnecting a Bluetooth device</i>	28	Information	60-62
CD/MP3/WMA	29-36	<i>Cautions</i>	60
<i>Compact discs</i>	29	<i>Specifications</i>	60
<i>Playing a CD</i>	30-31	<i>Mains supply</i>	61
<i>Repeat and shuffle options</i>	32-33	<i>Guarantee</i>	62

About this instruction manual

This instruction manual is split into sections for each of the different operating modes of your Roberts Blutune 200 Digital Sound System. The introduction describes the features and controls of the product.

There are seven sections covering the main features in detail - DAB radio, FM radio, Bluetooth, CD/MP3/WMA playback, SD card/USB device, Clock and Alarm, and Audio and Setup. Each section is clearly identified by the shaded heading in the top right hand corner of each pair of pages.

The two sections for **DAB Radio** and **FM Radio** describe how to use the sound system to listen to radio broadcasts.

The section for **Bluetooth** describes how to use your Blutune 200 to play audio files or video soundtracks directly from your smart-phone, tablet or similar devices.

The section for **CD/MP3/WMA player** describes how to play digital audio CDs or MP3/WMA files which have previously been recorded to CD-R or CD-RW.

The section for **SD/USB media** describes playback and record using SD card and USB memory devices.

The section titled **Clock** and **Alarms** describes setting the clock, as well as explaining the use of the alarms, snooze and sleep timer features.

The **Audio** and **Setup** section describes how to use the audio equalizer and tone controls and how to connect other audio equipment. The brightness adjustment and system reset procedure is also described.

Lastly, the **Information** section includes safety, specifications and warranty information.

Introduction

Introduction

(page 2)

DAB Radio

(page 10)

FM Radio

(page 17)

Bluetooth

(page 25)

CD/MP3/WMA

(page 29)

SD/USB media

(page 37)

Clock and Alarms

(page 45)

Audio and Setup

(page 52)

Information

(page 60)

Blutune 200 Sound System features

The Roberts Blutune 200 Sound System provides the following range of features in an attractive compact unit:-

- Radio for DAB and FM (with RDS) broadcasts.
- 20 radio station presets (10 for DAB and 10 for FM).
- Bluetooth streaming to play your music or video soundtracks from your smart-phone, tablet or similar device.
- Audio CD player with track search and repeat and shuffle facility (can also play CD-R, CD-RW discs). *
- Playback of MP3 and WMA files which have been recorded to CD-R or CD-RW.
- Playback of MP3 and WMA files which have been recorded to SD card and USB memory devices.
- Record from the radio, CD or auxiliary input to SD card or USB memory devices.
- Record MP3/WMA files from CD/SD/USB card to SD/USB.
- USB socket may also be used for charging smart-phones or tablets.
- Clock display with time and date when in standby.
- Two alarm timers with snooze feature to wake you to either buzzer, radio, CD, SD card or USB memory device (with humane wake system on buzzer alarm).
- Adjustable sleep timer which can be set to turn the sound system off after between 15 and 120 minutes.
- Easy-to-read 2 line text display with large clock display.
- A 3.5mm stereo Auxiliary Input socket for playing audio from iPods, MP3 players and other devices.
- A standard 3.5mm headphone socket for private listening.
- High quality, full range, stereo speakers (2 x 8W).
- An acoustically tuned, hand finished cabinet that includes bass ports and internal bracing for optimal sound reproduction.
- Low power consumption when in standby mode.

Note:

- * 8cm (mini) CDs cannot be played. Transparent or partly transparent CDs cannot be played. Unusually thin (Eco) CDs cannot be played. Some copy-protected CDs may not be playable.

(Top)

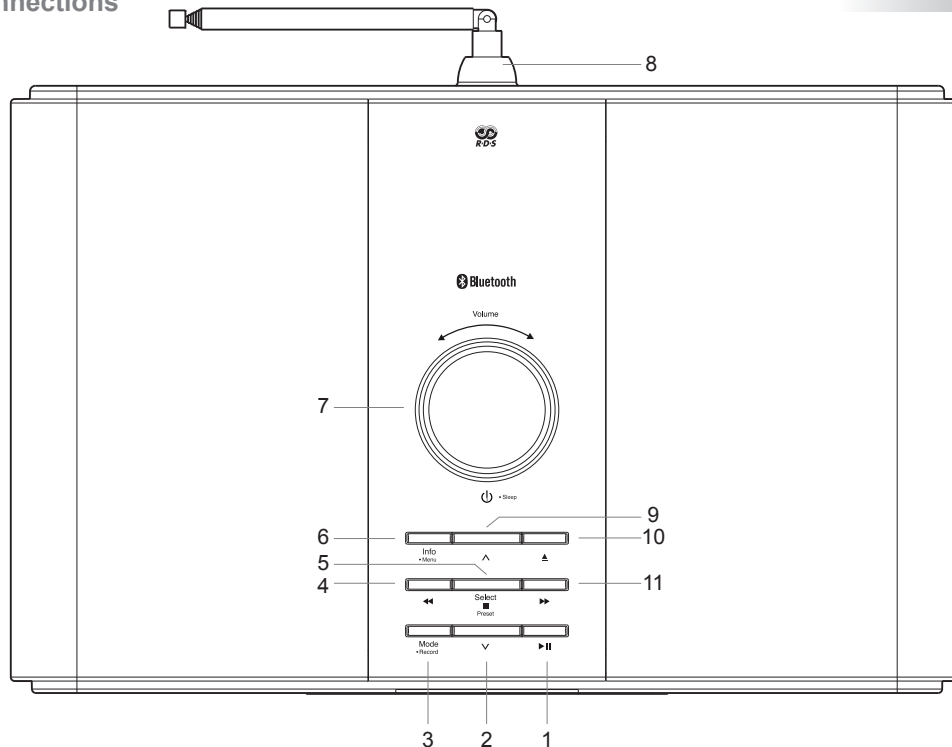

- 1. Play / Pause button
- 2. Folder Down button
- 3. Mode / Record button
- 4. Tuning Down / Rewind button

- 5. Select / Preset / Stop button
- 6. Info / Menu button
- 7. On / Standby / Volume control
- 8. Telescopic aerial

- 9. Folder Up button
- 10. CD eject button
- 11. Tuning Up / Fast-forward button

Controls and connections

(Front)

- 12. Standby indicator
- 13. Bluetooth indicator
- 14. LCD display
- 15. Infra-red sensor
- 16. CD loaded indicator
- 17. CD slot

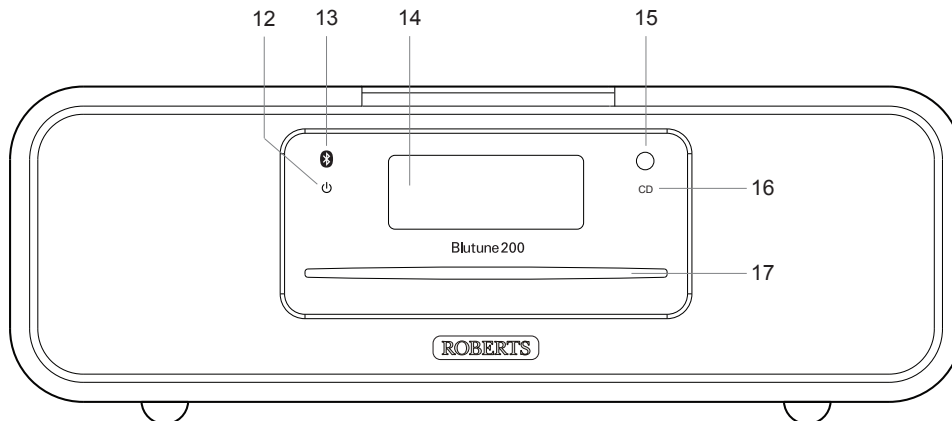

(Rear)

- 18. Telescopic aerial
- 19. Mains input socket
- 20. Headphone socket
- 21. Auxiliary input socket
- 22. USB socket (for software upgrades only)
- 23. USB socket (play, record, charge)
- 24. SD/SDHC card slot

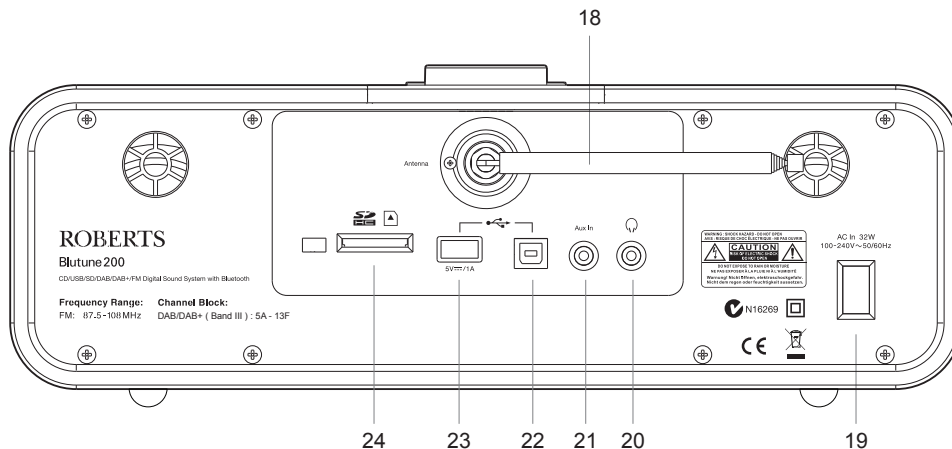

Remote control

All the functions of the Blutune 200 Sound System can be controlled using either the sound system buttons or the remote control with the exception of the CD Eject function. The CD Eject function can only be controlled using the CD Eject button on the sound system.

1. On / Standby / Sleep button
2. Mode / Record button
3. Info / Menu button
4. Tuning Down / Rewind button
5. Folder Up button
6. Tuning Up / Fast-forward button
7. Play / Pause button
8. Volume Down button
9. Volume Up button
10. Select / Preset button
11. Folder Down button

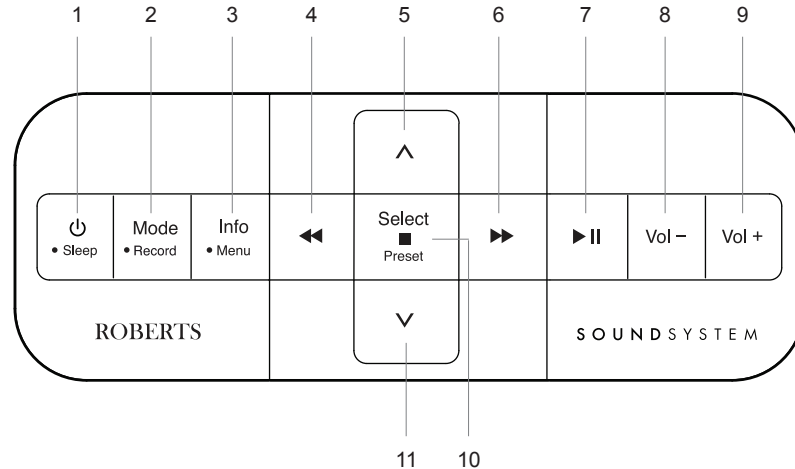

Remote control battery replacement

1. Remove the battery cover on the rear of your remote control by applying pressure to the catch in the direction shown by the arrow and then lifting off the cover.
2. Remove the battery from the battery compartment by pressing the right hand bottom corner of the battery so that the battery is released from its position (see illustration). The battery can now be lifted out.
3. Replace the battery (CR2032 or equivalent) ensuring that the positive side of the battery remains visible as the battery is inserted. Place the battery under the lip in the bottom right hand corner then click into place.
4. Close the battery cover by inserting the retaining lug first, then apply pressure to the free end such that the catch latches the cover securely.
5. If the remote is not to be used for an extended period of time it is recommended that the batteries are removed.

IMPORTANT: The batteries should not be exposed to excessive heat such as sunshine, fire or the like. After use, disposable batteries should if possible be taken to a suitable recycling centre. On no account should batteries be disposed of by incineration.



WARNING:

- Do not ingest the battery. Chemical Burn hazard.
- The remote control supplied with this product contains a coin/button cell battery. If the coin/button cell battery is swallowed it can cause severe internal burns in just 2 hours and can be fatal.
- Keep new and used batteries away from children. They can be a choking hazard.
- If the battery compartment does not close securely, stop using the product and keep it away from children.
- If you think batteries might have been swallowed or placed inside any part of the body, seek immediate medical attention.

CAUTION

Danger of explosion if the battery is incorrectly replaced. Replace only with the same or equivalent type.

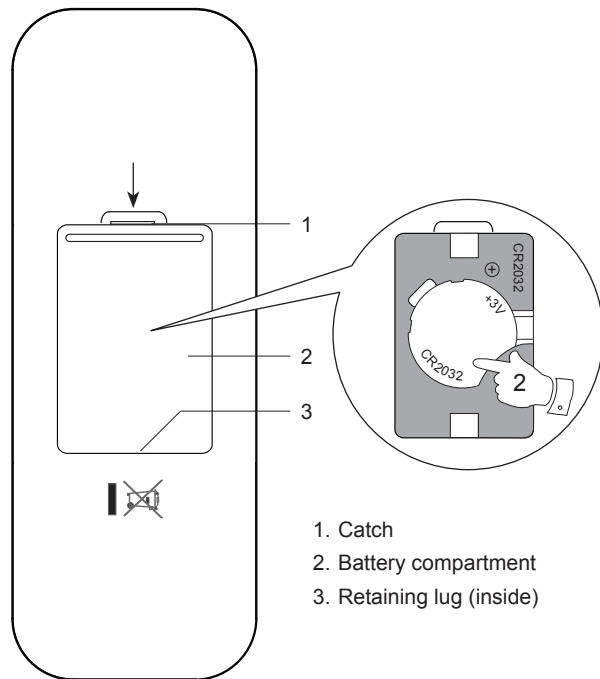

Display icons

- | | |
|------------------------------------|----------------------------------|
| A. Sleep indicator | I. Stereo indicator |
| B. Alarm 1 and 2 indicators | J. Aux input indicator |
| C. Snooze indicator | K. Repeat single track indicator |
| D. Radio signal strength indicator | L. Repeat all indicator |
| E. Clock digits | M. Repeat indicator |
| F. Bluetooth indicator | N. Repeat folder indicator |
| G. DAB indicator | O. CD, SD, USB indicators |
| H. FM indicator | P. Two line text display |

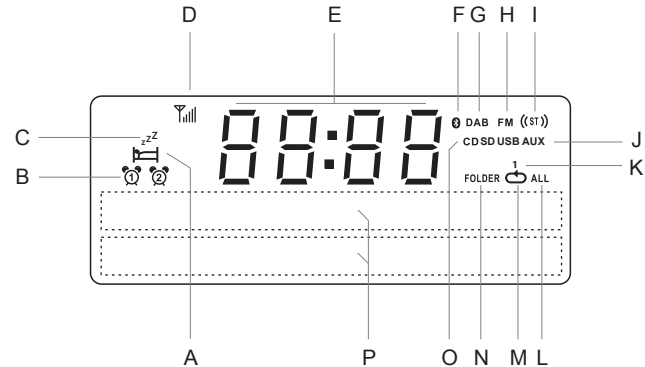

On / Standby / Volume control

Your sound system has a top control that has the following functions.

1. Momentarily **press and release** the control to switch your sound system on or into standby mode.
2. **Rotate** the control clockwise to increase the volume and anti-clockwise to decrease the volume level.
3. When the sound system is playing **press and hold** the control to access the sleep menu.

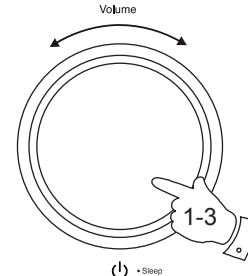

Accessing the menu system

1. To access the menu system, press and hold the **Menu** button.
2. To exit the menu system, press and release the **Menu** button as needed.

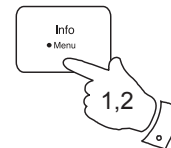

Using the sound system for the first time

1. Place your sound system on a flat surface.
2. Fully extend the telescopic aerial. The aerial should be fully extended and positioned vertically for optimum reception.
3. Plug the mains lead into the mains socket located on the back of your sound system ensuring that the plug is pushed fully into the socket.
4. Plug the other end of the mains lead into the wall socket and switch on the wall socket.

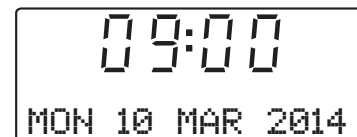
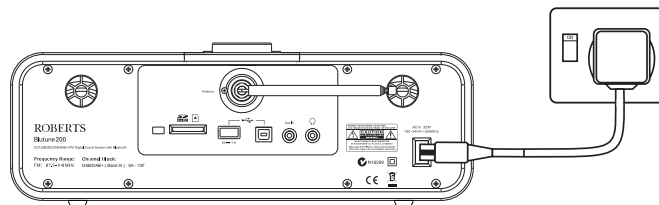

- IMPORTANT:** The mains plug is used as the means of connecting the sound system to the mains supply. The mains socket used for the sound system must remain accessible during normal use. In order to disconnect the sound system from the mains completely, the mains plug should be removed from the mains socket outlet completely.
5. When your sound system is first switched on the clock display will show 12:00 and the unit will enter standby mode. It will then scan for DAB radio stations and when stations have been found the clock and date should be set automatically. Note that the display will not show any scanning message for this first scan.
 6. If no stations have been found then the clock will not set. You may need to relocate your sound system to a position giving better reception. You should then carry out an auto-tune to find DAB stations. See DAB Operation on page 10 and also Finding New Stations on page 13. The clock will then be set from a DAB broadcast.

Operating your sound system - DAB

1. Fully extend the telescopic aerial.
2. If your sound system is in standby mode, press and release the **On / Standby** button to switch it on.
3. Press and release the **Mode** button until the DAB mode is selected. The display will show 'DAB' for a few seconds.
4. If this is the first time the sound system is used a scan of Band III DAB channels may be carried out (depending on whether scanning was already completed in standby mode). If the radio has been used before, the last used station will be selected.
5. When first switched on, the first station in the list of stations found will be played. The display will show the station name on the upper line of the text display and broadcast information on the lower line.
6. If the station list is still empty after the scan operation or if the selected station cannot be received your radio will display 'No DAB station'.
7. If no signals are found it may be necessary to relocate your sound system to a position giving better reception, and then repeat the scan using the Auto-tune facility (see Finding New Stations on page 13).

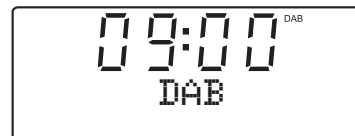
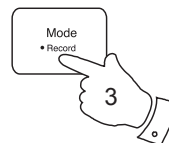

Note: that radio station name and frequency displays shown in this user guide may differ from those that you see on your radio. Broadcasters may change radio station names that are transmitted, and the frequencies used for DAB and FM radio stations may not be the same in all parts of the country.

Selecting a station - DAB

1. When the unit is in DAB mode the upper line of the text display normally shows the name of the station currently tuned.
2. Repeatedly press the **Tuning Up** or **Down** buttons to scroll through the list of available stations on the lower line of the text display. Stop pressing the **Tuning** buttons when you find the station that you wish to hear. If you keep pressing one of the tuning buttons then the unit will rapidly scroll through the list of available stations.

3. Press and release the **Select** button to cause the radio to tune to the chosen station. The display may show 'Connecting' while your radio finds the new station.

The use of memory presets is described on page 22.

4. Adjust the **Volume** to the required setting.

If after selecting a station the display shows 'No DAB Station' it may be necessary to relocate your radio to a position giving better reception.

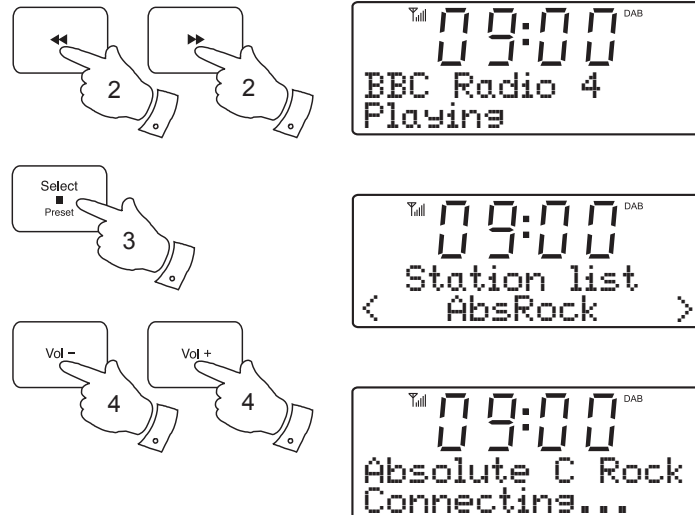

Secondary services - DAB

1. Certain radio stations have one or more secondary services associated with them. If a station has a secondary service associated with it the display will show '>>' next to the station name on the station list. The secondary service will then appear immediately after the primary service as you press the **Tuning Up** button.
2. Press and release the **Select** button to select the station.

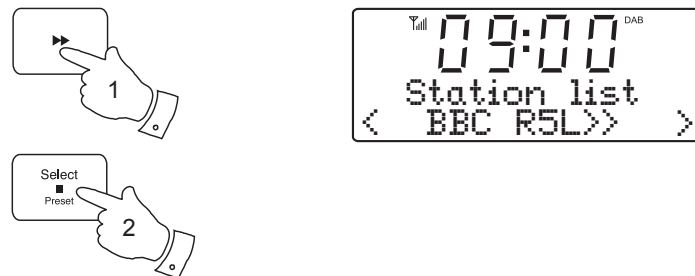

Display options - DAB

When in DAB mode your radio has a range of display options.

1. Press and release the **Info** button to cycle through the various options.

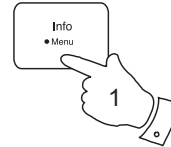

- a. Scrolling text Displays scrolling text messages such as artist/track name, phone in number, etc.
- b. Programme type Displays the type of station being listened to e.g. Pop, Classic, News, etc.
- c. Multiplex Name Displays the name of the DAB multiplex to which the current station belongs.
- d. Date Displays the current date.
- e. Channel & frequency Displays the channel number and frequency for the current DAB radio station.



Display options - DAB cont.

- f. Bit rate/audio type Displays the digital bit rate and audio type for the current DAB radio station.
- g. Signal strength Displays signal strength for the station being listened to. The clear rectangle shows the minimum required signal strength for clear DAB reception.



Finding new stations - DAB

As time passes new stations may become available. To find new stations proceed as follows:-

1. Press and hold the **Menu** button. 'DAB Menu' will appear on the display.
2. Press and release the **Select** button to enter the DAB menu.
3. Press the **Tuning Up** or **Down** buttons until 'Scan' appears on the display.
4. Press and release the **Select** button. The display will then show 'Scanning...' and your sound system will perform a scan of the Band III DAB channels. As new stations are found the station counter on the right-hand side of the display will increase and any new stations will be added to the list stored in the sound system.

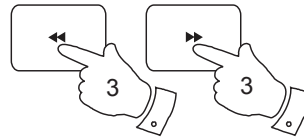
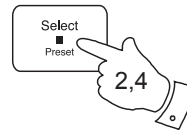
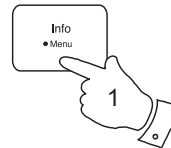

Manual Tuning - DAB

Manual tuning allows you to tune your radio to a particular DAB frequency in Band III. Any new stations found will be added to the station list. This function can also be used to assist the positioning of the aerial or sound system to optimise reception for a specific channel or frequency. At the time of writing this instruction book, UK DAB stations are located in the range of channels 10C to 12D.

1. Press and hold the **Menu** button. 'DAB Menu' will appear on the display.
2. Press and release the **Select** button to enter the DAB menu.
3. Press the **Tuning Up** or **Down** buttons until 'Manual tune' appears on the display. Press and release the **Select** button.
4. Press the **Tuning Up** or **Down** buttons to select the desired DAB channel.
5. Press and release the **Select** button. The open block in the signal strength graph shows the minimum signal strength needed for good DAB reception. The signal blocks will go up and down showing the changing signal strength as you adjust the telescopic aerial or the sound system position. Any new radio stations found on the tuned DAB multiplex will be added to the list stored in the radio.
6. Any new stations that are found are automatically added to the stored list of stations.
7. Press and release the **Select** button to return to normal tuning mode.

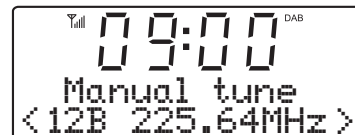
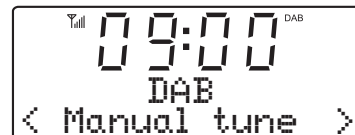
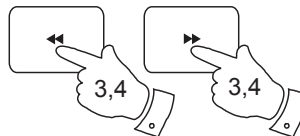
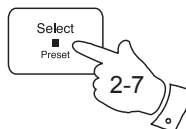
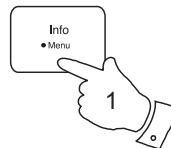

Dynamic Range Control (DRC) settings - DAB

Dynamic range control (also known as DRC) can make quieter sounds easier to hear when your sound system is used in a noisy environment.

There are 3 levels of compression:

DRC Off - No compression applied. (default)

DRC High - Maximum compression applied.

DRC Low - Medium compression applied.

1. Press and release the **On / Standby** button to switch on your sound system. Press and release the **Mode** button until the DAB mode is selected.
2. Press and hold the **Menu** button. 'DAB Menu' will appear on the display. Press and release the **Select** button to enter the DAB menu.
3. Press the **Tuning Up** or **Down** buttons until the display shows 'DRC'.
4. Press and release the **Select** button to enter the DRC adjustment menu.
5. Press the **Tuning Up** or **Down** buttons to select the required DRC setting (the default is Off). The chosen DRC setting will be marked with an asterisk.
6. Press and release the **Select** button to confirm the setting.

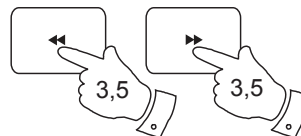
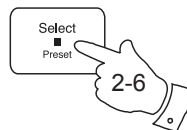
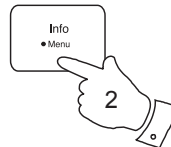
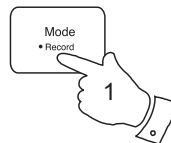

Note: Not all DAB broadcasts are able to use the DRC function. If the broadcast does not support DRC, then the DRC setting in the radio will have no effect.

Station order setup - DAB

Your sound system has 2 station order settings from which you can choose. The station order settings are, alphanumeric and ensemble.

Note: The default station order setting is alphanumeric.

1. Press and release the **On / Standby** button to switch on your sound system. Press and release the **Mode** button until the DAB mode is selected.
2. Press and hold the **Menu** button. 'DAB Menu' will appear on the display. Press and release the **Select** button to enter the DAB menu.
3. Press the **Tuning Up** or **Down** buttons until 'Station order' appears on the display. Press and release the **Select** button to enter the station order selection menu.
4. Press the **Tuning Up** or **Down** buttons to choose between alphanumeric or ensemble. The chosen station order setting will be marked with an asterisk.
'Alphanumeric' - sorts the station list alpha-numerically 0...9 A...Z.
'Ensemble' - organises the station list by DAB multiplex.
 Most users will find it best to leave the station order set to Alphanumeric.
5. Press and release the **Select** button to select the required station order.

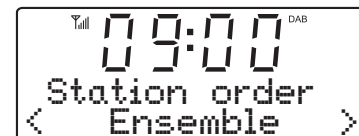
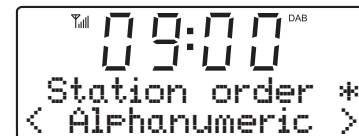
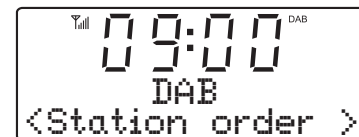
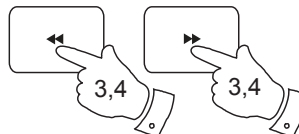
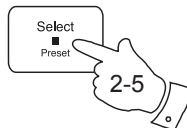
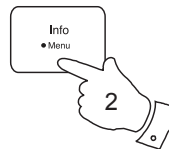
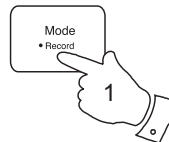

Operating your radio - Search tuning FM

1. Fully extend the telescopic aerial. The aerial should be fully extended and positioned vertically for optimum reception.
2. Press and release the **On / Standby** button to switch on your sound system.
3. Press and release the **Mode** button until the FM band is selected.
4. Press and hold down the **Tuning Up** button for 2 - 3 seconds to cause your radio to search from low frequency to high frequency and to stop automatically when it finds a station of sufficient strength.
5. After a few seconds the display will update. The display will show the frequency of the signal found. If the signal is strong enough and there is RDS data present then the radio will display the station name.
6. To find other stations press and hold the **Tuning Up** button as before.
7. Press and hold down the **Tuning Down** button for 2 - 3 seconds to cause your radio to search from high frequency to low frequency and to stop automatically when it finds a station of sufficient strength.
8. When the end of the waveband is reached your radio will recommence tuning from the opposite end of the waveband.
9. Adjust the **Volume** to the required setting.
10. To switch off your radio press and release the **On / Standby** button.

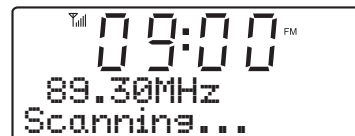
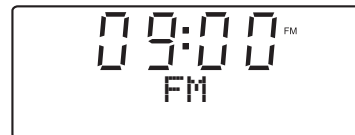
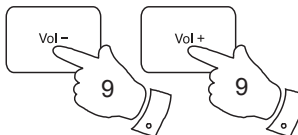
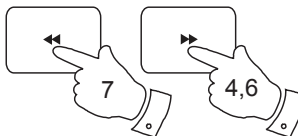
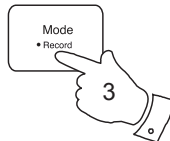
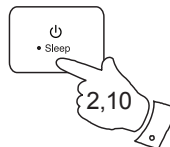

Note:

If you find that FM reception is poor, try repositioning the telescopic aerial. Fully extend and position vertically for optimum reception. If you find that an FM broadcast has a lot of background hiss, this may often be reduced by setting the radio into Mono reception mode for the current FM station. Please refer to the section 'Stereo / Mono setting - FM' on page 20 for further details.

Manual tuning - FM

1. Fully extend the telescopic aerial. The aerial should be fully extended and positioned vertically for optimum reception.
2. Press and release the **On / Standby** button to switch on your sound system.
3. Press and release the **Mode** button until the FM band is selected.
4. Repeatedly press and release the **Tuning Up** or **Down** buttons to tune to a station. The frequency will change in steps of 50kHz.
If the radio is tuned to a station of sufficient signal strength with RDS information present, then the display may change to show the station name.
5. When the end of the waveband is reached the radio will recommence tuning from the opposite end.
6. Set the **Volume** to the desired setting.
7. To switch off your sound system press and release the **On / Standby** button.

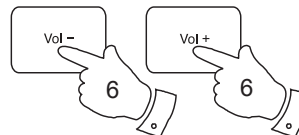
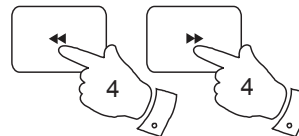
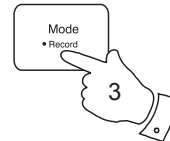
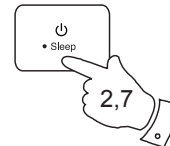

Note:

If you find that FM reception is poor, try repositioning the telescopic aerial. Fully extend and position vertically for optimum reception. If you find that an FM broadcast has a lot of background hiss, this may often be reduced by setting the radio into Mono reception mode for the current FM station. Please refer to the section 'Stereo / Mono setting - FM' on page 20 for further details.

Display options - FM

Your sound system has a range of display options for FM mode:-

The Radio Data System (RDS) is a system in which inaudible digital information is transmitted in addition to the normal FM radio programme. RDS offers several useful features. The following are available on your sound system.

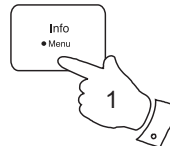

1. Press and release the **Info** button to cycle through the various modes.

- | | |
|-------------------|---|
| a. Radio text | Displays scrolling text messages such as artist / track name, phone in number, etc. |
| b. Programme Type | Displays the type of station being listened to e.g. Pop, Classic, News, etc. |
| c. Date | Displays the current date. |
| d. Station name | Displays the name of the station being listened to. |

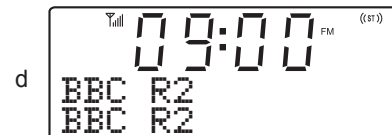
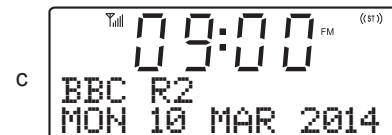
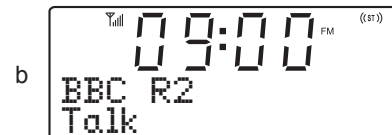

Note: If no RDS information is available, the radio will be unable to display the station name, radio text and programme type information. If the signal is too weak then the radio will display only the FM frequency and the optional Stereo indicator.

Stereo/Mono setting - FM

Your sound system will play stereo FM broadcasts in stereo provided that the received signal is of adequate strength. However, as a stereo signal becomes weaker the audio signal will become poorer. It may be preferable to force the radio to play the station in mono in order to reduce the level of background hiss.

1. Press and release the **On / Standby** button to switch on your sound system.
2. Tune to the required FM radio station as previously described (see pages 17, 18).
3. Press and hold the **Menu** button. 'FM Menu' will appear on the display. Press and release the **Select** button to enter the FM menu.
4. Press the **Tuning Up** or **Down** buttons until 'Audio setting' appears on the display. Press and release the **Select** button.
5. To switch to mono to reduce the hiss from a weak FM signal press the **Tuning Up** or **Down** buttons until 'Forced mono' appears on the display. Press and release the **Select** button to confirm the setting.

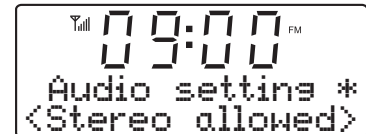
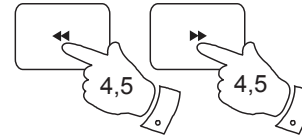
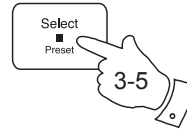
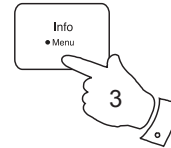

Alternatively, to return to normal automatic 'stereo or mono' press the **Tuning Up** or **Down** buttons until 'Stereo allowed' appears on the display. Press and release the **Select** button to confirm the setting.

Scan sensitivity setting - FM

Your sound system will normally scan for FM broadcasts which are strong enough to give good reception. However, you may wish the Auto-scan function to also be able to find weaker signals, possibly from more distant radio transmitters. Your radio includes a local / distant option for the Auto-scan function.

1. Press and release the **On / Standby** button to switch on your sound system.
2. If needed, press and release the **Mode** button until the FM band is selected.
3. Press and hold the **Menu** button. 'FM Menu' will appear on the display. Press and release the **Select** button to enter the FM menu.
4. Press the **Tuning Up** or **Down** buttons until 'Scan setting' shows on the display. Press and release the **Select** button to enter the scan sensitivity adjustment mode.
5. Press the **Tuning Up** or **Down** buttons to switch between Local ('Strong stations only') and Distant ('All stations') options on the lower line of the display. The Distant option will allow the radio to find weaker signals when scanning.
6. Press and release the **Select** button to confirm your selection. The Local or Distant setting is stored in the radio and remains in force until changed or until a System Reset.

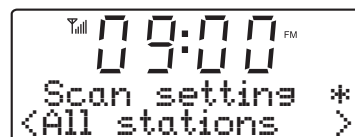
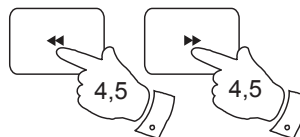
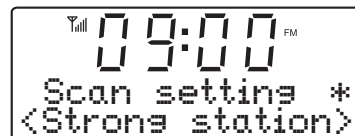
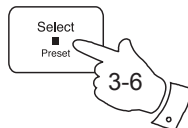
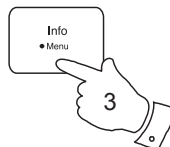
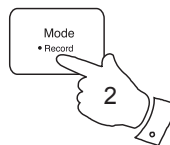

Note: The initial setting (out of the box, or after a System Reset) causes the radio to ignore weaker (or more distant) signals.

Presetting stations - DAB and FM

You may store your preferred DAB and FM radio stations to the preset station memories. There are 20 memory presets in your radio, 10 for DAB and 10 for FM. Presets are remembered by your radio in the event of a power failure.

The procedure for setting presets and using them to tune stations is the same for FM and DAB modes, and is described below.

1. Press and release the **On / Standby** button to switch on the sound system.
2. Press and release the **Mode** button to select the desired waveband DAB or FM.
3. Tune to the required station as previously described.
4. Press and hold the **Preset** button. The display will show, for example, '1: (Empty)' if no station has been stored to that preset.
5. Use the **Tuning Up** or **Down** buttons to select the desired preset station number under which you wish to store the station.
6. Press and release the **Preset** button until the display shows, for example, 'Preset 1 stored'. The station will be stored under the chosen preset. Repeat this procedure for the remaining presets.
7. Stations which have been stored in preset memories may be overwritten by following the above procedure.

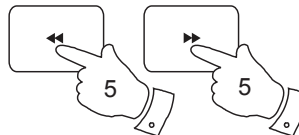
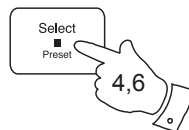
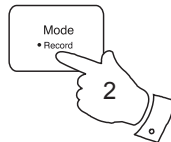
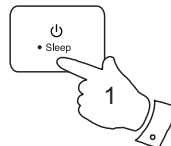

Recalling a preset station

1. Press and release the **On / Standby** button to switch on the sound system.
2. Press and release the **Mode** button to select the desired waveband DAB or FM.
3. Press and release the **Preset** button. The display will show, for example, '1: (Empty)' if no station has been stored to that preset. If a preset has been stored, then the display will show either the station name (for DAB stations) or the frequency (for FM stations).
4. Press the **Tuning Up** or **Down** buttons to select the desired preset station.
5. Press and release the **Select** button. Your radio will tune to the chosen preset station stored in the preset memory.

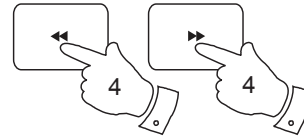
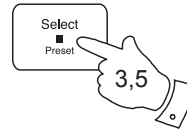
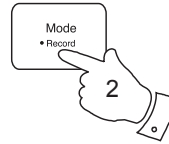

Language function - DAB and FM

If required, your sound system's radio functions can be configured to a different language.

1. Press and release the **On / Standby** button to switch on your sound system.
2. If needed, press and release the **Mode** button to select the DAB or FM band.
3. Press and hold the **Menu** button. 'DAB or FM Menu' will appear on the display. Press and release the **Select** button to enter the menu.
4. Press the **Tuning Up** or **Down** buttons until 'Language' shows on the display. Press and release the **Select** button to enter the language adjustment menu.
5. Press the **Tuning Up** or **Down** buttons until your desired language appears on the display. The current language setting will be marked with an asterisk.
6. Press and release the **Select** button to confirm your choice. The display will change to the chosen language when using DAB or FM mode.

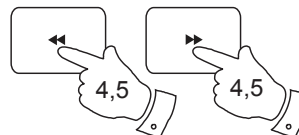
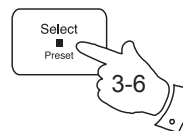
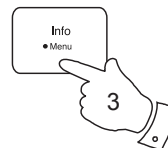
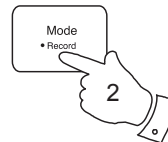
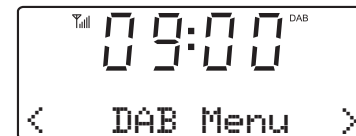
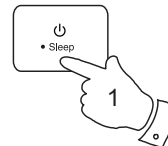

Bluetooth mode

The Bluetooth mode on your sound system allows you to play audio, play sound from video files and stream music from Bluetooth capable devices such as your mobile phone, computer, tablet etc. through your sound system's loudspeakers.

- When a Bluetooth enabled device such as your Blutune 200 sound system is in a 'discoverable' state other Bluetooth devices can detect, pair with or connect to it.
- 'Bluetooth pairing' occurs when two Bluetooth enabled devices agree to establish a connection and communicate with each other.
- ***Your sound system will flash the Bluetooth indicator light on the front panel when it is discoverable or when it is trying to connect to a previously paired Bluetooth device. When a device is paired with and connects to your sound system, the Bluetooth indicator light on the sound system will remain lit.***

Bluetooth connectivity performance may vary depending on the connected Bluetooth devices. Please refer to the Bluetooth capabilities of your device before connecting to your sound system. All features may not be supported on some paired Bluetooth devices.

A Bluetooth connection can provide a link for audio up to a distance of approximately ten metres. When pairing two Bluetooth enabled devices, for convenience, we recommend they should be no more than 2 to 3 metres apart. The presence of other functioning Bluetooth devices during connection may lead to operational difficulties.

Bluetooth is a short-range radio communication system and generally Bluetooth devices can communicate with each other clearly within a regular sized room or office. The reliability of a Bluetooth connection between different rooms will greatly depend upon the construction of the building.

Bluetooth communication range may be substantially reduced if the signal passes through a solid object. Human bodies, brick and concrete walls, heavy furniture or bookcases will all reduce the operational range of your Bluetooth devices to a greater or lesser extent. Glass, dry-wall or wood paneled walls and office partitions may have a less severe but noticeable effect. Metal pipes, foil-lined plasterboard, metal window frames and domestic wiring can also have an effect. You should position your Bluetooth devices closer to each other if you observe communication difficulties.

WiFi networks and cordless phones generally use similar radio frequencies to Bluetooth and may interfere with one another. If any interference is noticed, then try relocating the sound system or one of the other devices.

The Bluetooth capabilities of your sound system enable it to receive audio from many Bluetooth capable devices including mobile phones, personal computers and tablets. Only one Bluetooth device can be connected to your sound system at a time. It supports the following Bluetooth profiles and functionality.

- Your sound system supports A2DP (Advanced Audio Distribution Profile) which is a stereo audio connection that streams stereo music from PCs, mobile phones etc. SBC and AAC audio codecs are supported.
- Your sound system supports AVRCP (Audio Video Remote Control Profile) which allows your radio to control music playback from the connected device.

Note: Some mobile phones may temporarily disconnect from your sound system when you make or receive calls. Some devices may temporarily mute their Bluetooth audio streaming when they receive text messages, emails or for other reasons unrelated to audio streaming. Such behaviour is a function of the connected device and does not indicate a fault with your sound system.

Connecting Bluetooth devices

1. Ensure that the Bluetooth capability on your phone, tablet or PC is enabled. You may need to refer to the user documentation for your device, since the method will vary with each device.
2. Press and release the **On/Standby** button to switch on the sound system.
3. Repeatedly, press and release the **Mode** button on your sound system until the Bluetooth mode is selected. Your sound system will show that it is 'discoverable' by flashing the **Bluetooth indicator** (on the front panel, not the one on the display) and showing 'Bluetooth Pairing...' on the display.
4. Using the Bluetooth settings of your phone, tablet or PC direct it to search for 'discoverable' devices. After a few seconds, you should see a device named '*Blutune 200*'. Just occasionally it may take longer for the sound system to be found by your device.
5. Select '*Blutune 200*' to cause your phone, tablet or PC to pair with your sound system and to establish a connection.
6. Once the connection is established, the **Bluetooth indicator** on the front panel will stop flashing and will remain lit. A message will be displayed briefly confirming the name of the connected device.

You can now begin playing music from your smart-phone, tablet, etc.

Some Bluetooth devices may require a 'Passkey' (an authentication key) in order to establish a link between devices. A passkey is similar to a password, although you only need to use the passkey once to establish a link. If your device asks for a passkey to be able to pair with your radio then enter a code of 0000 (four zeroes).

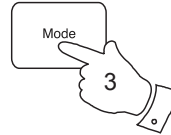

Playing audio files in Bluetooth mode

When you have successfully connected your sound system with your chosen Bluetooth device you can start to play your music using the controls on the device.

1. Once playing has started adjust the volume to the required setting using the **Volume** buttons on your sound system or the connected Bluetooth device.
2. Provided that your phone, tablet or PC allows volume control when using Bluetooth we recommend that for normal Bluetooth listening the sound system's volume control is set to a high level. This will permit the audio volume to be controlled using the connected Bluetooth device. This will generally be the more convenient method of controlling the volume.

However, if you are using headphones plugged into your sound system, we strongly recommend that the sound system's volume control is used as the means of adjusting the audio volume. You will then need to set the volume on the connected Bluetooth device to a higher level. The purpose here is to prevent unexpectedly loud noises in the headphones, when changing audio sources in the sound system or when switching on and off.

3. The audio player in your phone, tablet or PC may be able to respond to the **Play/Pause**, **Next** track and **Previous** track buttons on the sound system.

Note: That not all player applications or devices may respond to all of these buttons.

4. If your connected device is able to provide information from the track being played, you may press and release the **Info** button to display the Title, Album and Artist details on the display.

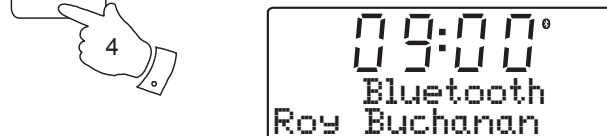
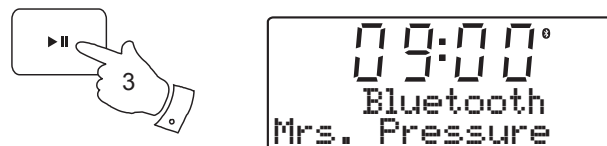
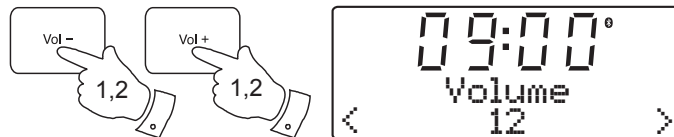

Connecting and reconnecting a Bluetooth device

You can only have one Bluetooth device connected to the sound system at any one time although it may be paired with several devices. Once you have a Bluetooth enabled device connected to your sound system it cannot be interrupted by another Bluetooth device unless you choose to break the connection.

- To connect to a different device, press and hold the **Menu** button on the sound system to access the menu options.
Press and release the **Tuning up** or **Down** button to display the 'Bluetooth Menu' option. Press and release the **Select** button.
- The radio will then display a list of previously connected devices. Press and release the **Tuning up** or **Down** button to step through the list.
To connect to a previously connected device, press and release the **Select** button when the device's name is displayed. In some cases you may also need to re-enable the connection from your device's Bluetooth settings. The sound system will then connect to the device.
- To connect to a new device, press and release the **Tuning up** or **Down** button until 'PAIRING' is displayed then press the **Select** button. The sound system will become 'discoverable' by other devices. The **Bluetooth indicator** on the front panel will flash and 'Bluetooth Pairing...' will be shown. The sound system will then be discoverable by other devices.
- Then pair the sound system with the new device using its Bluetooth settings (the sound system will be listed as 'Blutune 200'). The name of the newly connected device will be briefly shown on the sound system's display. You may then play music from the new device through the sound system.
- If you no longer want your Bluetooth device to be paired with your sound system you will need to delete the 'Blutune 200' pairing on the device. Please refer to the device's Bluetooth documentation.

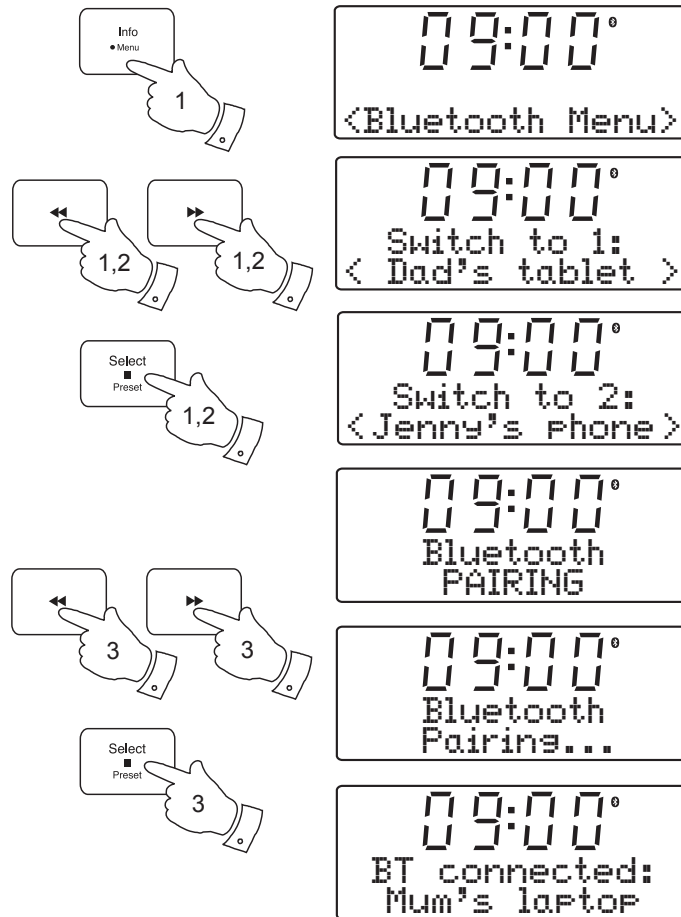

Compact discs

Use only Digital Audio CDs which have the  symbol.

Use only full size CDs (12cm diameter) with the sound system. Mini CDs (8cm diameter) are not compatible with the player and may jam the CD mechanism.

Transparent or partly transparent CDs cannot be played since they may not be detected when inserted. Unusually thin (Eco) CDs cannot be played. Some copy-protected CDs may not be playable.

Never write on a CD or attach any sticker to the CD. Always hold the CD at the edge and store it in its box after use with the label facing up.

To remove dust and dirt, breathe on the CD and wipe it with a soft, lint free cloth in a straight line from the centre towards the edge.

Cleaning agents may damage the CD.

Do not expose the CD to rain, moisture, sand or to excessive heat. (e.g. from heating equipment or in motor cars parked in the sun).

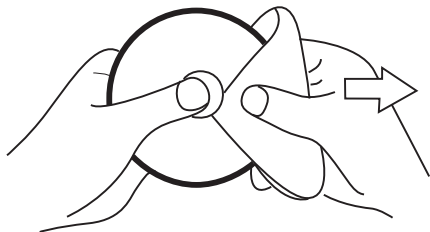

CD-R/CD-RW discs

Your Blutune 200 sound system can playback CD-DA format audio CD-R/CD-RW discs that have been finalised* upon completion of recording.

*Finalising enables a CD-R/CD-RW disc to playback on audio players such as your sound system. A disc which has not been finalised may have information added to it using a computer but may not always be playable. You may have to specifically enable the finalising step with some CD writing software.

Your sound system may fail to play some CD-R/CD-RW discs due to poor recording and wide variation in quality of the CD-R/CD-RW disc.

Inserting a CD

Ensure the CD player is empty before inserting a disc. If there is a disc in the player then the CD loaded indicator will be lit. If you cannot insert a disc, press the **CD Eject** button to remove the CD currently in the player.

1. Press and release the **On / Standby** button to switch on your sound system.
2. To select the CD mode press the **Mode** button until 'CD' shows on the upper line of the display.
3. To eject a CD press and release the **CD Eject** button. To reload a CD that has just been ejected, press the **Eject** button a second time.
4. Insert a disc with printed side facing up into the CD slot. The disc will be loaded automatically. The unit will check the CD type and load its track list. The display will show 'LOADING' and then 'READING' as the information is read.
5. If you load a disc containing MP3 or WMA files your sound system will enter the MP3 / WMA mode (see page 34).

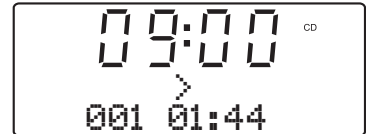
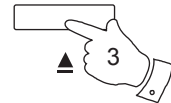
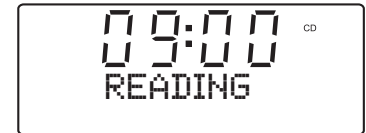
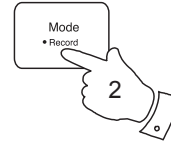
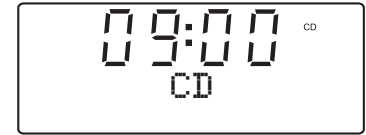
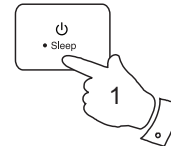

Playing a CD

1. Press the **Play / Pause** button to start playing the disc. The display will show the first track number.
2. Adjust the **Volume** to the required setting.
3. To pause playing press the **Play / Pause** button. To resume press the **Play / Pause** button again.
4. To stop playback, press the **Stop** button.

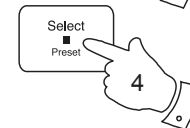
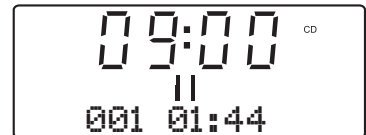
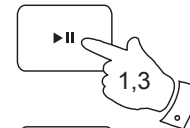

5. If you put the unit into standby mode then the next time the unit is switched on it will return to the previously played track.

Ejecting a CD

1. To take out the CD, press and release the **CD Eject** button. The display will show 'EJECT'. In order to protect the disc if it is not removed, the unit will reload the CD after 10 seconds and then enter standby mode.
2. In the event that the CD fails to eject, *press and hold* the **CD Eject button**. This will cause the CD player to eject the disc even if it is unable to detect the presence of an inserted CD (as may happen if the CD has a large area of transparency).

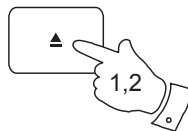

Selecting a track

1. While the CD is playing, press either the **Fast-forward** or **Rewind** buttons to change to the desired track. The updated track number is shown in the display.
2. You can also skip tracks when the player is paused or stopped. Skip to the desired track using the **Fast-forward** or **Rewind** buttons, release the button when the desired track is displayed.
3. Press the **Play / Pause** button to play the selected track.

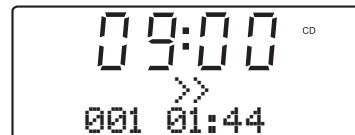
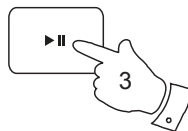
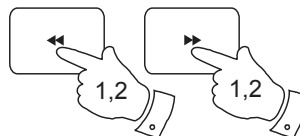

Search function

1. While the CD is playing, press and hold the **Fast-forward** or **Rewind** buttons. Release the button when the desired part of the track is reached.

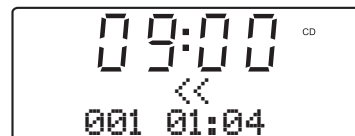
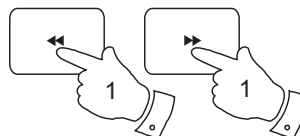

Repeat tracks

1. While the CD is playing, press and hold the **Menu** button.
2. Press the **Tuning Up** or **Down** buttons until 'Repeat' shows on the display. Press the **Select** button to enter the repeat options menu.
3. Press the **Tuning Up** or **Down** buttons until the required repeat option shows on the display and then press the **Select** button to confirm the setting.

- Off - The repeat function will be disabled.
 One (1) - The current track (a single track) will be repeated.
 All (ALL) - All tracks on the CD will be played repeatedly.
 Dir (FOLDER) - All tracks in the current folder will be played repeatedly.

Selecting a repeat option will cancel the shuffle setting if previously applied.

When the repeat function is On, the repeat symbol  is shown along with one of the repeat option symbols above.

Note: The folder repeat option (Dir) is only applicable when using a CD containing MP3 or WMA files (see page 34).

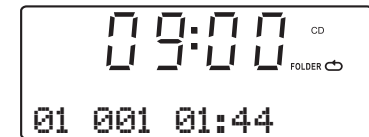
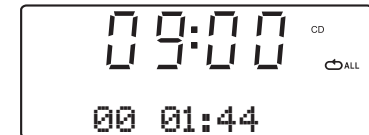
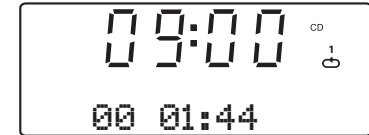
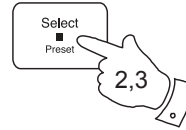
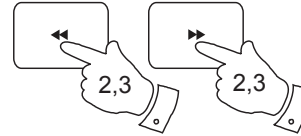
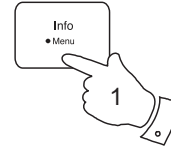

Shuffle tracks

1. While the CD is playing, press and hold the **Menu** button.
2. Press the **Tuning Up** or **Down** buttons until 'Shuffle' shows on the display. Press the **Select** button to enter the shuffle options menu.
3. Press the **Tuning Up** or **Down** buttons until the required shuffle option shows on the display and then press the **Select** button to confirm the setting.

Off - The shuffle function will be disabled.

On - All tracks will be played in random order.

Selecting the shuffle option will cancel any repeat setting if previously applied.

Pressing Stop or ejecting the CD will cancel any repeat or shuffle setting.

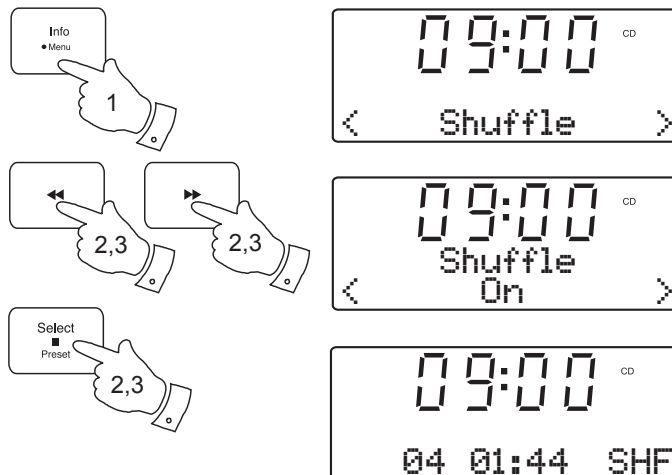

MP3/WMA CD Mode

The Blutune 200 sound system is able to play CD-R and CD-RW discs containing MP3 and WMA files. It is assumed in this section that a file is equivalent to a CD track.

An MP3 / WMA CD may not contain more than 511 files and not more than 99 folders. MP3 and WMA files should be created with an audio sample rate of 44.1kHz (this is normal for files created from CD audio content). MP3 and WMA data rates up to 320 kilobits per second are supported. WMA Lossless, WMA Voice, WMA 10 Professional and files which have DRM protection are not supported.

When burning CD-R and CD-RW discs with audio files, various problems may arise which could lead to problems with playback. Typically such problems are caused by poor CD writing or audio encoding software, or by the hardware settings of the PC's CD writer, or by the CD being used. Should such problems arise, contact the customer services of your CD writer or software manufacturer or look in their product documentation for relevant information. When you are making audio CDs, take care to observe all legal requirements and ensure that the copyright of third parties is not infringed.

1. To select the CD mode press and release the **Mode** button until 'CD' shows on the display, or insert a suitably prepared CD-R or CD-RW disc.
2. Insert a CD with printed side facing up into the CD slot. The disc will be loaded automatically. The unit will check the CD type and load its track list. The display will show 'loading' and then 'reading' as the information is read.
If there are many files or folders on the CD then it may take some tens of seconds to read all of the file and folder names and to identify those which are playable (with .mp3 or .wma filename extension).

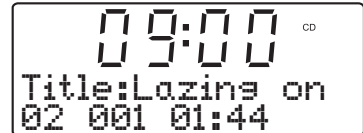
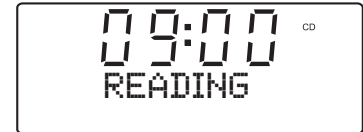
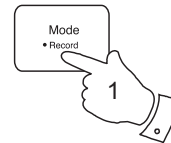

Playing an MP3/WMA CD

1. Press the **Play/Pause** button to start playing from the CD. The display will show the first folder and file numbers - '01' and '001'.
2. To pause playing press the **Play / Pause** button. To resume playing press the **Play / Pause** button again.

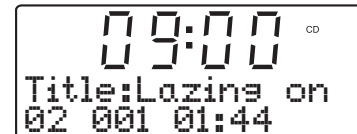
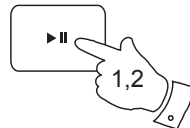

If you put the unit into standby mode then the next time the unit is switched on it will return to the previously played file.

3. To Stop playback, press the **Stop** button.

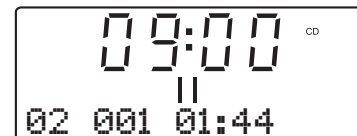
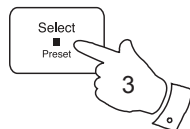

4. To take out the CD, press the **CD Eject** button. The display will show 'EJECT'. In order to protect the disc if it is not removed, the unit will reload the disc after 10 seconds and then enter standby mode. To reload a CD that has just been ejected, press the **Eject** button a second time.

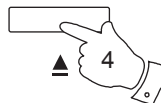

Selecting a file

1. While the CD is playing, press either the **Fast-forward** or **Rewind** buttons to change to the desired file, the file number is updated in the display. If there is more than one folder, when all files in the current folder have been played the next folder will be played.
2. You can also skip files when the player is in stop mode. Skip to the desired file using the **Fast-forward** or **Rewind** buttons and release the button when the desired file number is displayed.
3. Press the **Play / Pause** button to play the selected file.

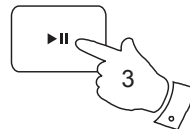
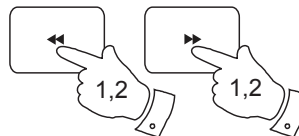

Search function

1. While the MP3 / WMA CD is playing, press and hold the **Fast-forward** or **Rewind buttons**. Release the button when the desired part of the current file is reached.

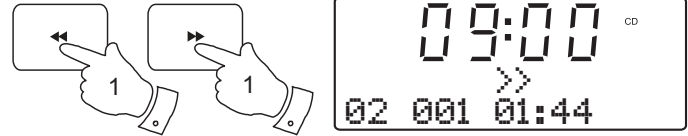

To skip to another folder

1. With the MP3 / WMA CD in stop or play mode, press and release either the **Up** or **Down Folder** buttons. The first file of the next or previous folder will be played.

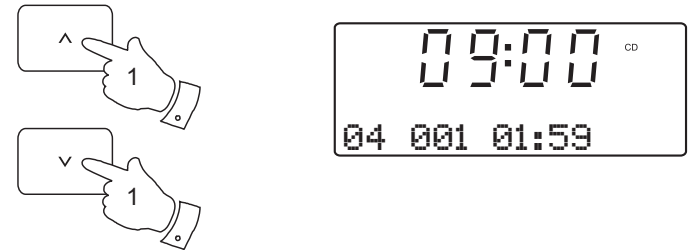

Repeat and shuffle options

The Blutune 200 allows you to use the same playback options for files as can be used for conventional CDs (see pages 30-33). In addition to repeat a single file and repeat all options, there is also a repeat folder facility.

Using SD cards and USB memory devices

This section describes how to use your sound system to access and playback your audio files via USB memory devices and Secure Digital (SD, SDHC) cards. The Blutune 200 can also record to SD, SDHC or USB media in MP3 format.

Important: Your sound system is only designed to work with USB memory flash memory devices. It is not intended to be connected to computers, hard disk drives or any other type of USB device.

The Blutune 200 has been tested with a range of USB memory devices of up to 32GB capacity, SD cards up to 2GB, and SDHC cards up to 32GB. However, there are many different card variants available and not all cards can be guaranteed to work in the Blutune 200. Higher capacity SDXC cards are not supported. Memory must be formatted using the FAT or FAT 32 filing system in order to operate in the Blutune 200.

Audio formats supported for playback are MP3 and WMA. Playback does not support files encoded using WMA Lossless, WMA Voice, WMA 10 Professional, nor files of any format which have DRM protection.

The SD card and USB slots are located on the rear panel of your sound system.

Inserting and removing memory devices

1. To insert an SD card into your sound system push the card label side upward and gold contacts first into the card slot on the rear of your sound system until it clicks. To remove the card push the card in so that it clicks once more. It will then be pushed out slightly allowing removal.

USB memory devices plug into the rectangular slot on the rear of your sound system.

2. To select either SD card or USB mode press the **Mode** button until the desired mode is shown on the display.

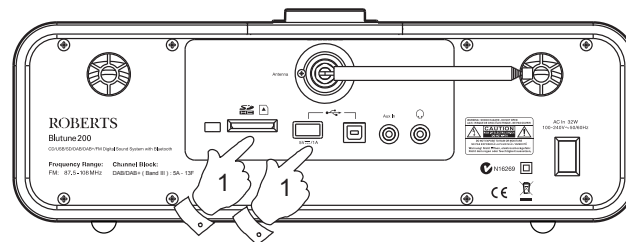

Cautions:

In order to minimise the risk of damage to your sound system, your SD card or your USB memory, please place the unit such that the device cannot easily be knocked while it is inserted in the socket.

Remove the USB memory or SD card before carrying the unit or if not using the USB or SD feature for a prolonged period.

Place the unit in Standby mode before removing your SD card or USB memory device.

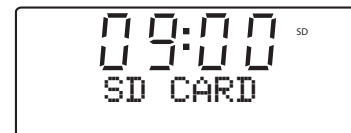
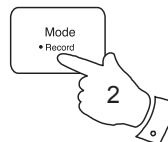

Playing MP3/WMA files - SD/USB

1. Press the **Play / Pause** button to start playing from the SD card / USB memory device. The display will show the first folder and file numbers - "01" and "001".
2. To pause playing press the **Play / Pause** button. To resume playing press the **Play / Pause** button again.
3. To stop play, press the **Stop** button. The total number of files and folders on the media and the stop symbol (■) will be displayed.

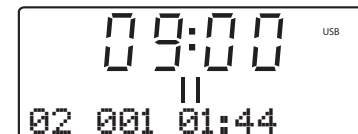
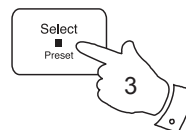
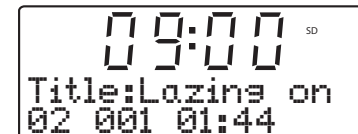
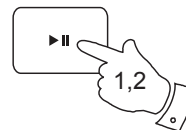

Selecting a file

1. While the SD card / USB memory device is playing, press either the **Fast-forward** or **Rewind** buttons to change to the desired file. The file number is updated in the display. If there is more than one folder, when all files in the current folder have been played the next folder will be played.
2. You can also skip files when the player is in stop mode. Skip to the desired file using the **Fast-forward** or **Rewind** buttons and release the button when the desired file number is displayed.
3. Press the **Play / Pause** button to play the selected file.

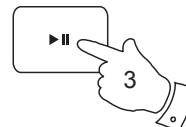
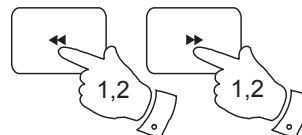

Search function

1. While the SD card / USB memory device is playing, press and hold the **Fast-forward** or **Rewind** buttons. Release the button when the desired part of the current file is reached.

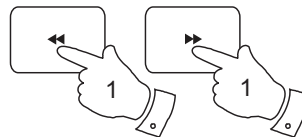

To skip to another folder

1. Whether the SD card / USB memory device is playing or stopped, press and release either the **Up** or **Down Folder** buttons. The first file of the next or previous folder on the memory will be played.

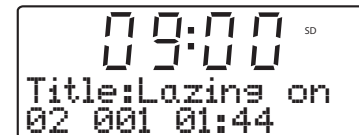
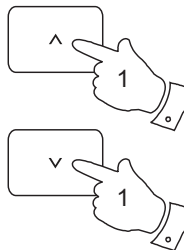

Repeat and shuffle options

The Bluetooth 200 allows you to use the same playback options for files as can be used for conventional audio CDs (see pages 30-33). In addition to Repeat Once and Repeat All options, there is also a Repeat Folder facility.

Recording to SD/USB

Your Blutune 200 sound system has been designed to allow you to make recordings to SD / SDHC cards or to USB connected memory devices. Recordings are made in MP3 format at 128k bits per second.

SD / SDHC or USB memory media must use the FAT or FAT32 file system in order to operate with the Blutune 200. Such media is usually supplied already formatted or can be formatted using a PC with a suitable card reader (for SD / SDHC cards) or USB connection (for USB memory).

It is possible to record onto media which already contains files written by the radio or your computer. The recorded files will be added to those already present on the media.

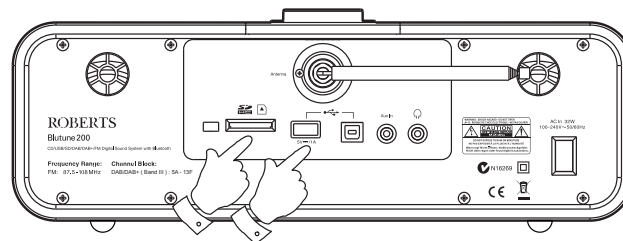

Making a recording

1. Select the desired source for the recording (DAB, FM, CD, etc.). AUX-IN is shown in the illustration. Set the volume to the required listening level (the volume of the recording will not be affected by this).
2. Insert the media on to which the recording is to be made.
3. **Press and hold** the **Record** button. The display will show "Record init...".

If only one media type is present, then after a short while recording will start.

If both SD and USB media are detected, then a menu is offered to allow you to choose between Card and USB recording. Select one or the other as needed using the **Tuning Up** or **Down** buttons and then press the **Select** button. Recording will then start with the recording duration being shown on the display.

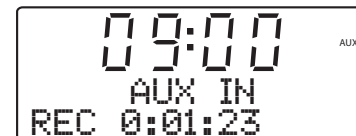
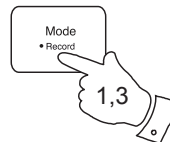

Making a recording cont.

If recording from a CD, recording will be started from the beginning of the currently playing track. Each track on the CD will be recorded as a separate file on the media.

4. In order to stop the recording **press and hold** the **Record** button once more. Recording will stop and a file will have been written to the storage media.

Files that have been written to the media are held in a folder called "RECORD". Recordings are held in sub-folders according to the source used for the recording.

The illustration shows the folders as they may appear on a PC running Windows with files in the CD folder being shown to the right. Other folders on the memory device were copied there from the PC.

AUXIN - for recordings from the Auxiliary input
BT - for recordings from Bluetooth devices
CD - for recordings from CD audio discs
COPY - for recordings from SD / USB / CD (MP3/WMA)
DAB, FM - for recordings from DAB and FM radio

Note: The SD card / USB memory device should only be removed when recording is stopped. Removing media while recording is in progress may corrupt data on the card leading to the loss of files previously written.

The USB connection is intended to be used to allow the Blutune 200 to play MP3 and WMA files from solid-state flash memory devices. The USB connection is not intended to be connected to other USB devices such as computers or hard disk drives. If you wish to play files from another music player, then we recommend that this is connected to the Auxiliary input socket - see page 55.

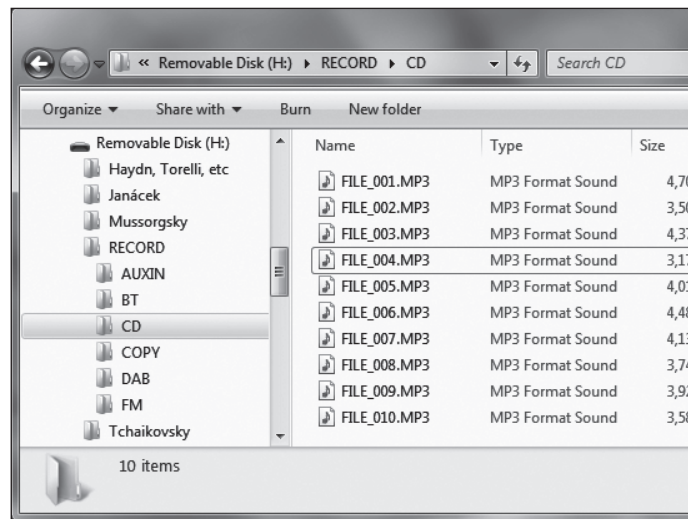
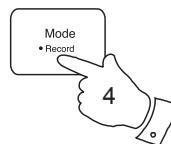

If you wish to make recordings from radio, we recommend recording from DAB radio if possible since it is generally less susceptible to interference than FM radio. If you need to record from FM radio, some interference may be picked up from the memory device unless you have a strong signal. The use of an external aerial for FM listening and recording can significantly improve the FM signal under these conditions. The section "Aerial removal" on page 59 of this booklet explains how to remove the telescopic aerial so that an external aerial can be connected via coaxial cable to the antenna connector.

Recording MP3/WMA files from CD/SD/USB

In addition to recording from conventional sources, the Blutune 200 sound system can also record from MP3 or WMA files that have previously been written to CD, SD or USB media. In this case the files are copied rather than re-encoded to MP3 in order to avoid a reduction in quality. You may copy files from CD or SD to USB and from CD or USB to SD.

1. Select the desired source for the recording (SD, USB or CD).
2. Press the **Play / Pause** button to start playing the source media (if it does not automatically start). Set the volume to the required listening level (the volume of the recording will not be affected by this).
3. Insert the media that the files will be recorded on to (SD or USB).
4. **Press and hold** the **Record** button. The display will show "Record init...".
5. If only one media type is present, the audio will stop while the source media is taken back to the beginning of the current file. Recording will then start.
6. If both SD and USB media are detected, then a menu is offered to allow you to choose between Card and USB recording. Select one or the other as needed using the **Tuning Up** or **Down** buttons and then press the **Select** button. The source media will be taken back to the beginning of the current file and recording will then start.
7. In order to stop the recording press and hold the **Record** button once more. Recording and playback will stop and all files that have been played will have been copied to the storage media.

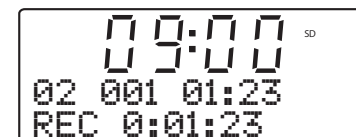
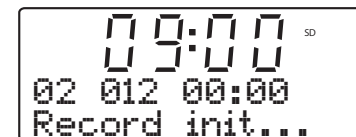
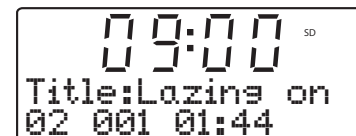
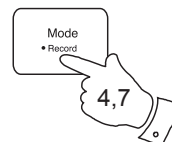
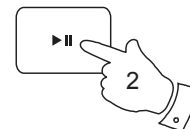
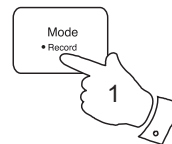

Deleting and formatting

After having recorded files to SD or USB media, you may later wish to delete them in order to reclaim the space used. The Blutune 200 can be used to delete individual files, or to delete all of the media files on the card.

Deleting a single file

The single file delete function is able to delete the file currently playing (or playing but paused).

1. With the sound system in USB or SD mode, with the media inserted and with the file to be deleted playing or paused, press and hold the **Menu** button.
2. Press the **Tuning Up** or **Down** buttons until the display shows "Delete / Format".
3. Press the **Select** button to enter the Delete / Format menu. The display will show "Delete" as the default option.
4. In order to delete a single file (the file which is currently displayed), press the **Select** button once more. The display will show "Cancel" as the default option.
5. If you do not wish to delete the file, press the **Select** button with "Cancel" displayed.

Alternatively, to delete the file press one of the **Tuning Up** or **Down** buttons to display "OK" and then press the **Select** button.

The file will be deleted and the details of the next file will be displayed. If there are no more files left on the media, then the display will show "No file".

Note: Once a file has been deleted, it is not possible to recover the file.

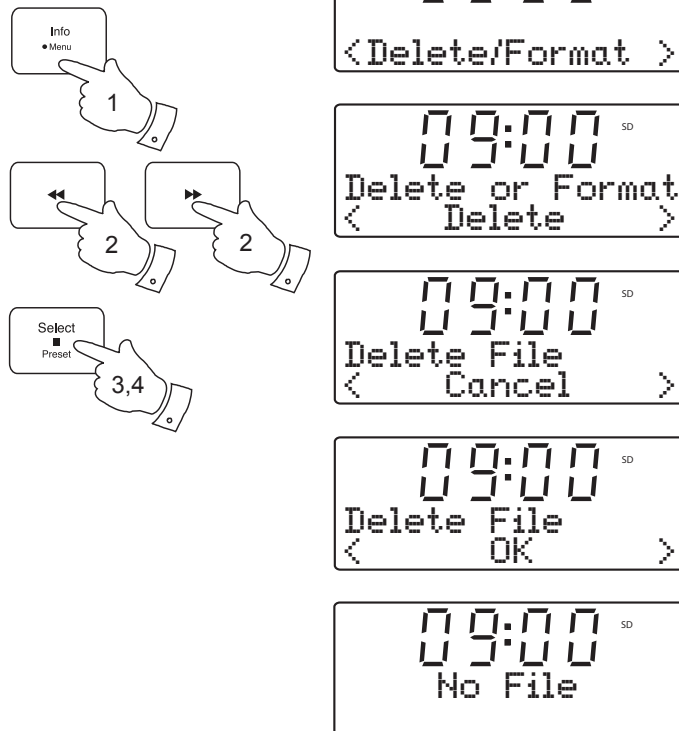

Deleting all files

1. With the sound system in USB or SD mode, and with the media inserted, press and hold the **Menu** button.
2. Press the **Tuning Up** or **Down** buttons until the display shows "Delete / Format".
3. Press the **Select** button to enter the Delete / Format menu. The display will show "Delete" as the default option.
4. Press one of the **Tuning Up** or **Down** buttons so that "Format" is displayed.
5. In order to delete all of the files and folders on the media, press the **Select** button once more. The display will show "Cancel" as the default option.
6. If you do not wish to delete all of the files on the media, press the **Select** button with "Cancel" displayed.

Alternatively, to delete all of the files press one of the **Tuning Up** or **Down** buttons to display "OK" and then press the **Select** button.

The display will show "Formatting..." while all of the files and folders on the card are deleted. The operation will generally only take a few seconds. When completed, the display will show "No file".

Note: Although the process of deleting all of the files is described here as formatting, it is not formatting in the strict sense. Rather it is a "Delete All Media Files" option.

Once a device has been formatted, it is not possible to recover the previous contents.

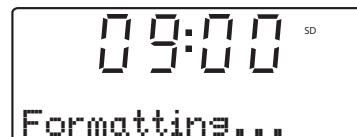
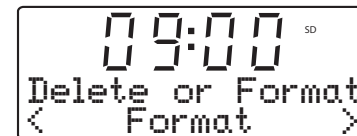
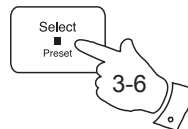
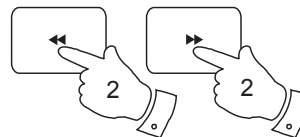
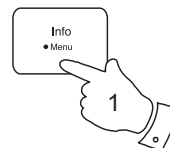

Alarms

Your sound system has two alarms which can each be set to wake you to DAB, FM radio, CD, USB, SD card or buzzer alarm. The alarms may be set while the unit is in standby mode or while playing.

Note: If no buttons are pressed for several seconds, your sound system will exit the alarm setup. To exit the alarm setup at any time press and release the **Menu** button as needed.

1. Before setting an alarm ensure that the clock time is set (see page 50). Press and hold the **Menu** button.
2. Press the **Tuning Up** or **Down** buttons until 'Set alarm' shows on the display. Press and release the **Select** button to enter the alarm setup menu.
3. Press the **Tuning Up** or **Down** buttons to display the required alarm, 1 or 2. Press and release the **Select** button 'Alarm Setting' will show on the display.
4. Press and release the **Select** button to choose alarm setting. 'Alarm: On/Off' will show on the upper line of the text display.
5. Press the **Tuning Up** or **Down** buttons to choose whether to set the alarm to On or Off. If Off is selected, the unit will exit the alarm menu.
6. With 'On' selected on the display, press and release the **Select** button. 'Alarm: Time' will show on the upper line of the text display and the Alarm hour digits will flash.

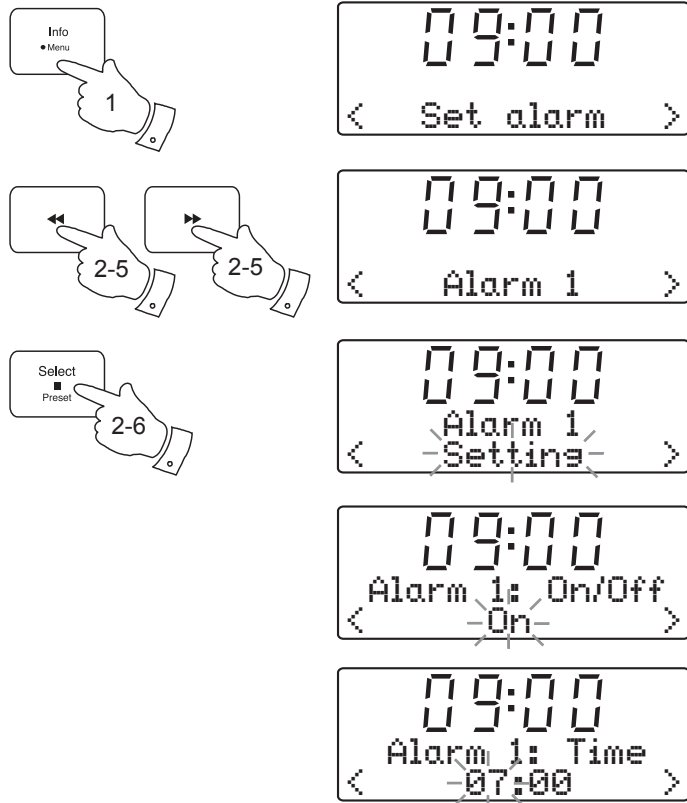

7. Press the **Tuning Up** or **Down** buttons to choose the alarm hour and then press and release the **Select** button to enter the hour setting. The Alarm minute digits will then flash on the display.

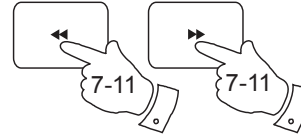

8. Press the **Tuning Up** or **Down** buttons to choose the alarm minute and then press and release the **Select** button to enter the minute setting. 'Alarm: Mode' will show on the upper line of the text display.

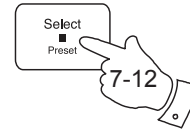

9. Press the **Tuning Up** or **Down** buttons to choose the required alarm mode and then press the **Select** button to confirm the setting.



Each alarm can be set to any of the following modes:

- BUZZER - will wake you with a buzzer alarm
- DAB - will wake you with DAB radio
- FM - will wake you with FM radio
- CD - will wake you playing a CD
- USB - will wake you playing from a USB memory device
- SD card - will wake you playing from an SD card

10. Press and release the **Select** button to select the alarm mode. 'Alarm: Day' will show on the upper line of the text display.



11. Press the **Tuning Up** or **Down** buttons to select the required day option for the alarm. Your alarm can be set to the following options:

- Once - will sound at one time only
- Daily - will sound everyday
- Weekdays - will sound only on weekdays
- Weekends - will sound only at weekends

12. Press and release the **Select** button. The alarm volume will flash on the display. The sound system uses the saved volume setting for each alarm when it sounds.

13. Press the **Tuning Up** or **Down** buttons to select the desired alarm volume.

14. Press and release the **Select** button to confirm the alarm settings.
The sound system will exit the alarm menu.

Active alarms are indicated in the display by the  symbol and the corresponding alarm number.

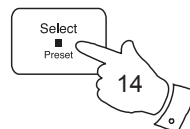
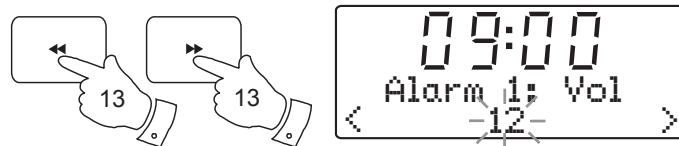

When the alarm sounds

The alarm will sound at the selected times for up to 60 minutes unless cancelled. The volume used for the alarm will be specified during the alarm setting procedure. If the radio cannot connect to the specified radio station, the buzzer will be used instead.

Note: If the radio is switched on because of a radio alarm you can only use the volume and on/off controls. See Snooze function on the next page.

When the buzzer alarm activates it will start softly and gradually increase in level.

The alarm icon will flash on the screen and the radio will automatically switch back to standby mode when the 60 minutes have elapsed.

Cancelling an alarm

To cancel the alarm press while it is sounding and release the **On / Standby** button.

To cancel an alarm at any other time, enter the alarm setup menu and set the alarm On/Off option to 'Off'. See steps 1-5 page 45.

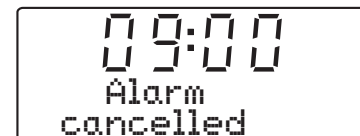

Snooze function

1. When the alarm sounds, pressing **any button** other than the On / Standby or Volume buttons will silence the alarm for 5 minutes. The Snooze symbol (zzZ) will flash. This sequence can be repeated during the 60 minute alarm period.
2. To cancel the Snooze function, press the **On / Standby** button.

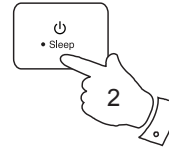

Viewing the alarm settings

1. To view the alarm settings press and hold the **Menu** button.
2. Press the **Tuning Up** or **Down** buttons until 'Set alarm' shows on the display. Press and release the **Select** button to enter alarm setup menu.
3. Press the **Tuning Up** or **Down** buttons to display the required alarm, 1 or 2. Press and release the **Select** button.
4. Press the **Tuning Up** or **Down** buttons until 'View' shows on the display.
5. Press and release the **Select** button to cycle through each of the settings for the chosen alarm.

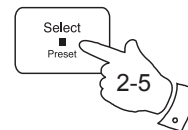
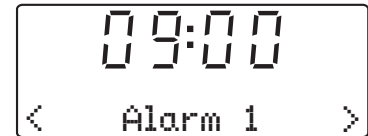
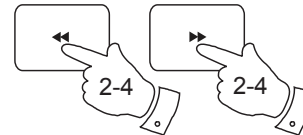
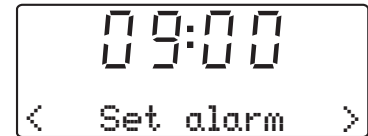
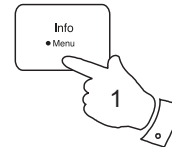

Sleep function

Your sound system can be set to turn off after a preset time has elapsed. The sleep setting can be adjusted between 15 and 120 minutes. Ensure your sound system is switched On.

1. When using your sound system, press and hold the **Sleep** button. 'Sleep time' appears on the display.
2. Press the **Tuning Up** or **Down** buttons to select the desired sleep time. The options are 15, 30, 60, 90 or 120 minutes. A further press will cause the sleep timer to be set to Off which will cancel the sleep function.
3. Press and release the **Select** button. The display will exit the sleep options. The sleep symbol  will show on the display.
4. Your sound system will switch off after the preset sleep time has elapsed.
5. To cancel the sleep timer and switch off your sound system before the chosen sleep time has elapsed, press and release the **On / Standby** button.
To cancel the sleep timer without switching off your sound system, set the sleep timer to 'Off' in step 2 above.

6. When the sleep time has been set you may view the remaining sleep time. Press and hold the **Sleep** button. The remaining sleep time will show on the display.

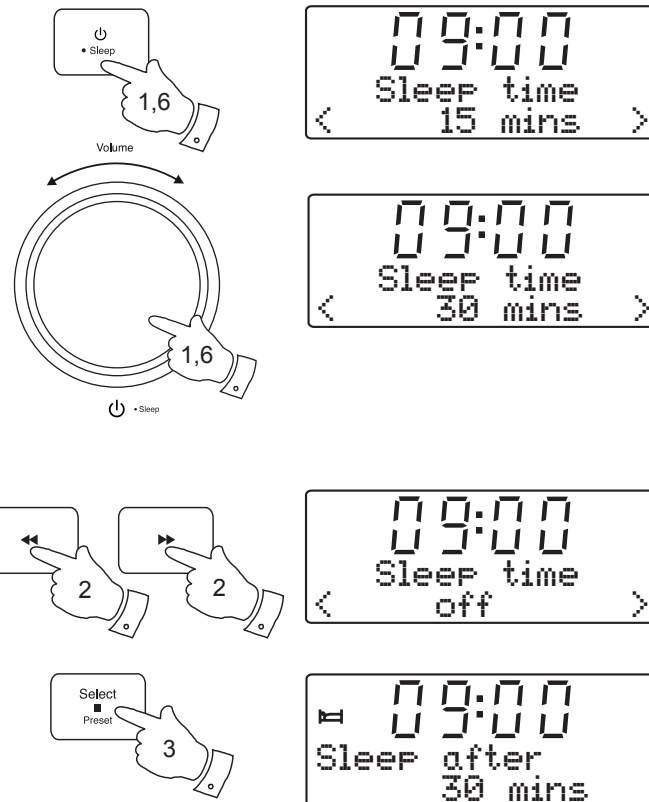

Setting the clock manually

Normally your sound system will set its clock automatically using the DAB radio signal. If no DAB signal is available and you need to set the time manually, please follow the procedure shown below. The clock may be set while the unit is in standby mode or while playing.

1. To set the clock time, press and hold the **Menu** button.
2. Press the **Tuning Up** or **Down** buttons until 'Set clock' appears on the display. Press and release the **Select** button.
3. Press the **Tuning Up** or **Down** buttons until 'Manual' appears on the display.
4. Press and release the **Select** button. The hour digits will then flash on the display.
5. Press the **Tuning Up** or **Down** buttons to set the desired hour.
6. Press and release the **Select** button to enter the hour setting. The minute digits will then flash on the display.
7. Press the **Tuning Up** or **Down** buttons to set the desired minute.
8. Press and release the **Select** button. The year will then flash on the display.

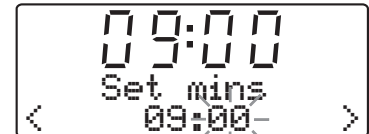
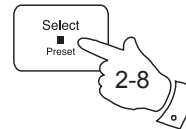
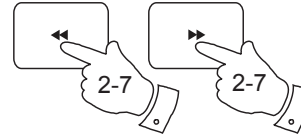
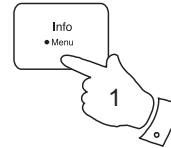

9. Press the **Tuning Up** or **Down** buttons to select the current year.
10. Press and release the **Select** button to enter the year setting. The month will then flash on the display.
11. Press the **Tuning Up** or **Down** buttons to set the current month.
12. Press and release the **Select** button to enter the month setting. The day will then flash on the display.
13. Press the **Tuning Up** or **Down** buttons to change the day as needed.
14. Press and release the **Select** button to confirm the clock setting. The sound system will exit the menu.

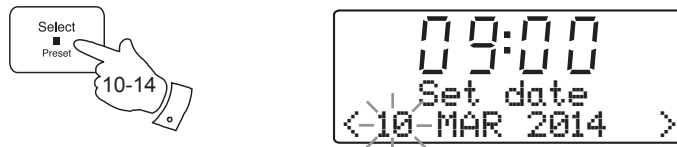
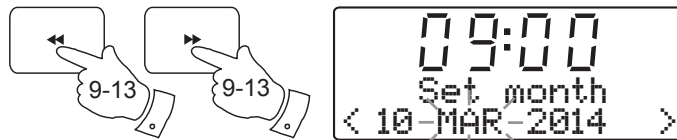

To return to auto clock set mode

The auto clock set mode may be set while the unit is in standby or while playing.

1. Press and hold the **Menu** button.
2. Press the **Tuning Up** or **Down** buttons until 'Set clock' appears on the display. Press and release the **Select** button.
3. Press the **Tuning Up** or **Down** buttons until 'Auto' appears on the display. Press and release the **Select** button.
4. The sound system will set its time according to the information received with the DAB broadcast when the radio is tuned to a DAB station.

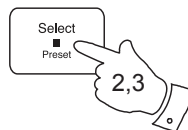
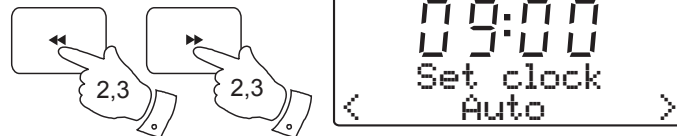
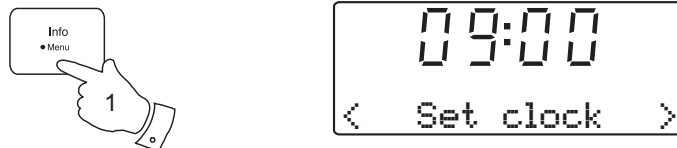

Equalizer function

The sound on your Blutune 200 can be adjusted to suit your personal taste for the material that you are listening to. The sound system has six preset equalizer options. Alternatively, you may set the treble and bass levels to your own preferences.

1. Press and release the **On / Standby** button to switch on the sound system.
 2. Press and hold the **Menu** button.
 3. Press the **Tuning Up** or **Down** buttons until 'Set Equalizer' appears on the display.
 4. Press and release the **Select** button to enter the equalizer menu.
 5. Press the **Tuning Up** or **Down** buttons to cycle through the various options until the desired option is displayed. Press and release the **Select** button to confirm your choice.
 - a. Flat - no tone modification is applied
 - b. Jazz
 - c. Rock
 - d. Classic
 - e. Pop
 - f. News
- For details on setting the treble and bass settings, please see overleaf.

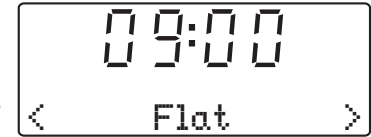
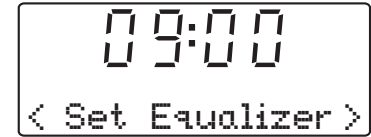
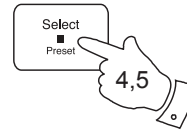
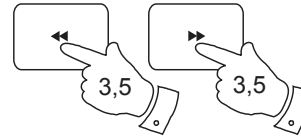
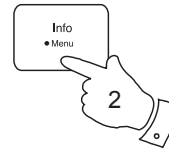

Treble control

1. Follow steps 1-4 on the preceding page to enter the Equalizer setup menu.
2. Press the **Tuning Up** or **Down** buttons to cycle through the options until 'Treble' appears on the display.
3. Press and release the **Select** button. The current treble setting will be displayed.
4. To adjust the treble setting press the **Tuning Up** or **Down** buttons until the desired level is displayed.
5. Press and release the **Select** button to confirm the setting.

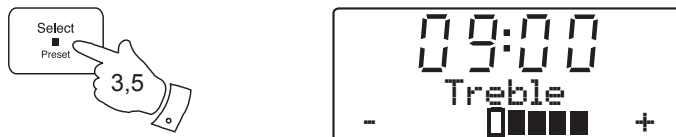
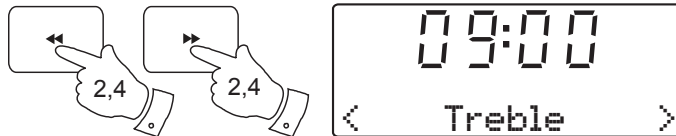

Bass control

1. Follow steps 1-4 on the preceding page to enter the Equalizer setup menu.
2. Press the **Tuning Up** or **Down** buttons to cycle through the options until 'Bass' appears on the display.
3. Press and release the **Select** button. The current Bass setting will be displayed.
4. To adjust the Bass setting press the **Tuning Up** or **Down** buttons until the desired level is displayed.
5. Press and release the **Select** button to confirm the setting.

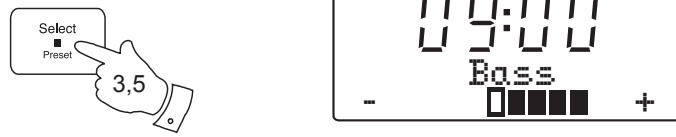

Mute function

When playing in DAB, FM radio or Auxiliary input mode, the Play / Pause button has a mute function. Pressing the Play / Pause button will mute the output from the loudspeakers.

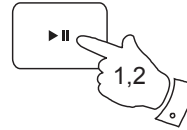

1. Press and release the **Play / Pause** button to mute the sound output. The speaker volume symbol on the display will disappear.
2. Press and release the **Play / Pause** button again or one of the **Volume** buttons to un-mute the sound output.

Auxiliary input socket

A 3.5mm stereo **Auxiliary Input socket** is provided on the rear of your sound system to permit an audio signal to be fed into the unit from an external audio device such as iPod, MP3 or CD player.

1. Press and release the **Mode** button until "AUX IN" is displayed.
2. Connect an external audio source (for example, iPod, MP3 or CD player) to the **Auxiliary input socket**.
3. Adjust the volume setting on your iPod, MP3 or CD player if necessary to ensure an adequate signal level, and then use the **Volume Up** or **Down buttons** or the rotary control on the sound system as needed for comfortable listening.

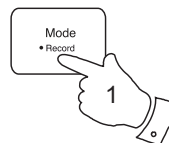
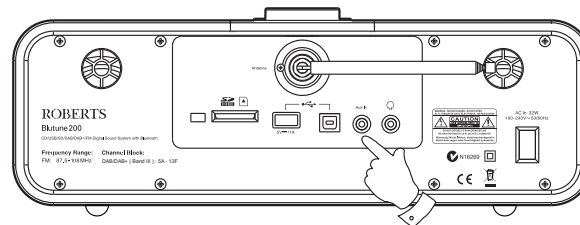

Headphone socket

A 3.5mm stereo **Headphone Socket** is provided on the rear of your sound system for use with headphones. Inserting a plug automatically mutes the internal loudspeakers.

Please be aware that the sensitivity of headphones can vary widely. We therefore recommend setting the volume to a low level before connecting headphones to the sound system.

IMPORTANT: Excessive sound pressure from earphones and headphones can cause hearing loss.

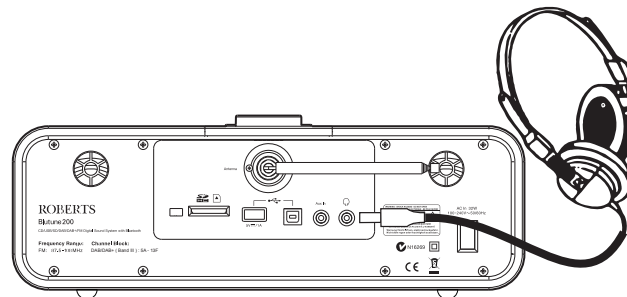

To prevent possible hearing damage, do not listen at high volume levels for long periods.

Standby brightness control

The brightness of the display when the unit is in standby mode may be adjusted. If you use the unit in the bedroom, you may prefer a lower standby brightness level than the standard setting.

The standby brightness level may be set while the unit is in standby or while it is playing.

1. Press and hold the **Menu** button.
2. Press the **Tuning Up** or **Down** buttons until the display shows 'Set Brightness' on the lower line of the text display.
3. Press and release the **Select** button to show the current setting.
4. Press the **Tuning Up** or **Down** buttons to change the standby brightness level. The backlight level will change at the same time so that you can see the effect of the change when the unit is in standby mode.
5. Press and release the **Select** button to save the new setting.

The default setting after a system reset is 5. Possible brightness values range from 1 - 7.

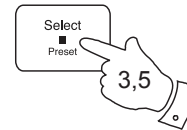
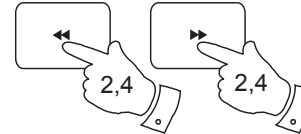
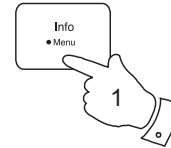

System reset

If your sound system fails to operate correctly, or some digits on the display are missing or incomplete carry out the following procedure.

1. Press and hold the **Menu** button.
2. Press the **Tuning Up** or **Down** buttons until the display shows 'System reset'.
3. Press and release the **Select** button. The display will show 'Press SELECT to reset'.
4. Press and release the **Select** button again to confirm the reset operation.
5. A full reset will be performed. The station list and presets will be erased. Alarms will be cancelled, audio equalizer and display brightness settings will have been set to their default values. The clock will be reset and the unit will behave as when first switched on (see page 9).

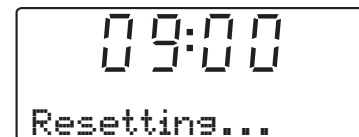
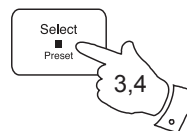
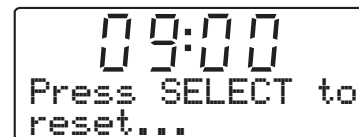
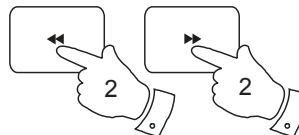
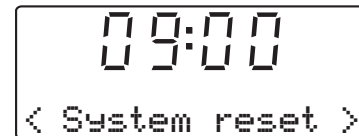
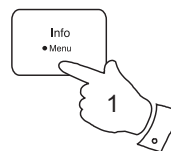

In case of malfunction due to electrostatic discharge, reset the product using the above procedure. In some circumstances it may be necessary to disconnect and then reconnect the mains power in order to resume normal operation.

If a problem persists please refer to the guarantee section at the back of this instruction book which explains how to obtain support for your sound system.

Software version displays

The sound system has the means to display the version numbers of the different software components that allow it to function. These displays are provided for reference in case they are needed for service or customer support.

To display the system software version...

1. Press and hold the **Menu** button.
2. Press the **Tuning Up** or **Down** button until the display shows the software version information for a few seconds.



To display the DAB/FM radio software version...

1. In DAB mode press and hold the **Menu** button. 'DAB Menu' will appear on the display. Press and release the **Select** button to enter the DAB menu.
2. Press the **Tuning Up** or **Down** button until the 'SW Version' option is displayed. Press and release the **Select** button to display the software version information for a few seconds.
3. Press and release the Menu button to cancel the display.

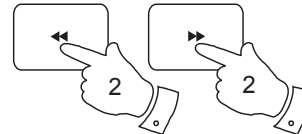
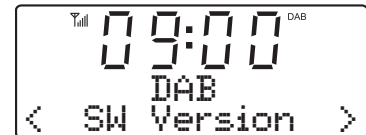
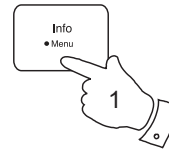

To display the CD/MP3/WMA software version...

1. In CD mode with no CD inserted press and hold the **Menu** button.
2. Press the **Tuning Up** or **Down** button until the display shows the CD software version information for a few seconds.

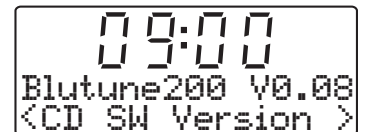

Aerial removal

The fitted telescopic aerial is suitable for most applications. A wire aerial is provided as an alternative, and the telescopic aerial may be removed to allow this to be fitted, or to allow connection to an external aerial using a coaxial cable.

First remove the two small screws holding the antenna connector cover in place using a small cross-head screw driver. Then using the supplied spanner, remove the telescopic aerial by rotating in an anti-clockwise direction when viewed from the rear of the product.

The wire aerial simply pushes on to the exposed F-type connector.

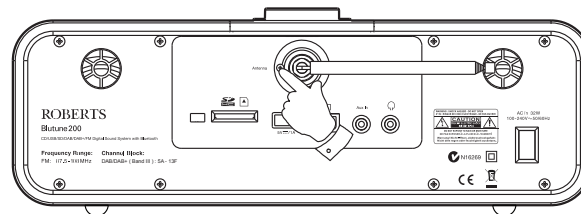

USB socket for smart-phone charging

In addition to playing and recording audio files, the USB socket on the rear panel of your sound system can be used for charging your smart-phone or tablet. It is intended to be used with the USB compatible charging lead that is generally supplied with such devices.

Note that the maximum charging current available is limited to 1 Amp. In addition, many devices use proprietary schemes to identify their chargers. This means that charging from the sound system may take longer than with the charger supplied by your device manufacturer. If your device fails to charge for this reason, it is not considered a fault of the sound system.

USB socket for software upgrades

In the event that any software update is made available for your sound system, information on how to update your sound system will be made available via our website at <http://www.robertsradio.com>

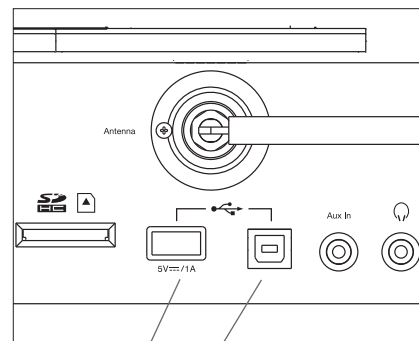

Charge outlet

Upgrade socket

Cautions

Do not allow this sound system to be exposed to water, steam or sand. Do not leave your sound system where excessive heat could cause damage.

It is recommended that the DAB band is used for radio listening where possible since this may result in better sound quality and freedom from interference than will often be obtained on the FM band.

The name plate is located on the rear of your sound system.



- The sound system shall not be exposed to dripping or splashing and that no objects filled with liquids, such as vases, shall be placed on the sound system.
- It is recommended to operate the product such that there is a minimum distance (10cm recommended) to adjacent objects in order to ensure good ventilation.
- The ventilation of the product should not be restricted by covering it or its ventilation openings with items such as newspapers, tablecloths, curtains etc.
- No naked flame sources such as lighted candles should be placed on the product.
- It is recommended to avoid using or storing the product at extremes of temperature. Avoid leaving the unit in cars, on window sills, in direct sunlight etc.
- The product must be used in a moderate climate.

Specifications

Power Requirements

Mains	100-240V ~ 50/60Hz (32W max)
Battery (Remote control)	1 x CR2032

Frequency Coverage

FM	87.5-108MHz
DAB	174.928 - 239.200MHz

Circuit features

Output Power	2 x 8 watts
Headphone socket	3.5mm dia
Auxiliary in socket	3.5mm dia

Aerial System	FM	Telescopic aerial
	DAB	Telescopic aerial

The Company reserves the right to amend the specification without notice.

Mains supply

The Blutune 200 will operate from a supply of 100-240V ~ 50/60Hz (32W max).

DO NOT cut off the mains plug from this equipment. If the plug fitted is not suitable for the power points in your home or the cable is too short to reach a power point, then obtain an appropriate safety approved extension lead or adaptor. If in doubt consult your dealer.

If nonetheless the mains plug is cut off, remove the fuse and dispose of the plug immediately to avoid a possible shock hazard by inadvertent connection to the mains supply.

If this product is not supplied with a mains plug, or one has to be fitted, then follow the instructions given below:

IMPORTANT. DO NOT make any connection to the larger terminal which is marked with the letter E or by the safety earth symbol \perp or coloured Green or Green-and-yellow.

The wires in the mains lead are coloured in accordance with the following codes :-

BLUE - NEUTRAL

BROWN - LIVE

The wire coloured BLUE must be connected to the terminal marked N or coloured BLACK.

The wire coloured BROWN must be connected to the terminal marked L or coloured RED.

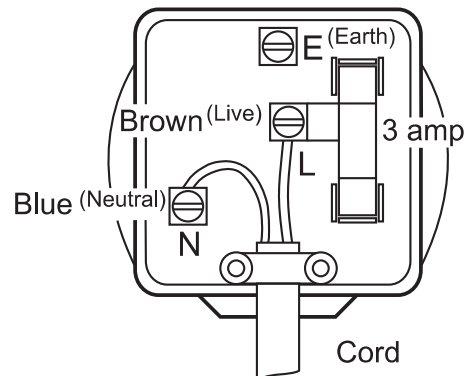

Fuse

When replacing the fuse only a 3A ASTA approved to BS1362 type should be used and be sure to re-fit the fuse cover.

IF IN DOUBT - CONSULT A QUALIFIED ELECTRICIAN.

This product is guaranteed for twenty four months from the date of purchase by the original owner against failure due to faulty workmanship or component breakdown, subject to the procedure stated below. Should any component or part fail during this guarantee period it will be repaired or replaced free of charge.

The guarantee does not cover:

1. Damage resulting from incorrect use.
2. Consequential damage.
3. Product with removed or defaced serial numbers.

N.B. Damaged or broken telescopic aerials will not be replaced under guarantee.

Procedure:

Any claim under this guarantee should be made through the dealer from whom the product was purchased. It is likely that your Roberts' dealer will be able to attend to any defect quickly and efficiently, but should it be necessary the dealer will return the product to the company's service department for attention. In the event that it is not possible to return the product to the Roberts dealer from whom it was purchased, please contact Roberts Radio using the contact details on the www.robertsradio.com website.

For product repairs falling outside the guarantee period, please refer to the "Customer care" tab on the www.robertsradio.com website.

These statements do not affect the statutory rights of a consumer.

ROBERTS RADIO LIMITED

PO Box 130
Mexborough
South Yorkshire
S64 8YT

Website: <http://www.robertsradio.com>

