

Sports DAB

DAB / FM personal digital radio with loudspeaker

ROBERTS

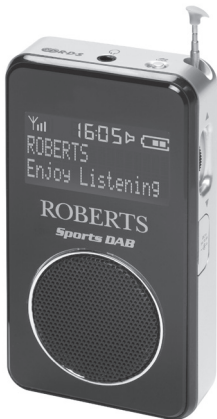

Please read this manual before use

DAB
Digital Audio Broadcasting

DAB+

+ Digital
Radio

Contents

<i>Controls</i>	3-4
<i>Using the AC adaptor</i>	5-6
<i>Keylock function</i>	7-8
<i>Navigation</i>	9-10
<i>Display icons</i>	11-12
<i>Operating your radio - DAB</i>	13-14
<i>Selecting a station - DAB</i>	15-16
<i>Display modes - DAB</i>	17-20
<i>Signal strength display - DAB</i>	21-22
<i>Finding new stations - DAB</i>	23-24
<i>Secondary services - DAB</i>	25-26
<i>Auto Select function - DAB</i>	27-28
<i>Manual tuning - DAB</i>	29-30
<i>Dynamic range control (DRC) settings - DAB</i>	31-32
<i>Operating your radio - Search tuning - FM</i>	33-34

<i>Manual tuning - FM</i>	35-36
<i>Display modes - FM</i>	37-38
<i>Preset stations DAB and FM</i>	39-42
<i>FM stereo/mono (Earphones only)</i>	43-44
<i>Software version</i>	45-46
<i>Contrast</i>	47-48
<i>Sleep function</i>	49-50
<i>Display backlight</i>	51-52
<i>Language</i>	53-54
<i>System reset</i>	55-56
<i>Earphones</i>	57-58
<i>General</i>	59-60
<i>Safety precautions</i>	61-62
<i>Specifications</i>	63
<i>Circuit features</i>	64
<i>Guarantee</i>	66

Controls

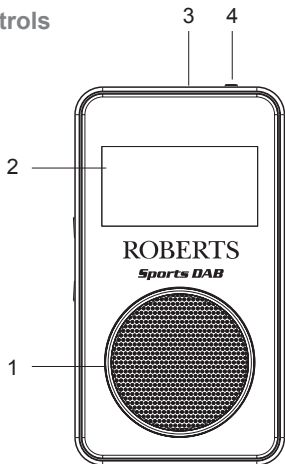

- 1. Loudspeaker
- 2. LCD display

- 3. Earphone socket
- 4. Lock switch

Controls

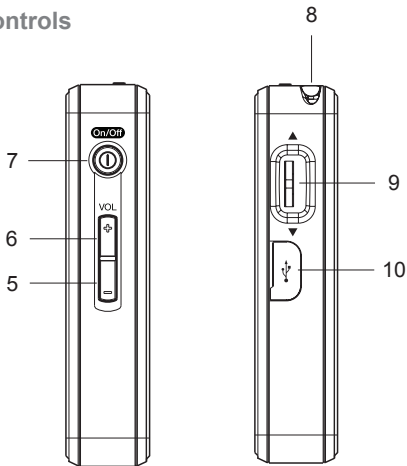



- 5. Volume down button
- 6. Volume up button
- 7. On/Off button

- 8. Telescopic aerial
- 9. Jog wheel
- 10. Charging socket

Using the AC adaptor

The **Sports DAB** features a built-in 1800mAH rechargeable Lithium battery to power your radio. Before operating the radio for the first time, ensure that you fully charge the radio.

1. Place your radio on a flat surface. Carefully pull back the protection cover and insert the adaptor plug into the **charging socket** on the right hand side of your radio.
2. Plug the adaptor into a standard mains socket and switch on the outlet. If the radio is switched on the battery indicator will become animated showing charging in progress.
3. The radio will begin charging the built-in battery. Charging time will take 4 hours with the radio switched off and 10 hours if the radio is switched on.
4. The battery power icon on the LCD display will flash whilst charging and stop flashing when the radio is fully charged . Reduced power, distortion, 'stuttering' sounds or the battery power indicator low  are all signs that the battery needs to be recharged.

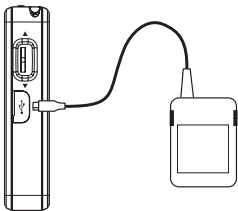

The AC adaptor should be disconnected from the mains supply and the radio when not in use.

IMPORTANT: The mains adaptor is used as the means of connecting the radio to the mains supply. The mains socket used for the radio must remain accessible during normal use. In order to disconnect the radio from the mains completely, the mains adaptor should be removed from the mains socket outlet completely.

Note: The mains adaptor which is supplied with your radio is a high efficiency type, designed to minimise energy consumption, whether the radio is playing, charging its battery or switched off. Do not use any other mains adaptor in place of the unit supplied. Such use will invalidate your guarantee.

Keylock function

The **Keylock function** is used to prevent unintentional operation of your radio.

1. Set the **Lock switch** located on the top of your radio to the 'Lock' position. If the radio is switched on 'Key Locked' will appear on the display. The On/Off and all other buttons will be disabled, this will prevent accidental operation when your radio is packed in a suitcase or travel bag.
2. To release the **Lock switch**, move the lock switch to the 'Unlock' position.

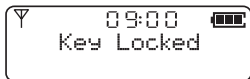
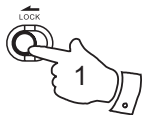

Navigation

This page describes the basic means of controlling your **Sports DAB**. Instructions for each operating mode are given in the later sections of this book.

1. Press and holding in the **Jog wheel** will access the main menus.
2. Many operations require the user to make a selection from the menus. Push the **Jog wheel** Up or Down to highlight the desired menu item and then click the **Jog wheel** to select that item. Arrows are used to show that there are more items in that menu.
3. If an error is made or you wish to go to the previous screen there is a "BACK" menu item in most menus. Push the **Jog wheel** Up or Down until "Back" is highlighted on the display and click the **Jog wheel** to select. After a period of inactivity the display will revert to the previous information display.

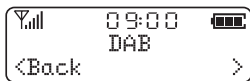
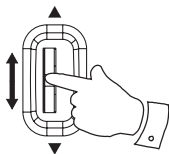

Display icons

- a. Signal strength indicator
- b. The time in 24 hour format
- c. Battery / Charge indicator

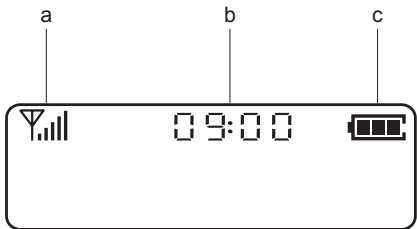

Operating your radio - DAB

1. Carefully extend the telescopic aerial.
2. Press the **On/Off button** to switch on your radio. The display will show "Welcome to Digital Radio".
3. If this is the first time the radio is used a scan of the Band III DAB channels will be carried out. If the radio has been used before the last used station will be selected.
4. During the scanning process, the lower line of the display shows a bar-graph indicating progress of the scan.
5. When the scanning is completed the first station (in numeric-alpha order 0...9...A...Z) will be selected. Your radio will automatically set to the current time.
6. If the station list is still empty after the scan your radio will display "No DAB Station" for 3 seconds then will display "Find Services".
7. If no signals are found it may be necessary to relocate your radio to a position giving better reception. Then, either switch your radio off and on again, or follow the procedure page 23 to repeat the scan.

On/Off



📶 00:00 🔋
Welcome to
Digital Radio

📶 09:00 🔋
Scanning... 24
■■■■■■■■■■□□□□□□

📶 09:00 🔋
BBC R2 DAB
Tuning...

📶 09:00 🔋
DAB
<Find Services >

Selecting a station - DAB

1. The top line of the display shows the name of the station currently selected.
2. Push the **Jog wheel** either up or down to scroll through the list of available stations on the lower line of the display. Stop when you find the station that you wish to hear.
3. Click the **Jog wheel** to select the station. The display may show "Tuning..." while your radio finds the new station.
4. Adjust the **Volume control** to the required setting.

Note: If after selecting a station the display shows "Service not available" it may be necessary to relocate your radio to a position giving better reception. The use of radio station presets for selecting your preferred radio stations is described on page 39.

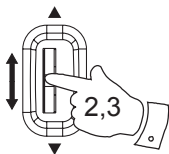

📶 09:00 🔋
Classic DAB
Classical music

📶 09:00 🔋
Station list
<BBC R2 >

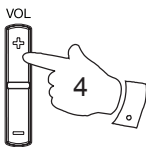

📶 09:00 🔋
BBC R2 DAB
Tuning...

Display modes - DAB

Your radio has a range of display modes:-

1. Click the ***Jog wheel*** to cycle through the various modes.
 - a. Scrolling text Displays scrolling text messages such as artist /track name, phone in number etc.
 - b. Program Type Displays the type of station being listened to e.g. Pop, Classic, News etc.
 - c. Multiplex Name Displays the name of DAB multiplex to which the current station belongs.
 - d. Time Displays the current time.
 - e. Date Displays the current date.

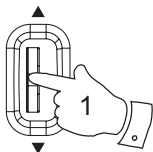

a

📶	09:00	🔋
BBC R2		DAB
Im sorry I have		

b

📶	09:00	🔋
BBC R2		DAB
Talk		

c

📶	09:00	🔋
BBC R2		DAB
BBC National DAB		

d

📶	09:00	🔋
BBC R2		DAB
09:00:12		

e

📶	09:00	🔋
BBC R2		DAB
9-6-2016		

Display modes - DAB cont.

- | | |
|--------------------------|-------------------------------------------------------------------------------|
| f. Frequency | Displays the frequency of the DAB multiplex for the station listened to. |
| g. Bit rate & audio type | Displays the digital bit rate & audio type for the station being listened to. |
| h. Signal Strength | Displays a graph showing the signal strength for the station being received. |

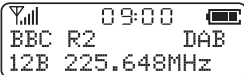
f 
BBC R2 DAB
12B 225.648MHz

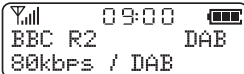
g 
BBC R2 DAB
80kbps / DAB

h 
BBC R2 DAB
■■■■■□■■■■■■□□□□□□

Signal strength display - DAB

1. Repeatedly click the ***Jog wheel*** until the lower line of the display shows signal strength.
2. Position your radio and try moving the aerial so as to give maximum number of black rectangles on the signal strength display. Normally, the best reception will be found with the aerial vertical and fully extended.
3. The clear unfilled rectangle indicates minimum signal level required for satisfactory reception.

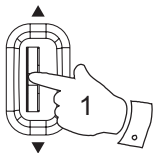

Finding new radio stations - DAB

As time passes new stations may become available. To find new stations proceed as follows:-

1. Press and hold the **Jog wheel**. The display will show "Find Services".
2. Click the **Jog wheel** and then push the **Jog wheel** up or down until the display shows "Scan".
3. Click the **Jog wheel**. The display will show "Scanning..." and your radio will perform a scan of the Band III DAB channels. As new radio stations are found the station counter on the right-hand side of the display will increase and the radio stations will be added to the list stored in the radio.

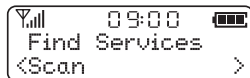
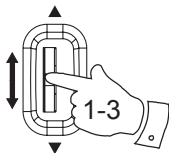

Secondary services - DAB

1. Certain radio stations have one or more secondary services associated with them. If a radio station has a secondary service associated with it the display will show ">>" next to the station name on the station list. The secondary service will then appear immediately after the primary service as you push the **Jog wheel** up or down.
2. Click the **Jog wheel** to select the station.
3. When the secondary service shuts down, your radio will automatically switch back to the main radio station (or primary service) if it is available.

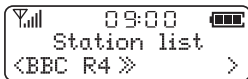
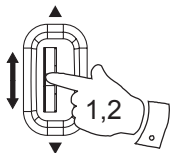

Auto select function - DAB

As an alternative to clicking the Jog wheel to select a station your radio can be set so as to automatically select a station.

1. Press and hold the **Jog wheel** the display will show "Find Services". Push the **Jog wheel** up or down until "Settings" is highlighted on the display.
2. Click the **Jog wheel** and then push the **Jog wheel** up or down until "Auto Select" shows on the display. Click the **Jog wheel** to confirm the selection.
3. Push the **Jog wheel** up or down until "YES" is highlighted. Click the **Jog wheel** to confirm selection. When tuning your radio it will now automatically select a station from the station list.
4. If you do not wish to use the Auto Select function press the **Jog wheel** up or down and choose "NO". The radio will require a click to choose a station from the station list.

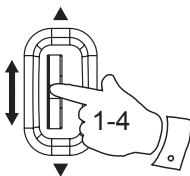

📶 09:00 🔋
DAB
<Settings >

📶 09:00 🔋
Settings
<Auto Select >

📶 09:00 🔋
Auto Select
NO <YES>

Manual Tuning - DAB

Manual tuning allows you to tune directly to the various DAB Band III channels.

1. Press and hold in the **Jog wheel** until the display shows "Find Services". Click the **Jog wheel** to enter the Services menu.
2. Push the **Jog wheel** up or down until the display shows "Manual tune". Click the **Jog wheel** to select this function.
3. Push the **Jog wheel** up or down to highlight the desired channel.
4. Click the **Jog wheel**. The graph will indicate the signal strength, and the upper line will show the name of the DAB Multiplex (group of radio stations). Any stations found will be added to the stored list in the radio.
5. Click the **Jog wheel** to return to the normal tuning mode.

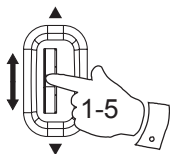

📶 09:00 🔋
DAB
<Find Services >

📶 09:00 🔋
Find Services
<Manual tune >

📶 09:00 🔋
Manual tune
<5A 174.928MHz >

📶 09:00 🔋
11D 222.064MHz
■■■■■▣■■■■■■■■■■■■■■■■■■

📶 09:00 🔋
Classic DAB
Tuning...

Dynamic Range Control settings - DAB

Dynamic Range Control (also known as DRC) can make quieter sounds easier to hear when your radio is used in a noisy environment.

1. Press the **On/Off button** to switch on your radio.
2. Press and hold in the **Jog wheel**. The display will show "Find Services."
3. Push the **Jog wheel** up or down until the display shows "Settings". Click the **Jog wheel** to enter the settings menu.
4. Push the **Jog wheel** up or down until "DRC" is highlighted.
5. Click the **Jog wheel** to enter the adjustment mode.
6. Push the **Jog wheel** up or down to select the required DRC setting (the default is off).

DRC off - DRC is switched off, Broadcast DRC will be ignored. DRC low - DRC level is set to 1/2 that sent by broadcaster. DRC high - DRC level is used as sent by broadcaster.

7. Click the **Jog wheel** to confirm the setting. The display will return to the previous display.

On/Off

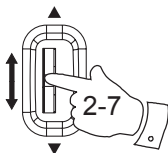

Note: Not all DAB broadcasts are able to use the DRC function. If the broadcast does not support DRC, then the DRC setting in the radio will have no effect.

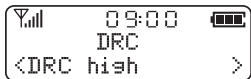
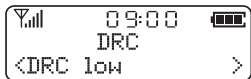
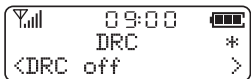
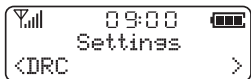
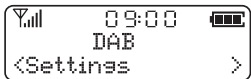

Operating your radio - Search tuning - FM

1. Carefully extend the telescopic aerial fully and press the **On/Off button** to switch on your radio.
2. Press and hold the **Jog wheel** the display will show "Find Services". Push the **Jog wheel** up or down until "FM mode" is highlighted.
3. Click the **Jog wheel** to enter FM mode.
4. Push the **Jog wheel** up and hold for 2 seconds, your radio will scan in an upwards direction (low frequency to high frequency) and stop automatically when it finds a station of sufficient strength.
5. After a few seconds the display will update. The display will show the frequency of the signal found. If the signal is strong enough and there is RDS data present then the radio will display the station name.
6. To find other stations, push the **Jog wheel** up and hold as before.
7. To scan the FM band in a downwards direction (high frequency to low frequency) push the **Jog wheel** down and hold for 2 seconds.

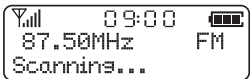
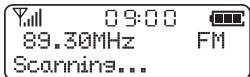
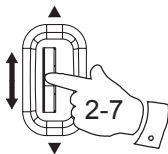
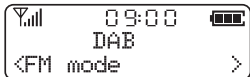

- When the waveband end is reached your radio will recommence tuning from the opposite waveband end. Adjust the **Volume control** to the required setting.

The use of radio station presets for selecting your preferred radio stations is described on page 39.

Manual tuning - FM

1. Carefully extend the telescopic aerial fully for FM reception. Press the **On/Off button** to switch on your radio.
2. Select FM mode as previously described if required.
3. Push the **Jog wheel** up or down to tune to a station. With each push of the **Jog wheel** the frequency will change up or down by 50 kHz.
4. When the waveband end is reached the radio will recommence tuning from the opposite waveband end.
5. Set the **Volume control** to the desired settings.
6. To switch off your radio press the **On/Off button**.

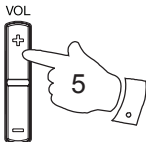
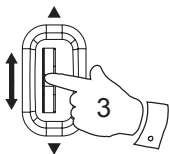
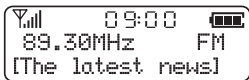

Display modes - FM

In FM mode the bottom line of the display can be set to any of the following display options:-

1. Click the **Jog wheel** to cycle through each of the options.
 - a. Scrolling text Displays scrolling text such as artist name, phone in number, etc.
 - b. Program type Displays type of station being listened to e.g. Pop, Classic, News, etc.
 - c. Audio mode Display shows stereo or Mono.
 - d. Time Displays the current time.
 - e. Date Displays the current date.
 - f. Frequency Displays the FM frequency

Note: Your radio will display "NO Radio Text" on the lower line of the display if there is no scrolling text available and "NO PTY" if there is no programme type information.

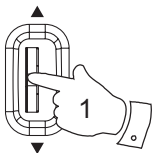

a

📶	09:00	🔋
BBC R2		FM
The latest news		

b

📶	09:00	🔋
BBC R2		FM
Pop music		

c

📶	09:00	🔋
BBC R2		FM
Mono		

d

📶	09:00	🔋
BBC R2		FM
09:00:02		

e

📶	09:00	🔋
BBC R2		FM
9-6-2016		

f

📶	09:00	🔋
BBC R2		FM
90.10MHz		

Presetting stations

You may store your preferred DAB and FM radio stations to the preset station memories. There are 20 memory presets in your radio, 10 for DAB and 10 for FM. Presets are remembered by your radio in the event of a power failure.

The procedure for setting presets and using them to tune stations is the same for FM and DAB modes, and is described below.

1. Press the **On/Off button** to switch on the radio.
2. Select the desired waveband.
3. Tune to the required station as previously described.
4. Press and hold the **Jog wheel** to enter the menu and then push up or down until "Favourites" is highlighted. Click the **Jog wheel** to select this function.
5. Push the **Jog wheel** up or down until the display shows "Preset Store" then click.
6. Push the **Jog wheel** up or down to select the desired preset number under which you wish to store the station.

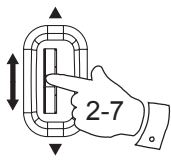
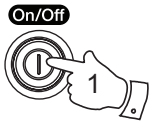

7. Press and hold the **Jog wheel** until the display shows, for example, "Preset 1 stored". The station will be stored under the chosen preset. Repeat this procedure as needed.
8. Stations which have been stored in preset memories may be overwritten by following the above procedure.

Recalling a preset

1. Press the **On/Off button** to switch on the radio.
2. Select the required waveband as previously described.
3. Press and hold the **Jog wheel** to enter the menu and then push up or down until "Favourites" is highlighted. Click the **Jog wheel** to select this function.
4. Push the **Jog wheel** up or down until the display shows "Preset Recall" then click.
5. Push the **Jog wheel** up or down to highlight the desired preset station.
6. Click the **Jog wheel** to tune to the station stored in preset memory.

Note: If you have not previously stored a preset station and the preset button is pressed "Empty preset" will be displayed.

On/Off

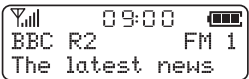
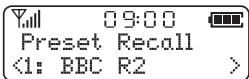
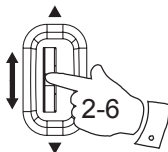
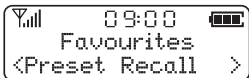
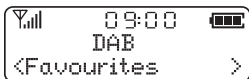

FM Stereo/Mono (Earphones only)

If a station being received is weak some hiss may be audible (especially when listening using earphones).

1. To reduce the hiss press and hold the **Jog wheel** to enter the menu and then push up or down until "Settings" is highlighted. Click the **Jog wheel** to select this function.
2. Push the **Jog wheel** up or down until the display shows "Audio setting" then click the **Jog wheel**.
3. Push the **Jog wheel** up or down until "Forced mono" is displayed. Click the **Jog wheel** to select mono. Your radio will select the mono audio mode.
4. To return to stereo mode push the **Jog wheel** up or down until the display shows "Audio setting" then click the **Jog wheel**.
5. Push the **Jog wheel** up or down until "Stereo allowed" is displayed. Click the **Jog wheel** your radio will switch to stereo mode. The chosen setting will be marked with an asterisk.

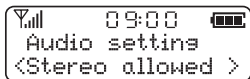
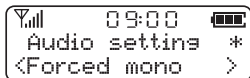
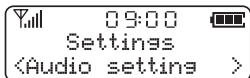
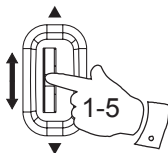

Note: Stereo listening is only available when listening via earphones.

Software version

The software display cannot be altered and is just for your reference.

1. To view the software version press and hold the **Jog wheel** to enter the menu and then push up or down until "Settings" is highlighted on the display.
2. Click the **Jog wheel** and then push up or down until "SW version" shows on the display.
3. Click the **Jog wheel** the software version will appear on the display.

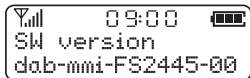
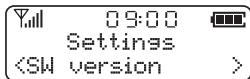
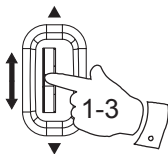

Contrast

The contrast of the display can be adjusted on your radio.

1. To adjust the contrast press and hold the **Jog wheel** to enter the menu and then push up or down until "Settings" is highlighted on the display.
2. Click the **Jog wheel** and then push up or down until "Set Contrast" shows on the display.
3. Click the **Jog wheel** to enter adjustment mode.
4. Push the **Jog wheel** up or down to adjust the contrast level (between 1 and 10). The contrast level indication on the screen will change at the same time. When you find the setting that gives you the best legibility for the location in which the radio is used, click the **Jog wheel** to save the setting.

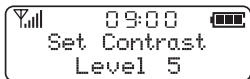
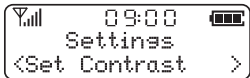
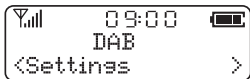
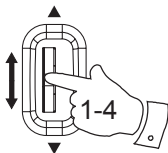

Sleep function

Your radio can be set to turn off after a preset time has elapsed. The sleep setting can be adjusted between 15 and 90 minutes. Ensure your radio is switched on.

1. Press and hold the **Jog wheel** to enter the menu and then push up or down until "Settings" is highlighted on the display.
2. Click the **Jog wheel** and then push up or down until "Sleep" is highlighted on the display.
3. Click the **Jog wheel** to enter adjustment mode.
4. Push the **Jog wheel** up or down to set the desired sleep time between 15 and 90 minutes or OFF which will cancel the sleep function.
5. Click the **Jog wheel** to confirm the setting. The sleep timer indicator  will show on the display. Your radio will switch off after the preset sleep time has elapsed.
6. To cancel the sleep timer and switch off your radio before the chosen sleep time has elapsed, press the **On/Off button**.

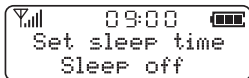
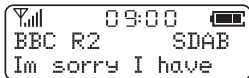
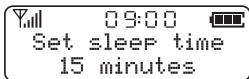
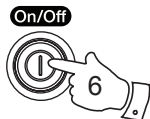
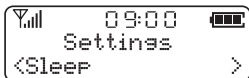
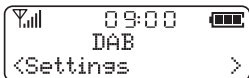
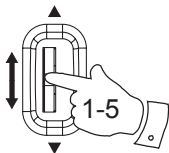

To cancel the sleep timer without switching off your radio, set the desired sleep time to OFF.

Display backlight

The display backlight can either be left on whilst the radio is in use or can be set to automatically switch on for just approximately 12 seconds when any button is pressed.

1. To set the backlight to automatically switch off after 12 seconds press and hold the **Jog wheel** to enter the menu and then push up or down until "Settings" is highlighted on the display.
2. Click the **Jog wheel** to enter the Settings menu.
3. Push the **Jog wheel** up or down until "Set backlight" is highlighted on the display.
4. Click the **Jog wheel** and push up or down until "YES" is highlighted. Click the **Jog wheel** to confirm selection. The backlight will now switch on for just 12 seconds. The radio will return to the normal radio mode.
5. If you require the backlight to be on continuously push the **Jog wheel** up or down and choose "NO". The radio will return to the normal radio mode.

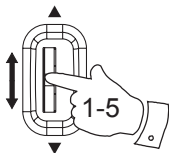

Signal strength icon | 09:00 | Battery icon
DAB
<Settings >

Signal strength icon | 09:00 | Battery icon
Settings
<Set backlight >

Signal strength icon | 09:00 | Battery icon
Backlight Auto
NO <YES>

Language

Your radio's menu may be configured to a different language.

1. Press and hold the ***Jog wheel*** to enter the menu and then push up or down until "Settings" is highlighted on the display.
2. Click the ***Jog wheel*** to enter the Settings menu.
3. Push the ***Jog wheel*** up or down until "Language" is highlighted on the display.
4. Click the ***Jog wheel*** and push up or down until your desired language appears on the display.
5. Click the ***Jog wheel*** to confirm your choice. The display will change to the chosen language.

The chosen language will be marked with an asterisk.

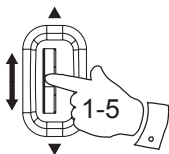

Signal strength icon 09:00 Battery icon
DAB
<Settings >

Signal strength icon 09:00 Battery icon
Settings
<Language >

Signal strength icon 09:00 Battery icon
Language *
<English >

System reset

If your radio fails to operate correctly, or some digits on the display are missing or incomplete, it may be possible to restore normal operation by carrying out a System Reset operation on your radio. This will restore the radio's settings to their factory defaults. No presets will be stored, and the list of DAB radio stations will be empty.

If you have moved to a different part of the country and you wish to erase local DAB radio stations that are no longer available from the stored list, then you may carry out this procedure. Your radio will automatically re-scan for the DAB stations available at your current location when it restarts.

1. Press and hold the ***Jog wheel*** to enter the menu.
2. Push the ***Jog wheel*** up or down until the display shows "Settings", then click the ***Jog wheel*** to enter the settings menu.
3. Push the ***Jog wheel*** up or down until the display shows "Factory Reset". Click the ***Jog wheel***.
4. If you wish to perform the reset operation, push the ***Jog wheel*** up or down until "YES" is highlighted on the display and click. A full reset of your radio will be performed. All presets and station lists will be erased.

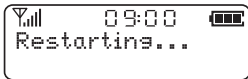
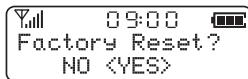
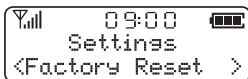
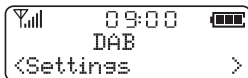
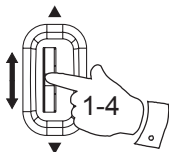

If you do not wish to reset your radio push the **Jog wheel** up or down until "NO" is highlighted. Your radio will return to the previous menu.

5. After a system reset a scan of the DAB band will be performed.

In case of malfunction due to electrostatic discharge, reset the product (temporary disconnection of the power adaptor may be required) to resume normal operation.

Earphones

The lead connecting the earphones to your radio acts as an aerial when plugged into the **Earphone socket**. The lead should be extended as much as possible to increase reception.

Note: When using earphones it is normally not necessary to extend the telescopic aerial.

1. Plug the earphones into the **Earphone socket** on the top of your radio.
2. Check that the **Volume level** is not too loud before placing the ear-pieces into your ears.

IMPORTANT: Do not switch on the radio with the earphones connected and inserted in your ear. Excessive sound pressure from earphones can cause hearing loss.



To prevent possible hearing damage, do not listen at high volume levels for long periods.

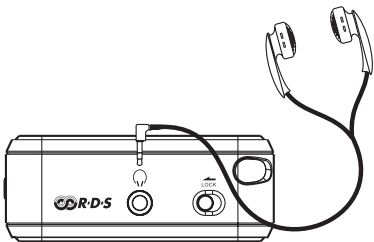

General

Do not allow this radio to be exposed to water, steam or sand. Do not leave your radio where excessive heat could cause damage such as in a parked car where the heat from the sun can build up even though the outside temperature may not seem too high. It is recommended that the DAB band be used wherever possible as better results in terms of quality and freedom from interference will usually be obtained than on the FM band.

The name plate is located on the rear of your radio.



- Your AC/DC adaptor and radio should not be exposed to dripping or splashing and that no objects filled with liquids, such as vases, shall be placed on the AC/DC adaptor or the radio.
- It is recommended to operate the product such that there is a minimum distance (10cm recommended) to adjacent objects in order to ensure good ventilation.
- The ventilation of the product should not be restricted by covering it with items such as newspapers, tablecloths, curtains etc.
- No naked flame sources such as lighted candles should be placed on the product.
- It is recommended to avoid using or storing the product at extremes of temperature. Avoid leaving the unit in cars, on window sills, in direct sunlight etc.
- The product must be used in a moderate climate.

Safety precautions

There are no user serviceable parts inside this product.

Do not attempt to disassemble any part of the product.

Do not use or charge the battery if it appears to be abnormally hot, swollen, leaking or damaged in any way.

Do not leave a charging battery unattended.

If the product is supplied with a charger, then the product should only be used with that charger, or a genuine replacement provided by Roberts Radio. Do not use any alternative power source as a charger.

Check the room temperature range is between 0-40°C (32-104°F) before charging the product/ battery.

Do not puncture, crush, modify, or cause any unnecessary shock to the battery. The battery may present a risk of fire, explosion or chemical burn if mistreated.

Do not dispose of the battery in a fire or incinerator.

Do not leave, charge or expose the battery to a heat source such as in a car under direct sunlight.

Do not expose the battery to moisture.

Specifications

Power Requirement Mains (via adaptor)
AC 100 \sim 240V 50/60Hz DC 5V 500 mA

Lithium rechargeable battery 3.7V

Battery life full charge

Up to 30 hours depending on volume and operating mode.

Frequency Coverage

FM 87.5-108MHz, DAB 174.928 -239.200MHz

Circuit Features

Loudspeaker 36mm

Output Power 150 mW (Speaker)

Earphone socket 3.5mm dia. stereo

Aerial System	FM	Telescopic aerial
	DAB	Telescopic aerial

The Company reserves the right to amend the specification without notice.

Guarantee

This product is guaranteed for twenty four months from the date of purchase by the original owner against failure due to faulty workmanship or component breakdown, subject to the procedure stated below. Should any component or part fail during this guarantee period it will be repaired or replaced free of charge. The guarantee does not cover:

1. Damage resulting from incorrect use.
2. Consequential damage.
3. Product with removed or defaced serial numbers.

N.B. Damaged or broken telescopic aerials will not be replaced under guarantee.

Procedure: Any claim under this guarantee should be made through the dealer from whom the product was purchased. It is likely that your Roberts dealer will be able to attend to any defect quickly and efficiently, but should it be necessary the dealer will return the product to the company's service department for attention. In the event that it is not possible to return the product to the Roberts dealer from whom it was purchased, please contact Roberts Radio using the contact details on the www.robertsradio.com website.

For product repairs falling outside the guarantee period, please refer to the "customer care" tab on the www.robertsradio.com website. These statements do not affect the statutory rights of a consumer.

ROBERTS RADIO LIMITED

PO Box 130
Mexborough
South Yorkshire
S64 8YT



Website: <http://www.robertsradio.com>

© 2016 Roberts Radio Limited

Issue 2