

ROBERTS

Reassuringly Roberts

STREAM 64i

CD/DAB/FM RDS/WiFi Internet Radio with dock for iPod



DAB

Digital Audio Broadcasting

Please read this manual before use

iPod is a trademark of Apple Inc., registered in the U.S. and other countries.

"Made for iPod" means that an electrical accessory has been designed to connect specifically to iPod and has been certified by the developer to meet Apple performance standards.

Apple is not responsible for the operation of the device or its compliance with safety and regulatory standards.

Contents

Introduction	2-12	CD / MP3 / WMA	62-70
Stream 64i Internet radio features.....	3	Compact discs.....	62
Before you can use this product.....	4	Playing a CD.....	63-65
About this instruction manual.....	5-6	CD track programming.....	66
Controls and connections.....	7-8	CD / MP3 / WMA mode.....	67-70
Remote control operation.....	9-10	SD / USB playback and recording	71-79
Navigation controls.....	11-12	SD/USB file and folder selection.....	72-74
Network configuration	13-21	Recording to SD/USB.....	75-77
Connecting your radio to your computer network.....	13-21	Deleting files.....	78-79
Internet Radio mode	22-35	iPod docking	80-82
Internet Radio - the basics.....	22	Navigating your iPod.....	80-82
Selecting a radio station by location and genre.....	23-25	Clock and Alarms	83-91
Searching for a radio station by name.....	26	Automatically updating the clock.....	83
Selecting a new or popular station.....	27	Manually setting the clock.....	85-86
Selecting a podcast / BBC Listen Again.....	28	Setting the alarm clock.....	87-90
Presetting stations.....	29	Sleep timer.....	91
Display modes.....	30-31	Display and Audio	92-99
Customising your radio.....	32-33	Equaliser.....	92
Selecting favourite stations.....	34	Brightness control.....	94
Music Player mode	36-46	Touch sensitivity control panel.....	96
Use with Windows, Apple Mac and Linux.....	36	Headphone socket and Line out socket.....	97
Accessing your files via UPnP.....	37-38	Auxiliary input socket.....	98
Locating and playing media files using UPnP.....	39	Information	100-114
Media selection.....	40	Factory reset.....	100
Controlling playback.....	41-42	Software update.....	101
Display modes.....	43	Network profiles.....	102
Playlists.....	44-46	Audio FAQ.....	103
DAB mode	47-55	Troubleshooting.....	104-105
Selecting a DAB radio station.....	48	Audio codecs.....	108
Display modes.....	49-50	Cautions and Specifications.....	109-110
Finding new DAB radio stations.....	51	Mains supply.....	111
Station order setup.....	54	Guarantee.....	114
FM mode	56-61		
Manual tuning.....	57		
Scan setting.....	59		
Stereo / Mono switching.....	60		
Presetting stations in DAB and FM modes.....	61		

Introduction

Stream 64i Internet Radio features

The Roberts Stream 64i provides the following features in an attractive compact unit:-

- Listen to local, regional, national and international broadcasts using FM, DAB and Internet radio. Listen to over 1000 radio stations from around the country, and over 10,000 from around the world without using your PC.
- Listen to previously broadcast material from the BBC (using Listen Again)
- Listen to podcasts from a wide range of broadcasters.
- 30 radio station presets (10 Internet Radio, 10 DAB and 10 FM).
- Use the Music Player to play your music collection from your computer (using Windows Media Player 11 or 12). Connection to Apple and Linux based computers is also possible.
- Plays MP3, WMA, AAC, FLAC, WAV and Real Audio formats (Real Audio for Internet Radio only; CD, USB and SD play MP3 and WMA files only).
- Play from CD, USB memory and SD cards (including MP3 and WMA files from CD).
- Play from iPod (iPhone and iPod touch also supported). Charges your iPod when docked.
- Record CD or radio to USB memory and SD cards.
- The Stream 64i connects to your home computer network, either using WiFi or via a wired Ethernet connection. WiFi Protected Setup (WPS) is supported with compatible wireless routers.
- All radio station presets, network configuration details and user settings are retained in the event of a power failure.
- Large clock display with time and date when in Standby.
- Two alarm timers with snooze feature to wake you to radio, CD, USB, SD card, iPod or buzzer alarm.
- Adjustable sleep timer, can be set to turn the radio off between 15 and 120 minutes.
- Easy-to-read graphic display with adjustable display backlight.
- Easy to use, wipe clean, touch sensitive control panel.
- Auxiliary input for playing audio from MP3 players, iPods or other audio equipment.
- A standard 3.5mm Line Output socket for connecting the audio signal to an external amplifier or recorder.
- A standard 3.5mm headphone socket for private listening.
- High quality stereo speaker system in an acoustically tuned piano gloss cabinet.

Before you can use this product

Before you can use your internet radio, you must have the following:

- A broadband Internet connection (not required for DAB, FM or Music Player functions).
- A wireless access point (WiFi) or a wired Ethernet connection connected to your broadband Internet Service Provider, preferably via a router. In many cases the broadband modem, router and wireless access point will be a single combined unit supplied by your Internet Service Provider or bought from a computer store.
- If your wireless network is configured to use Wired Equivalent Privacy (WEP) or WiFi Protected Access (WPA/WPA2) data encryption then you either need to know the WEP, WPA or WPA2 key used for encryption so you can get the internet radio to communicate with the network, or your router needs to offer WiFi Protected Setup (WPS).

If connecting using WiFi, the internet radio will typically work within a 10-20 metre radius from your wireless access point. The actual range achieved will depend upon the building type, other nearby wireless networks, and possible interference sources. DAB and FM radio functions can operate wherever the internet radio is able to receive a suitable broadcast signal.

IMPORTANT: Before you continue, make sure that your wireless access point or router is powered up and working with your broadband Internet service (use your computer to verify this). To get this part of the system working you must read the instructions supplied with the wireless access point or router.

About this instruction manual

This instruction manual is divided into sections for each of the operating modes of your Roberts Stream 64i internet radio. Each section is identified by the shaded heading in the top right hand corner of each pair of pages.

Before using the Internet Radio or Music Player functions, you will need to connect your radio to your computer network using either the WiFi or Ethernet connection. This is covered in the section titled **Configuration**.

The **Internet Radio** section describes how to find radio stations to listen to. These can be radio stations that you already know and listen to conventionally, or new stations that you search for. You may set up stations that you like as Favourites so that they are more readily accessible.

The section for the **Music Player** describes how you may play music files that you may have stored on a computer connected to your network. The use of Shared Media (using UPnP) is explained.

The section for **DAB Radio** describes how to use the radio to listen to conventional DAB radio broadcasts.

The section for **FM Radio** describes how to use the radio to listen to conventional FM radio broadcasts.

Configuration

(page 13)

Internet Radio

(page 22)

Music Player

(page 36)

DAB Radio

(page 47)

FM Radio

(page 56)

The section for **CD / MP3 / WMA player** describes how to play digital audio or MP3 / WMA files which have previously been recorded to CD-R or CD-RW.

The section for **SD / USB media** describes playback and recording using SD card and USB memory devices.

The section for **iPod docking** describes how to use your Stream 64i to play audio files or video soundtracks directly from your iPod.

The section titled **Clock** and **Alarms** describes the different ways by which the clock in the radio may be set, as well as explaining the use of the alarms, snooze and sleep timer features.

The **Display** and **Audio** section shows how to adjust the display, use the equaliser and connect your internet radio to other audio equipment.

The **Information** section includes troubleshooting, specifications and warranty information.

CD / MP3 / WMA

(page 62)

SD / USB

(page 71)

iPod Docking

(page 80)

Clock and Alarms

(page 83)

Display and Audio

(page 92)

Information

(page 100)

Controls and connections

Front view

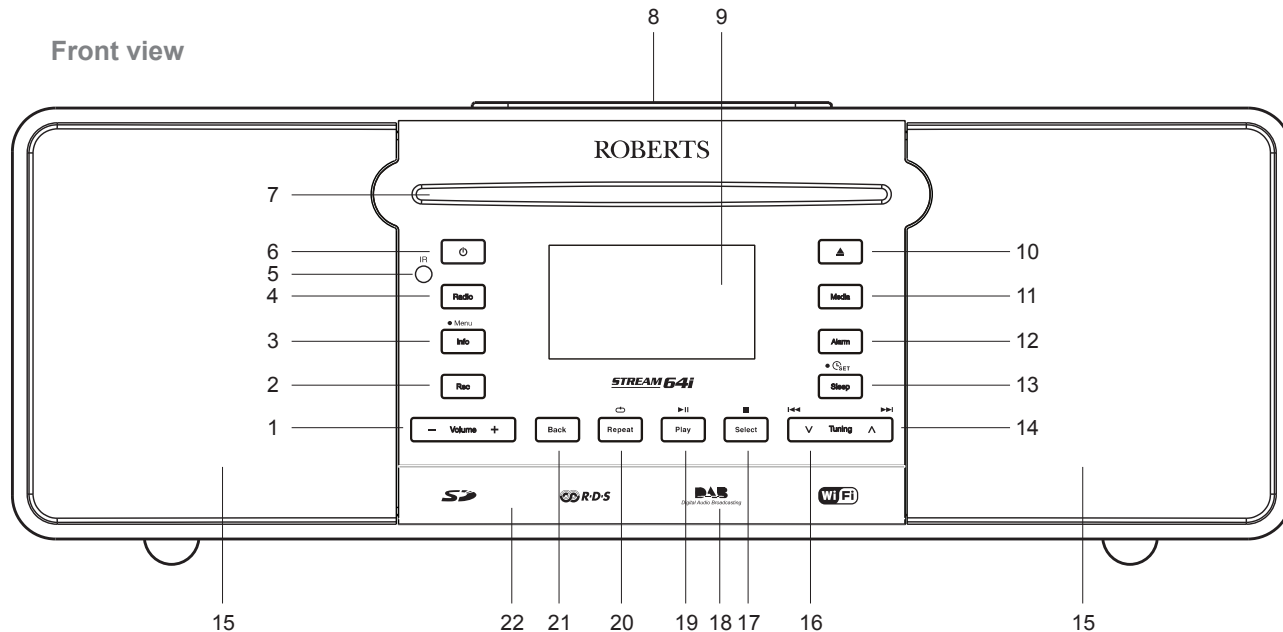

1. Volume Up / Down buttons
2. Record button
3. Info / Menu button
4. Radio button
5. Remote control sensor
6. On / Standby button
7. CD slot
8. iPod dock connector

9. LCD display
10. CD Eject button
11. Media button
12. Alarm button
13. Sleep / Clock set button
14. Menu Up / Fast-forward button
15. Loudspeakers x 2

16. Menu Down / Rewind button
17. Select / Stop button
18. USB memory socket (behind panel)
19. Play / Pause button
20. Repeat button
21. Back button
22. SD card slot (behind panel)

Rear view

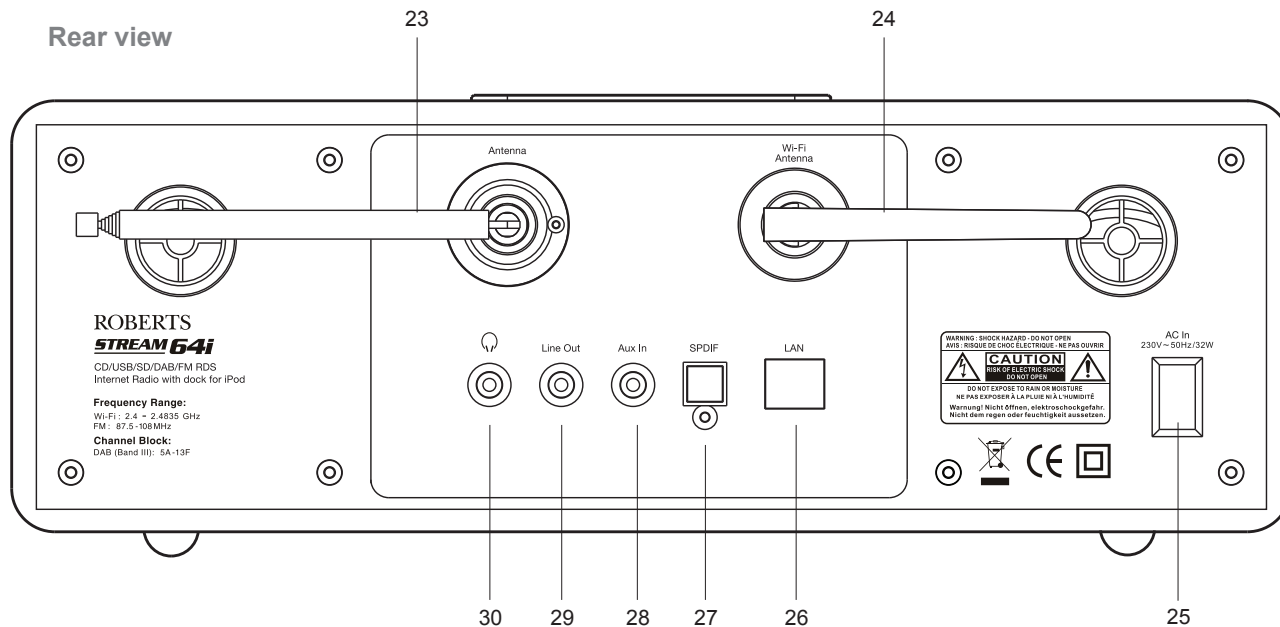

23. Telescopic aerial

24. Wi-Fi antenna

25. Mains input socket

26. Ethernet socket (RJ-45)

27. Optical output socket (Toslink)

28. Auxiliary input socket

29. Line output socket

30. Headphone socket

Controls and connections - cont.

Remote control handset

1. On / Standby button
2. Mute button
3. Key pad buttons 1-10/0
4. Menu Up / Folder Up button
5. Menu Left / Rewind button
6. Info / Menu button
7. Record button
8. Media button
9. Sleep / Clock set button
10. Repeat button
11. Equaliser button
12. Random button
13. Alarm button
14. Radio button
15. Auto-tune / Program tracks button
16. Play / Pause button
17. Menu Down / Folder Down button
18. Menu Right / Fast-forward button
19. Select / Stop button
20. Back button
21. Volume Up / Down buttons
22. CD eject button

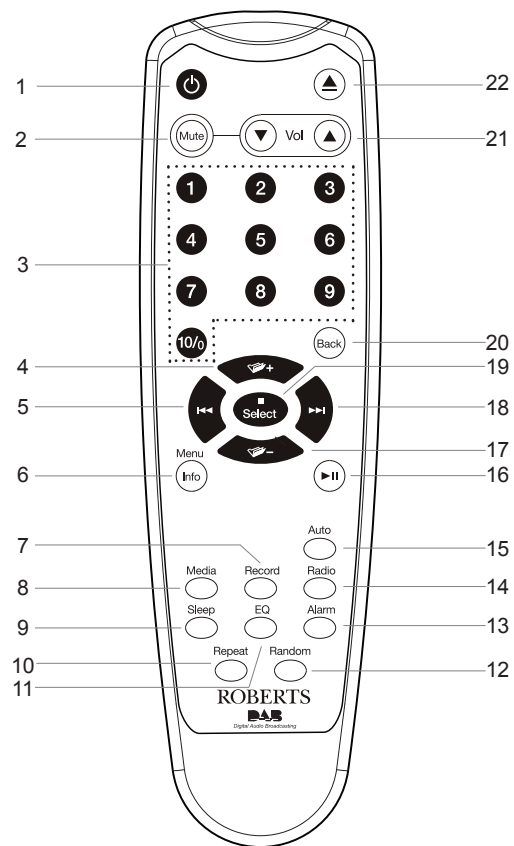

Remote control battery replacement

1. Remove the battery cover on the rear of your remote control by applying pressure to the catch in the direction shown by the arrow in the diagram, and then lifting the cover.
2. Insert 2 x AAA size batteries into the compartment. Make sure the (+) and the (-) ends of the batteries are positioned as shown inside the compartment.
3. Close the battery cover by inserting the retaining lugs first, then apply pressure to the free end such that the catch latches the cover securely.
4. If the remote is not to be used for an extended period of time it is recommended that the batteries are removed.

IMPORTANT: The batteries should not be exposed to excessive heat such as sunshine, fire or the like. After use, disposable batteries should if possible be taken to a suitable recycling centre. On no account should batteries be disposed of by incineration.

Do not leave batteries within reach of young children. They can be a choking hazard.

1. Battery compartment
2. Latch
3. Retaining lugs (inside)

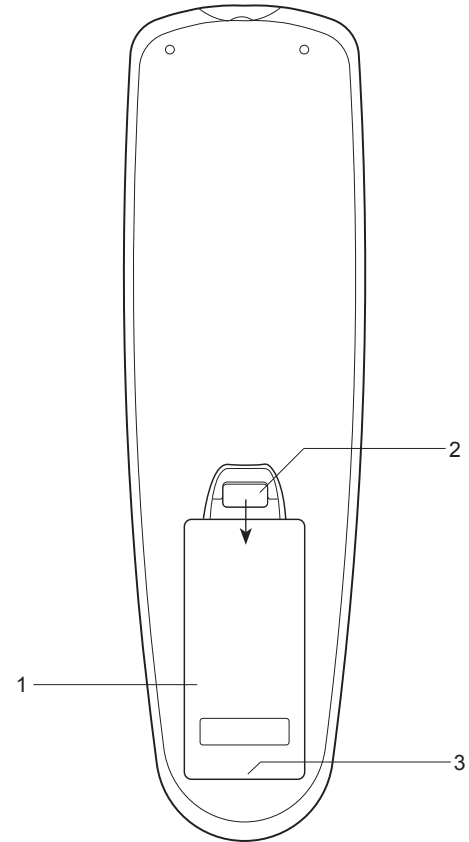

Using the touch panel

The Stream 64i has a stylish touch panel instead of conventional buttons.

To operate the buttons simply touch the button area with the tip of a finger for about half a second. The clock set and system menu functions marked with a dot (●) are accessed by means of a long touch (2-3 seconds) on the appropriate button until the display on the radio shows that the command has been accepted.

You may find at first that the radio does not always detect that you have touched a button. If so, try touching with a little more pressure, or for slightly longer. You will soon find the optimum touch needed to control your radio. (See also Touch Panel Sensitivity Control on page 96.)

The panel may be cleaned using a dry cloth. Do not use abrasives, cleaning fluids or solvents.

Remote control functions

Most of the functions of the Stream 64i radio can be controlled using either the touch panel or the remote control. However, there are a few functions which are only accessible using the remote control. These are:

Radio station presets	DAB / FM auto-tune
CD track access by numbers	CD / iPod random function
Audio mute	

As with the front panel, some operations require a longer operation of the button (explained in the relevant sections). In this case simply keep your finger held on the remote control button for 2-3 seconds until the display on the radio shows that the command has been accepted.

Navigation controls

This page describes the basic means of controlling your Stream 64i internet radio. Instructions for each operating mode are given in the later sections of this book.

- Pressing the **On/Standby** button brings your radio out of Standby mode.
Pressing **On/Standby** while the radio is in use will cause it to return to the Standby mode with the clock display.
- Pressing the **Radio** button gives you access to each of the operating modes in turn: Internet Radio, DAB radio, FM radio and Auxiliary Input.
- Pressing the **Media** button gives you access to each of the operating modes in turn: CD, USB memory device, SD card, iPod, and Music player.
- Pressing and holding the **Info/Menu** button will access the menu system. The **info** button also allows the display of information relating to the radio station or music file being played.
- Many operations require the user to make a selection from the menu. Highlight the menu item using the **Menu Up** or **Down** buttons. Press the **Select** button to select that item. If there are more than five items in a menu, then the display will automatically scroll up or down so that the additional items become visible. A sliding bar on the right will give an indication showing the current portion of the menu that is displayed.
If there are many items in a menu, then the radio allows the menu to 'wrap around' in either direction. This can make it easier to reach items at the end of a long menu, such as a list of countries or Internet radio stations.
- If an error is made when navigating the menus, it is generally possible to go back to a higher level menu by pressing the **Back** button.

Although controls on the internet radio are shown, all functions are also available using the remote control.

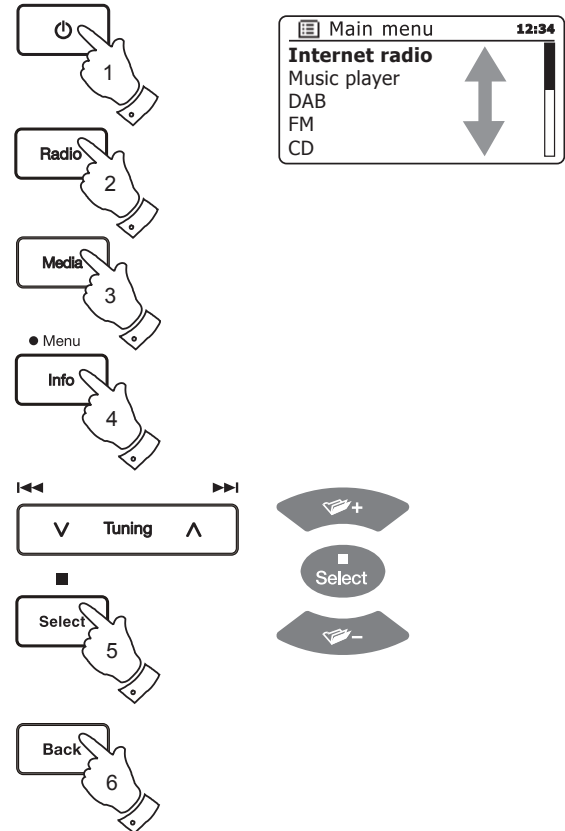

Configuration

Connecting your radio to your computer network

1. Place your radio on a flat surface and plug the mains lead into the mains socket located on the back of your radio ensuring that the plug is pushed fully into the socket.
2. If you wish to use a wired network connection, plug the Ethernet cable into the RJ-45 socket (marked LAN) at the back of the radio.
3. Plug the other end of the mains lead into the wall socket and switch on the wall socket.

IMPORTANT: The mains plug is used as the means of connecting the radio to the mains supply. The mains socket used for the radio must remain accessible during normal use. In order to disconnect the radio from the mains completely, the mains plug should be removed from the mains socket outlet completely.

4. When you apply power, the display on the radio will light up and say: 'WELCOME' and 'STARTING' with a progress indicator. The first time that you use your radio (or after a Factory Reset) the display will show 'Setup wizard' and 'YES' will be highlighted on the screen. Press the **Select** button to start the setup wizard. You will then have a choice to set the clock to use the 12 or 24 hour format.

You are recommended to run the setup wizard, but if you do not wish to then press the **Menu Up** or **Down** buttons until 'NO' is highlighted on the display then press the **Select** button. The screen will ask if you wish to run the setup wizard again at the next start up. This will lead to the main menu.

5. Press the **Menu Up** or **Down** buttons to highlight the desired clock format (either 12 or 24 hour) then press the **Select** button to enter your selection. A menu allowing you to specify the auto update option for the clock will appear on the display. The default of 'Update from Network' will be the best option for most users.

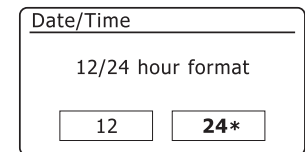
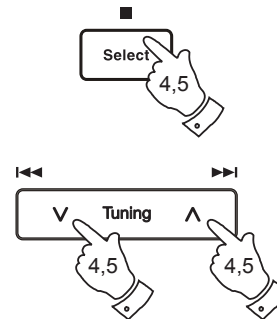
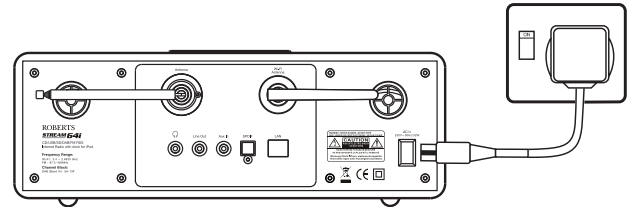

Connecting to your computer network - cont.

6. Press the **Menu Up** or **Down** buttons to choose an auto-update option for the clock. This can be updated from DAB or FM radio, from the Network, or not updated. The default is to auto update from the network. If you choose any other option, go to step 9. Otherwise you will first need to select the correct time zone and daylight savings setting, see steps 7 and 8. If you choose 'No update' you will need to set the clock manually later, see page 85. Press the **Select** button to confirm your choice.

7. Press the **Menu Up** or **Down** buttons to highlight the time zone which is applicable to your location. Press the **Select** button to enter the setting.

8. You will then need to set the Daylight Savings option according to your location (Daylight Savings is also known as Summer/Winter time or BST/GMT adjustment).

Press the **Menu Up** or **Down** buttons to highlight 'YES' to turn on daylight savings if required or 'NO' if you do not wish to use daylight savings then press the **Select** button to confirm the setting.

In the UK, 'ON' is equivalent to British Summer Time and 'OFF' is equivalent to Greenwich Mean Time.

9. The display will then show a list of WiFi regional options for the network set up (for the UK choose 'Most of Europe'). Press the **Menu Up** or **Down** buttons to highlight the required region and then press the **Select** button to select it. Do this even if planning to use the wired Ethernet connection. Your radio will then scan for available WiFi networks. If using WiFi we recommend that the WiFi antenna is positioned vertically.

10. The radio will enter the Network Settings Wizard and will display 'Scanning...'. After a short while the display will show a list of the available WiFi networks. If you are intending to use the WiFi connection, go to step 11.

To use the Ethernet connection to your router (with automatic configuration), Press the **Menu Up** or **Down** buttons to point to the '[Wired]' menu item. Press the **Select** button and the radio will attempt to connect.

Configuration

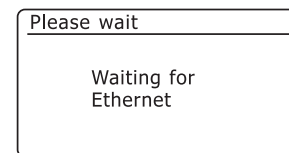
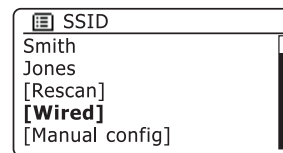
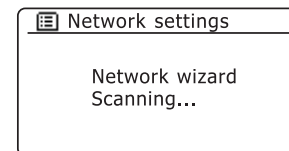
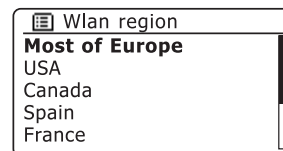
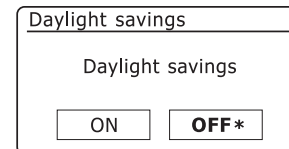
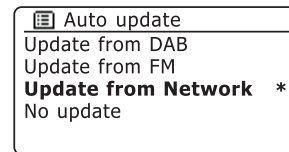
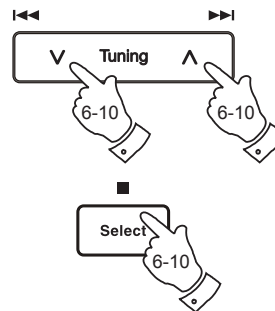

Connecting to your computer network - cont.

If your network allows automatic configuration (which is normal) the radio will acquire a network address. The screen should say 'Connecting...', and then 'Setup wizard completed'. Press the **Select** button to exit the setup wizard and show the main menu. You can then skip to paragraph 18 on page 17.

There are two indicator lights incorporated into the RJ-45 connector. If you have problems with your wired connection, they may help you to identify the possible cause of the problem.

Yellow ON = Link established; OFF = no connection

Yellow Flashing = Data transfer

Green ON = 100 Mbits/sec link; OFF = 10 Mbits/sec link

If your network does not support automatic configuration or if you wish to set it up manually then you should select '[Manual config]' instead of selecting '[Wired]' in the Network Wizard, then see page 19.

11. If you plan to use a WiFi connection, you will first need to identify your network in the list of network names presented by the Network Wizard. If no networks are found then you may have to get your wireless router working (please see the instructions supplied with it) or you may be too far from the router.

When the radio finds your wireless network, it displays the Network Name (SSID) for the wireless access point on the screen. This is a name that is allocated to the access point in your router by the person who set up the network - for example: '*Jones family*' or '*Paul's network*'. If the router supports WiFi Protected Setup, then '[WPS]' will be shown in front of the SSID.

It is possible, and in some locations highly likely, that your radio will find more than one wireless network, in which case you should choose which one you need to connect to.

12. Press the **Menu Up** or **Down** buttons to see the SSID for each wireless network that has been found. If your network is shown proceed to step 14 on the next page. If it is *not* shown then proceed to step 13.

If you make a mistake at any point, use the **Back** button to go back to the previous screen.

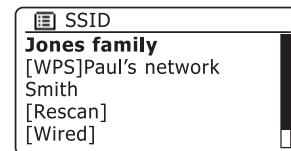
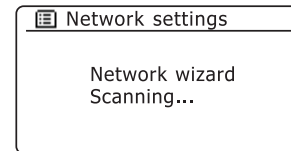
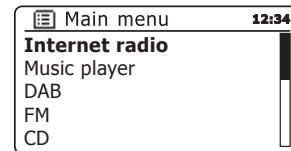
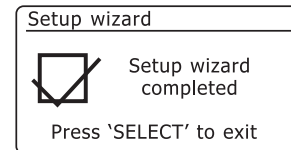
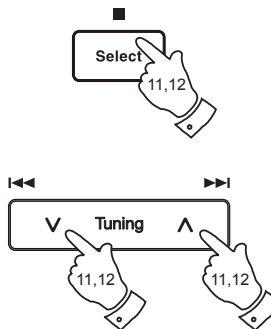

Connecting to your computer network - cont.

13. If your network is not found, it may be because the router is configured not to broadcast the SSID. You should then use the **Menu Up** or **Down** and **Select** buttons to highlight and select the '*Manual config*' option in order to enter the network details manually. This is described in 'Manual Network Configuration', see page 19.

If your network name is being broadcast, and it was not found, then try re-scanning (press the **Back** button), and if necessary try moving your radio to a location closer to your access point / router.

14. When the SSID for the wireless network you wish to connect to is highlighted on the screen, press the **Select** button. If WiFi Protected Setup (WPS) was indicated, you will see an additional menu at this point, otherwise proceed to step 15.

Choose one of the WPS menu options as required for your router (WPS may be via push button, or using an identification number).

'Push Button' - the display prompts you to press the WPS button on your router and then the **Select** button on the radio. The two devices should then connect with the encryption key sent automatically to the radio.

'PIN' - the display shows an identification number which you must enter into your router using a web browser (refer to your router's user documentation). You should then press the **Select** button on the radio. The two devices should then connect with the encryption key sent automatically to the radio.

'Skip WPS' - if you wish to enter the encryption key yourself (or if it was previously entered).

If you chose Push Button or PIN the screen will then show '*Connecting...*' and then '*Setup wizard completed*'. Press the **Select** button to exit setup wizard and then go to paragraph 18 on the next page.

15. If your network is configured without an encryption key, the screen should say '*Connecting...*', and then '*Setup wizard completed*'. Press the **Select** button to exit the setup wizard and show the main menu. If this is the case then you have successfully connected your radio to your network, so please go to paragraph 18 on the next page.

16. If the screen displays 'Key:', it is because the network is using one of the encryption systems: Wired Equivalent Privacy (WEP) or WiFi Protected Access (WPA). You will need to enter the correct WEP or WPA key into the radio to allow it to communicate with your wireless network. If you do not have the WEP or WPA key, then you should obtain it from the person who set up your network. Some wireless routers may come with an encryption key already set up by the supplier, in which case you should refer to the documentation provided with it. WPA is used here to also include WPA2.

Configuration

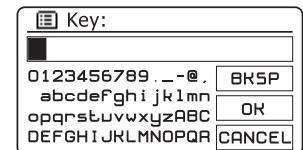
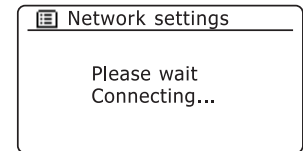
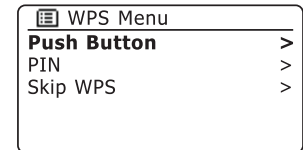
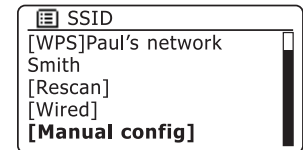
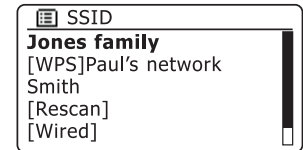

Connecting to your computer network - cont.

WEP keys are 10 or 26 characters long (using 0 - 9, and A - F). Some wireless routers can also use pass-phrases for WEP but these are not supported. WPA keys are usually set up using a pass-phrase of between 8 and 63 characters. Your radio accepts pass-phrases for WPA keys.

17. To enter the WEP or WPA key, characters are selected and entered using the **Menu Up or Down, Left or Right** (on the remote control) and **Select** buttons. The highlight scrolls through the available characters as well as the three controls on the right. The character currently highlighted will be entered when you press the **Select** button.

Do this as needed until the complete key has been entered. *Remember, WEP keys only use the numbers 0-9 and letters A-F. WPA keys are sensitive to upper and lower case characters. You must enter the key **exactly** or the radio will not connect to the network.*

The three controls on the right-hand side of the screen have special functions. You can quickly access these by pressing the **Info** button and then use the **Up** or **Down** and **Select** buttons as needed:

select '**ⓀⓂⓈⓅ**' to erase a character just entered (long press to clear)

select '**ⓄⓀ**' when the complete key has been entered

select '**ⓐⓃⓄⓁⓔ**' to cancel and re-run the Network Wizard

If a WEP or WPA key has previously been entered for the selected SSID then the display will show 'Key: [Set]'. If you have previously entered a different key, you must clear this by selecting the '**ⓀⓂⓈⓅ**' symbol. This will remove the '[Set]' indication.

After the final character of the WEP or WPA key has been entered, highlight the '**ⓄⓀ**' symbol and press the **Select** button. The screen will show 'Connecting...' and then 'Setup wizard completed'. Press the **Select** button to exit setup wizard. The radio should now be able to connect to the network.

18. Once you have connected your radio to the network (and therefore also to the Internet) it will display the main menu. Press the **On/Standby** button to put the radio in Standby mode. It should then display the time as obtained from the Internet. If the time display is not correct for any reason, it can easily be adjusted later, see page 85, 'Manually setting the clock'.

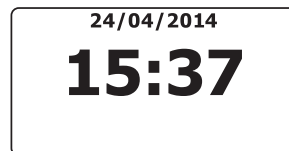
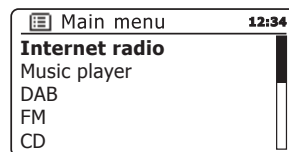
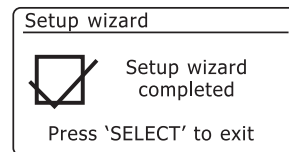
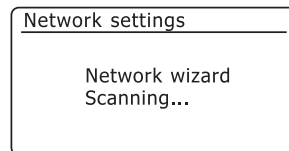
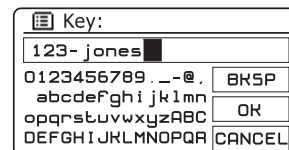
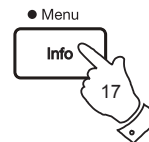
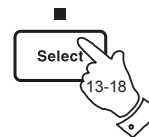
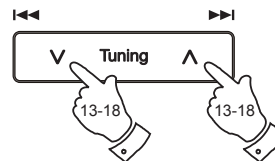

Connecting to your computer network - cont.

If you have followed the steps on the preceding pages successfully, your radio will have connected to your router, and then made a connection to the Internet and set its clock. If this is the case, then you can try listening to radio stations via the Internet as described on page 22 onwards.

Changing the network connection

In the sections above, you chose how your radio would be connected to your network, either using a WiFi connection or using a wired Ethernet cable. From time to time, you may find that you need to connect to different computer networks. The Internet setup menu allows you to change your radio's network settings, scan for an alternative wireless network, or to manually configure the network parameters.

The steps outlined below describe how you can do this - see also the section 'Network profiles' on page 102. If you have no need to do this, however, please skip to page 22.

Configuring the radio to use an alternative WiFi connection

1. From the Network settings menu select '*Network wizard*'. This will present you with details of any WiFi networks that are found. Scroll down the list using the **Menu Up** or **Down** buttons to the desired network name. Press the **Select** button to select this network.

The radio will then use its WiFi system to communicate with the network. Depending on the settings for the new network you may need to enter an encryption key (see pages 16-17). By default the radio will then acquire an IP address and other network settings from your router using DHCP.

Configuring the radio to use the wired Ethernet connection

2. Connect your radio to your router using an Ethernet cable plugged into the RJ-45 socket (marked LAN) at the back of the unit. From the Network settings menu select '*Network wizard*'. This will present you with details of any WiFi networks that are found. Scroll down the list to the '*[Wired]*' option using the **Menu Up** or **Down** buttons. Press the **Select** button to select this.

The radio will then use its Ethernet connection to communicate with the network. By default the unit will then acquire an IP address and other network settings from your router using DHCP.

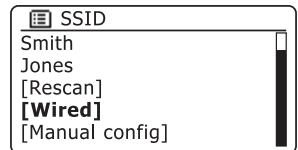
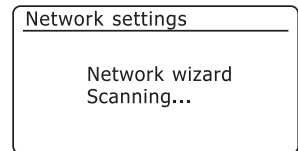
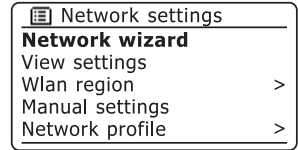
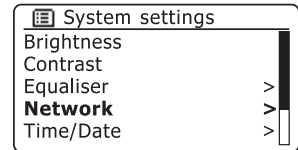
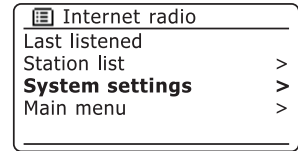

Manual network configuration

If you do not wish to use DHCP for automatic configuration, or if your network is configured with a hidden SSID, then you will need to enter some network settings manually. (Note - a hidden SSID may prevent casual observers from detecting your network, but it is not recommended as a means of network security.)

1. From the radios Network settings menu, select '*Manual settings*'. You must then choose whether to connect using '*Wired*' or '*Wireless*' connections. If you choose '*Wireless*' there are as many as nine settings screens, shown by the '*1 of 9*' progress marker in the top right corner of the display. If you choose '*Wired*' there are five screens and the progress marker will reflect this, although the steps to set up the network parameters are basically the same.
2. The next menu asks whether you wish to use DHCP to configure your network parameters (IP address, subnet mask, gateway address, etc.). Unless you are familiar with networking and related terminology, we recommend that you allow the use of DHCP. Choose '*DHCP enable*' unless you need to specify the network details manually.

If you have chosen '*Wired*' and then '*DHCP enable*', your radio should now establish a connection to the router using the Ethernet cable. Please skip to step 11 on page 21.

If you chose '*Wireless*' and '*DHCP enable*', please skip to step 6 on page 20 in order to set up the wireless connection details.

If you chose '*DHCP disable*' for either connection method, the next step is to set up the IP address.

3. The manually specified IP address should be chosen to be compatible with the settings in your router and must be a unique address on your network. If you are using DHCP for some devices and static (manually configured) IP addresses for others, the IP address used should fall outside the range that the router may allocate using DHCP. Typically, the first three groups of digits will be the same for all devices on your network. To enter the IP address, press the **Menu Up** or **Down** buttons to set the value for each group of digits and then press the **Select** button or the **Left** or **Right** buttons (on the remote control) to enter the value and to move on to the next group. When the IP address has been entered, the subnet mask should be entered. The subnet mask defines which parts of the IP address are common across your network. For most small networks the subnet mask will be 255.255.255.0 and this is entered in the same way.
4. The Gateway address is normally the IP address of the router through which the radio connects to the internet and is entered in the same way as the previous addresses.

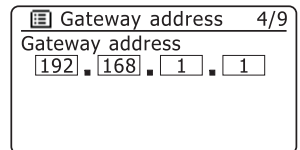
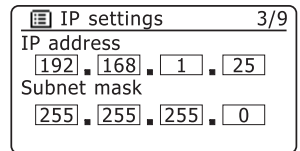
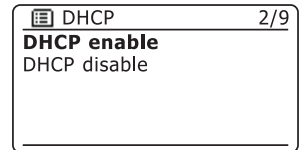
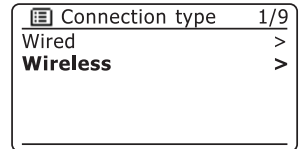
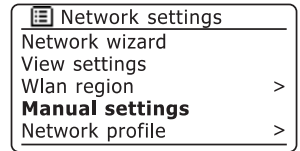

Manual network configuration - cont.

Configuration

5. In most installations the DNS settings (DNS = Domain Name Server) will be set to the same IP address as your router. In this case the secondary DNS may be left at zero.

To enter the DNS address, press the **Menu Up** or **Down** buttons to set the value for each group of digits and then press the **Select** button or the **Left** or **Right** buttons (on the remote control) to enter the value and to move on to the next group. Repeat this until all eight groups of digits have been entered.

If you previously specified *'Wired'* and then *'DHCP disable'*, your radio should now connect to the router using the Ethernet cable (in which case skip to step 11).

6. If you specified *'Wireless'*, the next step is to set up the WiFi connection, starting with the name of the wireless network (SSID) followed by the encryption options and password.

To enter the SSID, characters are selected and entered using the **Menu Up** or **Down**, **Left** or **Right** (on the remote control) and **Select** buttons. The radio scrolls through the available characters as well as the three controls on the right. The character currently highlighted will be entered when you press the **Select** button.

Do this as needed until the complete network name has been entered. *The SSID setting is sensitive to upper and lower case characters and symbols. You must enter it exactly as set up in your router.*

The three controls on the right-hand side of the screen have special functions. You can quickly access these by pressing the **Info** button and then use the **Menu Up** or **Down** and **Select** buttons as needed:

select **BRSP** to erase a character just entered (long press to clear); **Info** again to continue

select **OK** when the complete SSID has been entered

select **CANCEL** to cancel and go back to the DNS settings screen

7. Having entered the SSID, you must enter details of the encryption system used on your wireless network. This should be the same as specified in your router settings. If your network does not use encryption, then select the *'Open'* option. Your radio should then connect to the network, so skip to step 11. If your network uses WEP (Wired Equivalent Privacy) select the *'Pre-Shared Key'* option then go to step 8. The remaining options are for WPA or WPA2 (WiFi Protected Access) - see step 9.

8. If you chose *'Pre-Shared Key'* in step 7, you should then choose the WEP option. The key should be entered using only the numbers 0-9 and the letters A-F. The key will be 10 characters long for 64-bit encryption and 26 characters long for 128-bit encryption. The radio will accept lower-case letters *a-f* as equivalent to upper-case *A-F*. Spaces or special symbols are not permitted in WEP keys.

 DNS	5/9
Primary DNS	
[192] [168] [1] [1]	
Secondary DNS	
[0] [0] [0] [0]	

 SSID	6/9
mynetwork	
0123456789 . _ - @	BRSP
abcdefghijklmnop	OK
opqrstuvwxyzABC	
DEFGHIJKLMNOPQR	CANCEL

 Authentication	7/9
Open	
Pre-Shared Key	
WPA	
WPA2	

 Encryption type	8/9
Disabled	
WEP	

 Key:	9/9
01234ABCDE	
0123456789 . _ - @	BRSP
abcdefghijklmnop	OK
opqrstuvwxyzABC	
DEFGHIJKLMNOPQR	CANCEL

Manual network configuration - cont.

The three controls on the right-hand side of the screen have special functions. You can quickly access these by pressing the **Info** button and then use the **Menu Up** or **Down** and **Select** buttons as needed:

- select '**BRSP**' to erase a character just entered (long press to clear); **Info** again to continue
- select '**OK**' when the complete encryption key has been entered
- select '**CANCEL**' to cancel and go back to the SSID settings screen

Once the key is entered the radio should connect to your network. Please skip to step 11.

9. WPA and WPA2 are similar, although WPA2 offers a higher level of security. Whichever you selected in step 7, you then have to specify the variant used. They are TKIP (Temporal Key Integrity Protocol) and AES (Advanced Encryption Standard). As previously, the setting should match that used by your router. Some routers allow both to be specified, and the router will use whichever variant is supported by the connected device. AES is regarded as the more secure option if it is available.

10. The radio will then require you to enter the encryption key. This must be a string of between 8 and 63 characters and must be identical to the key which has been entered into your router. *Note - the encryption key is sensitive to the use of upper and lower case letters and symbols. Take care to enter the key exactly, or the radio will not be able to connect to your router.*

The three controls on the right-hand side of the screen have special functions. You can quickly access these by pressing the **Info** button and then use the **Menu Up** or **Down** and **Select** buttons as needed:

- select '**BRSP**' to erase a character just entered (long press to clear); **Info** again to continue
- select '**OK**' when the complete encryption key has been entered
- select '**CANCEL**' to cancel and go back to the TKIP / AES options screen

Once the key is entered the radio should connect to the network.

11. While the radio is trying to connect to the network, it will display '*Processing...*' when checking the encryption key (if using the WiFi connection) and then '*Connecting...*'. If the connection is made successfully, the radio will return to the Network settings menu. If the unit cannot connect, then it will display a '*Failed to connect*' message and will return to the SSID entry screen (step 6).

Once connected, the network settings are stored in the radio. The settings are retained when the radio is disconnected from the mains.

You may now use the **Back** and **Radio** or **Media** buttons to access the functions of your radio.

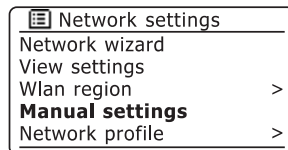
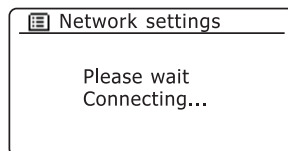
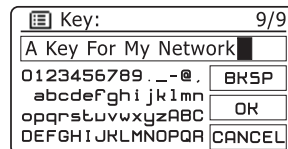
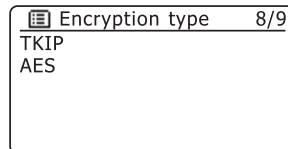
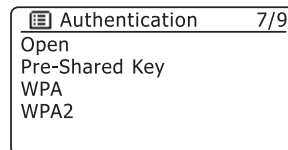

Internet Radio

Internet Radio - the basics

Before you can use your radio to listen to broadcasts via the Internet, it is necessary to have connected it to your computer network using either the wireless (WiFi) connection or the wired Ethernet connection (RJ-45 socket) located on the back of the unit. Please see page 13 for details.

There are literally many thousands of radio broadcasts available via the Internet as well as 'Podcasts'. Your radio provides several ways of searching for broadcasts in order to make finding and choosing them easier. Once you have found radio stations which you like, you may either store them as presets within the radio, or add them to a list of your favourite stations which your radio can access. The number of presets is limited (there are ten presets on the radio), but you can store as many favourites as you like.

You may search for an internet radio station by Location. If you know the name of the station and the country from which a station is broadcast this may be the easiest method to find a station. It is also a great way to experience radio from other parts of the world.

You may also search for an internet radio station by Genre. If you prefer a particular type of music, Blues for example, you may search for a radio station that broadcasts that type of music, and you can choose from a list of Blues radio stations regardless of location, or taking location into account.

If you know part of the name of an internet radio station, you can enter it into the radio and it will search for stations that match that name. This can be helpful if you are unsure of the location or genre of a particular station.

The Stream 64i radio connects to a radio station database which serves many users in many countries. This means that there is a very wide range of programme content available. You can also search for stations which have been recently added to those available (new stations) or you can search for the most popular.

Selecting a radio station by location

1. Press the **On/Standby** button to switch the radio on. Then press the **Radio** button to select the *Internet radio* mode display.
2. **Press and hold** the **Menu** button to enter the main *Internet radio* menu. Press the **Menu Up** or **Down** buttons until '*Station list*' is highlighted on the display and then press the **Select** button to select the option.
3. Press the **Menu Up** or **Down** buttons until '*Stations*' is highlighted on the display and then press the **Select** button.
Note that the menu may offer one or more local selections based upon the country in which the unit is being used, according to your internet IP address ('*United Kingdom*' and '*BBC*' stations, for example).
4. Press the **Menu Up** or **Down** buttons until '*Location*' is highlighted on the display and then press the **Select** button to select.
5. Press the **Menu Up** or **Down** buttons to scroll through the list of continents. When the desired continent is highlighted press the **Select** button to enter your selection.
6. The display will show a list of countries within the chosen continent. If there are many countries shown you can scroll through the list continually in either direction. For example, if the chosen continent was Europe, then to find the United Kingdom scroll up from the top of the list to the bottom by pressing the **Menu Up** button. Press the **Select** button to choose the desired country.
7. You will typically find that you then have the option to select either '*All Stations*' or one of a number of categories. The lists are always sorted alphabetically, and long lists will wrap around from top to bottom or bottom to top.

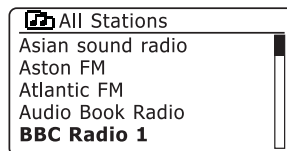
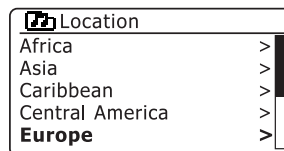
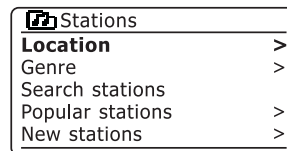
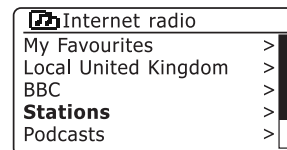
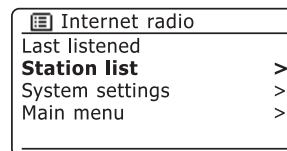
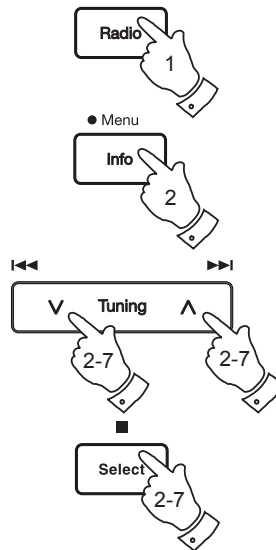

Selecting a radio station by location - cont.

8. Press the **Menu Up** or **Down** buttons to highlight your chosen radio station and then press the **Select** button to enter your selection. The display will show 'Connecting...' while the radio connects to the new station. The station should then start playing. Adjust the volume as needed.

9. If the station has on-demand content, that is, it gives the option of listening to programmes which have already been broadcast or to Podcasts, there will be an additional screen showing the radio station name as well as a 'Podcasts' option.

These are selected using additional menus, determined by the radio station and the content. There may simply be a list of programmes, or there may also be options to choose from broadcasts on particular dates or days of the week. The examples shown here are typical.

Podcasts and Listen Again content can also be accessed separately from the main Internet Radio menu, see page 28.

If your radio cannot connect to a radio station

Note: If your radio is unable to connect to an internet radio station it will generally either display 'Network Error' or 'Stopped'. This can be for many reasons, but typically will be due to one of the following:

The radio station may not be broadcasting at the present time.

The radio station may not be able to accommodate any more connections from internet listeners.

The broadcaster may limit listening to specific countries or regions

There may be network congestion (either locally or at a distance) which is affecting the reliability of the connection.

If your radio can connect, but the audio is not continuous and the radio keeps having to reconnect, this may be due to the radio station only having limited connection capacity.

Please also refer to the Troubleshooting section on page 104.

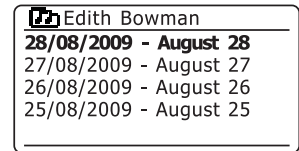
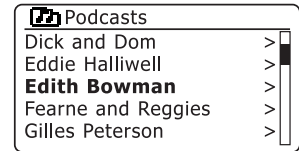
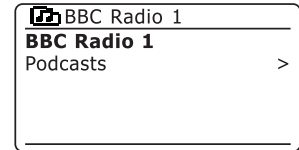
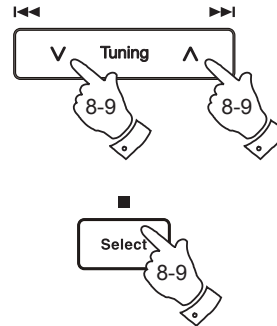

Selecting a radio station by genre

1. **Press and hold** the **Menu** button to enter the main *Internet radio* menu. Press the **Menu Up** or **Down** buttons until '*Station list*' is highlighted on the display and then press the **Select** button.
2. Press the **Menu Up** or **Down** buttons until '*Stations*' is highlighted on the display and then press the **Select** button.
3. Press the **Menu Up** or **Down** buttons until '*Genre*' is highlighted on the display and then press the **Select** button.
4. Press the **Menu Up** or **Down** buttons to scroll through the list of content types. This menu is normally cyclic - you can scroll the list continually in either direction. When the chosen genre is highlighted, press the **Select** button.
5. You then have the choice of '*All Stations*' of the chosen genre, or a list of countries. Note if a country is not shown then the station may still appear in the '*All Stations*' list. Press the **Menu Up** or **Down** buttons and the **Select** button to choose as needed
6. A list of radio stations is then shown. Press the **Menu Up** or **Down** buttons until the desired station name is highlighted on the display.
7. Press the **Select** button to select the station. The display will show '*Connecting...*' while it finds the new station. If the radio is unable to connect this may be for one of the reasons explained on page 24.
8. Adjust the **Volume** as needed to set the listening level.

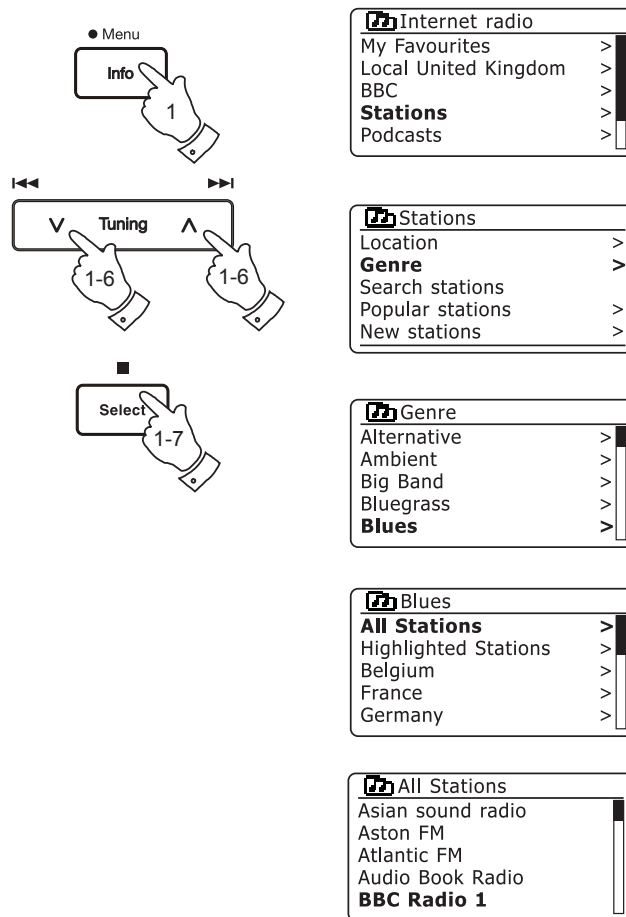

Searching for a radio station by name

There may be occasions when you know the name of a radio station but you do not know the location or genre. This facility allows you to search for the station using a part (or parts) of the radio station name.

1. **Press and hold the Menu** button to enter the main *Internet radio* menu. Press the **Menu Up** or **Down** buttons until 'Station list' is highlighted on the display and then press the **Select** button.
2. Press the **Menu Up** or **Down** buttons until 'Stations' is highlighted on the display and then press the **Select** button.
3. Press the **Menu Up** or **Down** buttons until 'Search stations' is highlighted on the display and then press the **Select** button.
4. To enter the search word(s) press the **Menu Up** or **Down, Left** or **Right** buttons (on the remote control) to highlight each character for the search in turn, and press the **Select** button to enter. If you make an error press the **Info** button to access the delete character 'BKSP' on the screen and then press the **Select** button. Press the **Info** button again to go back to the character selection. After the final character of the search has been entered, use the **Info** button and then the **Menu Up** or **Down** buttons to highlight the 'OK' symbol on the screen and then press the **Select** button to finish.
5. The radio will search for radio stations that match your search data. If you include a space between two search items the radio will look for station names which include both items. Thus a search for 'ROCK 100' could find a station called '100 Classic Rock Hits' as well as a station called '100.FM Rocks'
6. Press the **Menu Up** or **Down** buttons to highlight the station that you wish to listen to and press the **Select** button to confirm your choice. The display will show 'Connecting...' while it finds a new station.

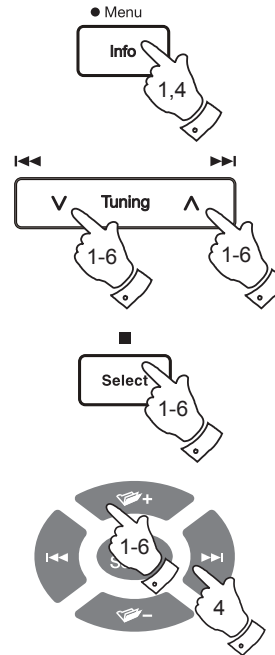

Internet Radio

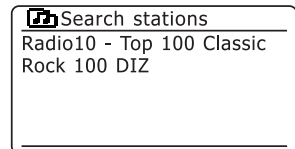
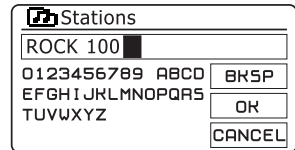
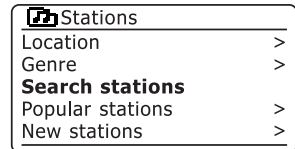
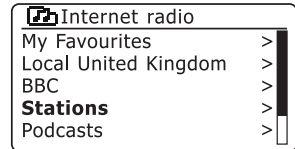
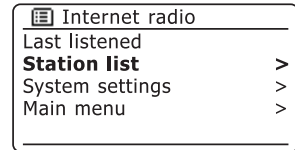

Selecting a new or popular station

As described in the section 'Internet Radio - the basics' on page 22, your radio connects via the Internet to a database of radio stations. This option is provided to highlight stations which are newly added to the list of those available, or stations which are particularly popular with listeners around the world. Your radio allows you to easily choose stations from these two categories, using menus very similar to those used when finding stations by location and genre.

1. **Press and hold** the **Menu** button to enter the main *Internet radio* menu. Press the **Menu Up** or **Down** buttons until '*Station list*' is highlighted on the display and then press the **Select** button.
2. Press the **Menu Up** or **Down** buttons until '*Stations*' is highlighted on the display and then press the **Select** button.
3. Press the **Menu Up** or **Down** buttons until '*Popular stations*' or '*New stations*' is highlighted on the display. Press the **Select** button to enter your choice.
4. Press the **Menu Up** or **Down** buttons to highlight the station that you wish to listen to and then press the **Select** button to enter your choice. The display will show '*Connecting...*' while the new station is found.

If the radio is unable to connect to a particular radio station this may be for one of the reasons explained on page 24.

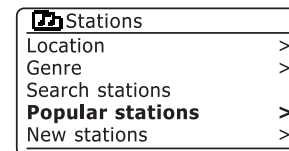
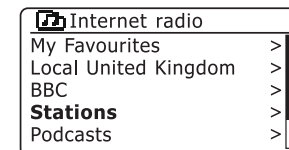
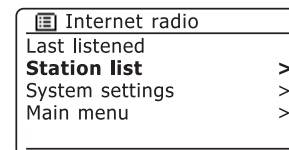
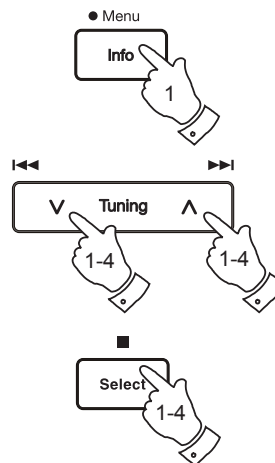

Selecting a podcast / BBC Listen Again

Some radio stations allow you to listen to programmes that have already been broadcast. The BBC's Listen Again service is an example of this. In addition, radio broadcasters and individuals may make programmes which are intended normally to be downloaded into a computer or copied onto a portable media player. These are commonly known as Podcasts.

On your radio, both Listen Again programmes and Podcasts are grouped together as Podcasts, and the same menu is used to access and listen to both types of programming. Listen Again programmes are also accessible via the *Stations* menu (see pages 23-24).

1. **Press and hold** the **Menu** button to enter the main *Internet radio* menu. Press the **Menu Up** or **Down** buttons until '*Station list*' is highlighted on the display and then press the **Select** button.
2. Press the **Menu Up** or **Down** buttons until '*Podcasts*' is highlighted on the display and then press the **Select** button.
3. You may then search by location, genre, or using part of the name of the podcast. The searches operate in exactly the same way as when searching for a conventional radio station.

Searching by location is done first by continent, then by country. You may then list '*All shows*' or search within a country by genre.

Searching by genre is more direct, since once the genre is chosen the next menu display shows a list of available podcasts.

Searching by name operates in the same way as when searching for a named radio station, selecting the '**OK**' symbol when you have entered the text. You may enter one or more pieces of text which will be used for the search.

4. Press the **Menu Up** or **Down** buttons and then press the **Select** button to confirm your chosen podcast. The display will show '*Connecting...*' while it finds the new programme.

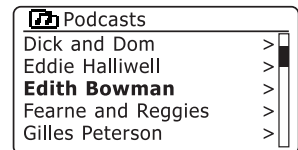
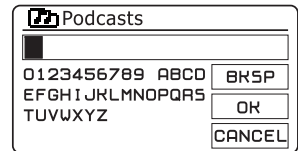
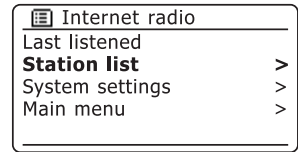
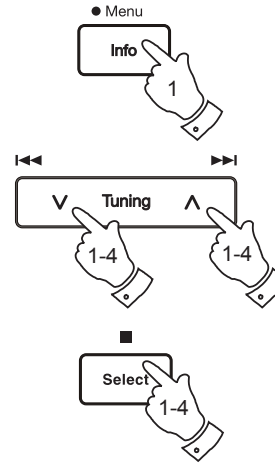

Presetting stations

With so many Internet radio stations available, it is desirable to have a means of rapidly selecting the stations that you listen to most frequently. Your radio has ten memory presets which can easily be set to store the details of any Internet radio station. The radio station presets are retained in memory even when the radio is switched off.

Please see also the sections 'Last Listened' on page 30 and 'Configuring My Favourite Stations' on page 33.

Storing a preset

1. Press the **On/Standby** button to switch on your radio. Tune to the required station using one of the methods described on the preceding pages.
2. To store the currently playing radio station as a preset, press and hold the required **Preset** button (1 - 10) on the remote control until the display shows 'Preset stored'. The station will be stored using the chosen preset button. Repeat this procedure as needed for the remaining presets.
3. Stations which are already stored in the presets may be over-written by following the above procedure.

Recalling a preset

1. Press the **On/Standby** button to switch on your radio. Select the **Internet radio** mode using the **Radio** button.
2. Momentarily press the required **Preset** button on the remote control. Your radio will then connect to the station stored in preset memory. The preset used will be shown at the bottom of the display screen.

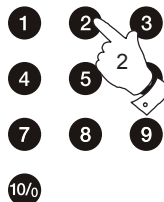
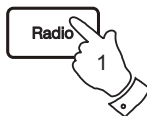
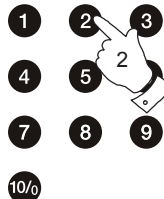

Last Listened

It is often helpful to be able to go back to a station that you have recently listened to. Your radio has a 'Last Listened' feature which provides you with quick access to the ten most recently listened to radio stations or podcasts. As each new radio station is listened to the oldest item is deleted from the list. The Last Listened list is stored when the radio is disconnected from the mains.

1. With the radio switched on and in *Internet radio* mode, **press and hold** the **Menu** button. The first item on the menu is '*Last listened*'. With this item highlighted press the **Select** button.
2. The display will then show a list of the last ten Internet radio stations or podcasts. Press the **Menu Up** or **Menu Down** buttons to highlight whichever you wish to listen to and then press the **Select** button to cause your radio to reconnect to that radio station or podcast.

Display modes

Your radio has a range of display options when in Internet Radio mode. Note that not all information may be available for all Internet radio stations

1. Press and release the **Info** button to cycle through the different options.
 - a. **Description** Displays information about the radio station or scrolling text messages such as artist/track name, phone number etc.
 - b. **Genre** Displays programme type information e.g. Pop, Classic, News, etc. and the location of the current radio station

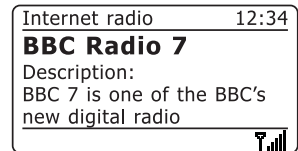
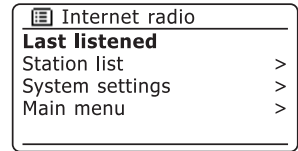
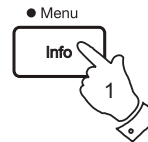
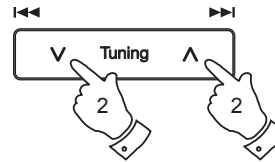
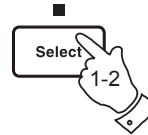
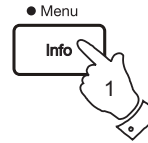

Display modes - cont.

- c. Reliability Displays the reliability of the data stream from the station currently being received.

- d. Format Displays the bit rate and format of the station being received.

- e. Playback buffer Displays status when connecting to and playing a radio station. This indicates the reliability of the data stream to your radio. If there are no bars shown to the right of the dividing line then the data stream reliability may be poor and you may find that there are many breaks in the audio (this is not always the case for REAL audio streams).

- f. Date Displays the current date.

Additional or alternative information may be displayed when listening to Podcasts. Categories displayable can include...

Episode name	Show description
Show genre	Show language
Episode URL	Bit rate
Codec	Sampling rate

Whenever the radio is displaying an information screen (as opposed to a menu screen), the time is displayed in the top-right corner of the display, and a WiFi strength or Ethernet connection indicator is shown in the bottom-right corner.

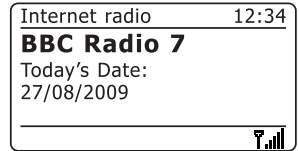
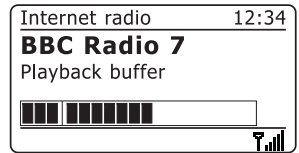
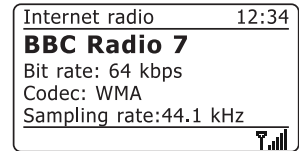
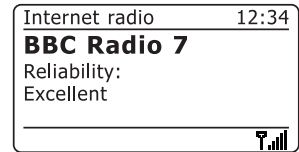

Customising your radio

In addition to storing your favourite radio stations in the radio presets, your radio allows you to create customised lists of stations which can appear in two special menus on the radio called 'My Favourites' and 'My Added Stations'.

Your radio uses a database which is accessed via the Internet in order to find out which radio stations are available and how it should connect to them. You are able to add your personal selections to this database. These will only be accessible by you using your PC or your radio. You can choose the stations which will appear in the 'My Favourites' menu from the large selection already listed. Additionally, if you find a radio station that is not listed then you may also add the Internet address (URL) of the station's audio stream to your selection. It will then appear on your radio via the 'My Added Stations' menu item.

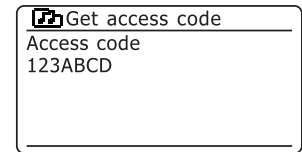
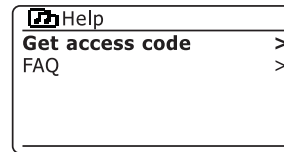
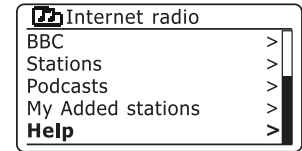
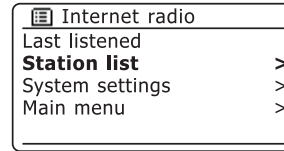

Registering an account

1. Open the web site <http://www.wifiradio-frontier.com> using the Internet browser on your computer. Click on the 'Register here' link and follow the on-screen instructions to register an account. During the registration process the web site asks for an access code. This allows it to uniquely identify your internet radio from the many others that it also provides data for. To obtain the access code, please follow these steps.
2. With your radio switched on and in Internet radio mode, **press and hold** the **Menu** button, then select 'Station list' using the **Menu Up** or **Down** and **Select** buttons.
3. Scroll down the Station list menu to the item called 'Help'. Press the **Select** button to enter the Help menu.
4. In the Help menu, select the menu item 'Get access code'. Provided that the radio is connected to the Internet, a code will be displayed of typically seven characters (upper case letters and numbers). Make a note of this code for the next step. If you need to re-register later you must repeat this process to get a fresh access code.
5. You should then use the code displayed by the radio to fill in the Access Code field on the web page when you set up your account.

Once you have your account set up, if you have other radios which use the same database, you may also add them to your account. You will need to get an access code from each radio in order to add it to the account. They may then share your favourite and added radio station details.

Customising your radio - cont.

Configuring My Favourite Stations

1. Using the web site at <http://www.wifiradio-frontier.com> it is possible to search among the many radio stations that are available by location, genre, or language. You may also choose from new or popular stations.
2. When the radio stations that you have found are shown on your computer screen, they are shown with a 'Play' icon and an 'Add to favourites' icon (the plus symbol and heart). Clicking on the 'Play' icon will allow you to hear the radio station via your computer. Clicking on the 'Add to favourites' icon will cause the radio station to be added to the list accessible via your radio.
3. To help you organise your favourites, and since you may have a great many after a while, the web site will allow you to specify the name for a category or group under which the radio station will be listed on your radio. Suitable names might be 'Rock', 'Smooth', 'Mum's stations', and so on. When ever you add another radio station to your favourites you can either add it to an existing category or create a new one.
4. Once you have Internet radio stations available in your My Favourite Stations list, you may play these stations from your radio. These stations will be available on your radio from the Internet radio menu item '*My Favourites*'.
5. To look at, modify or delete your favourite stations lists on the web site, use the link '*My favourites*' in the '*My account*' area. To delete a favourite radio station, click on the icon with a heart and minus symbol.

Configuring My Added Stations

1. If you wish to listen to a radio station which is not currently held in the database at <http://www.wifiradio-frontier.com> it is possible to add the details yourself. You will need to obtain the internet address (URL) for the audio stream for the station that you wish to add. This may be information provided by the radio station itself, via its web site, or perhaps passed to you from another listener.
Note: The URL for the audio stream will generally *not* be the URL for the web page from which you listen to the station on your PC.
2. Use the '*My added stations*' link in the '*My account*' area on the web site. This allows you to add details of new stations or to modify those already added. You can provide a name for the radio station which will be shown on your radio. You must also provide the web address, location and format details.
3. Once you have Internet radio stations available in your My Added Stations list, you may play these stations from your radio. These stations will be available on your radio from the Internet radio menu item '*My Added Stations*'.
4. It is possible to add the web addresses for audio streams which may not be playable by your radio. If you attempt to play such a stream, your radio will normally display an error message of some kind. The Roberts Stream 64i can only play MP3, WMA, AAC and Real Audio internet radio streams.
5. To look at, modify or delete your added stations list on the web site, use the link '*My added stations*' in the '*My account*' area. To delete an added radio station, click on the icon with a heart and minus symbol.

Selecting your favourite stations

1. **Press and hold** the **Menu** button to enter the main *Internet radio* menu.
2. Press the **Menu Up** or **Down** buttons until '*Station list*' is highlighted on the display. Press the **Select** button to enter the menu.
3. Press the **Menu Up** or **Down** buttons until '*My Favourites*' is highlighted on the display. Press the **Select** button and your favourite stations list will appear on the display (set up as described on the preceding page).
4. Press the **Menu Up** or **Down** buttons to highlight the required station and then press the **Select** button to confirm your selection.
The display will show '*Connecting...*' while it finds the new station.

If the station has on-demand content (that is, it gives the option of listening to programmes which have already been broadcast), please see page 28, 'Selecting a podcast / BBC Listen again'.

Should you be unable to connect to a particular station, please note that some radio stations do not broadcast 24 hours per day, and some stations are not always on-line.

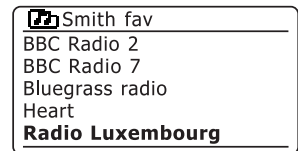
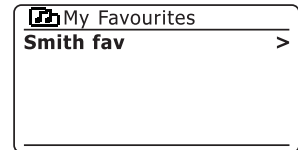
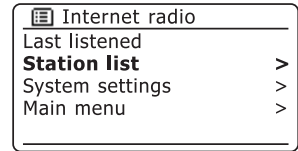
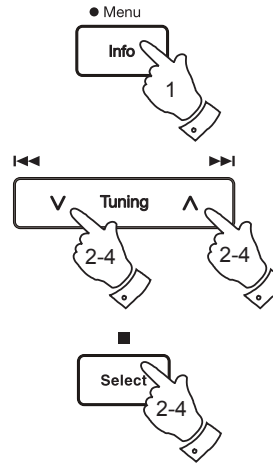

Selecting your added stations

1. **Press and hold** the **Menu** button to enter the main *Internet radio* menu. Press the **Menu Up** or **Down** buttons until '*Station list*' is highlighted on the display and then press the **Select** button.
2. Press the **Menu Up** or **Down** buttons until '*My Added Stations*' is highlighted on the display and then press the **Select** button.
3. Press the **Menu Up** or **Down** buttons to highlight the required station and then press the **Select** button to confirm your selection.
The display will show '*Connecting...*' while it finds the new station.

Should you be unable to connect to a particular station, please note that some radio stations do not broadcast 24 hours per day, and some stations are not always on-line.

In addition, as mentioned on page 33, it is possible to specify audio streams for '*My added stations*' which are not compatible with your radio. In this event the station will not be playable. The Roberts Stream 64i can only play MP3, WMA, AAC and Real Audio internet radio streams.

Note that the audio coding formats listed are generic terms. There are many variations of each format, as well a variety of streaming protocols in use by different radio broadcasters. Your radio has been designed to play the vast majority of coding and streaming formats in current use by broadcasters.

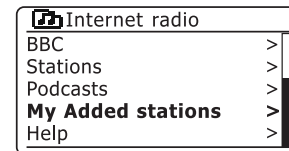
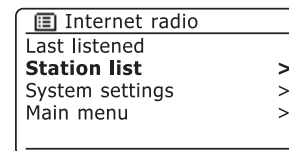
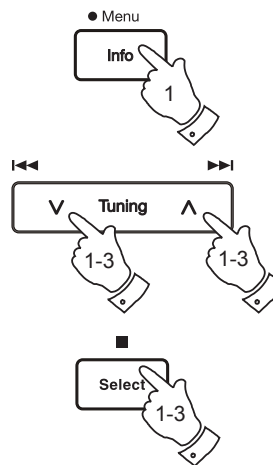

Use with Windows, Apple Mac and Linux

The Music Player allows you to play audio files which are stored on a computer on your network.

In order to play files from a computer on your network, your radio must connect to a file server application which uses the Universal Plug and Play (UPnP) protocol. If your computer uses Windows 7, Vista or XP, then it is likely that your computer already has a UPnP server application available. Windows Media Player (versions 11 and 12) has this capability, and it is able to make your files available to your radio. It also allows you to select files by Album, Artist, and so on.

Windows Media Player 12 can serve MP3, WMA, AAC and WAV files to your radio. Windows Media Player 11 is only able to serve MP3 and WMA files to your radio. If you have your audio files stored in the FLAC format, or if you are an Apple Mac or Linux user, there are other UPnP server applications which you may use with your radio.

The Music Player on the radio can playback audio files in MP3, WMA, AAC, FLAC and WAV formats. WMA Lossless files can also be played when using Windows Media Player as it will convert these to a compatible format before streaming them to the radio. Note that the playback of files encoded using WMA Voice, WMA 10 Professional, and for files which have DRM protection is not supported.

When using a UPnP server, the search and selection criteria are determined by the server software, but typically include Artist, Album and Genre. Many server applications also allow you to access your files according to the folders within which they are stored as well as other criteria.

Windows Media Player is less flexible than some other UPnP servers, but is generally easier to set up. It is supplied as a standard component of Windows 7, Vista or XP.

Many UPnP server applications are also capable of sharing pictures and video files to other network connected devices. If this is the case (as it is with Windows Media Player 11 and 12) you may see the option of choosing between 'Music', 'Video' and 'Pictures' on the Music Player's menu. You should only select the 'Music' option. Content offered via the alternative options will not be playable on your radio.

Some third party server applications allow customisation of the search criteria and indexing methods. This can be useful if you have a very large collection of stored music files.

Here is a short selection of alternative UPnP server applications, although many others are available:

Twonky Media Server (Windows, Apple Mac, Linux)

TVersity (Windows) *

Elgato EyeConnect (for Apple Mac OS X) *

MediaTomb (Linux, MAC OS X) *

* = free of charge versions available at the time of writing

Please refer to the documentation for your chosen server application for full details of its configuration and usage.

Accessing your audio files via a UPnP server

If your computer is running Windows 7, then Windows Media Player version 12 includes a UPnP server which will make your files available to your radio. If you have Windows Vista or XP please see page 106. There are other UPnP server solutions available for non-Windows users and for Windows users who may wish to use an alternative (see the preceding page).

It is beyond the scope of this instruction book to cover all possible options for UPnP. We explain the use of Microsoft's Windows Media Player here since that will be the first choice for the majority of users.

Set up UPnP access with Windows Media Player 12

1. Windows Media Player 12 (referred to here as WMP 12) can create a library from all the media files available to it on your PC. To add new media files to the library, select '*Library*', then '*Music*', then '*All music*' or '*Artist*', '*Album*' etc. This will show you the current library contents. You may then simply drag and drop files from other locations into the library. Alternatively, with media files or folders on the screen, you may right-click on the file or folder and select '*Include in library*' and then select '*Music*'. In this way you can quickly add additional content to your music library.
2. In WMP 12, click on '*Stream*' (see picture at right) and then select '*Automatically allow devices to play my media*'. Then accept the '*Automatically allow all computer and media devices*' option. There are other options (see overleaf) but this is the simplest if you just wish to quickly enable media streaming to your radio.
3. Press the **On/Standby** button to switch the unit on. Then press the **Media** button as needed until the *Music Player* mode display is shown. The main '*Music Player*' menu will then be displayed.

Selecting Media Streaming in Windows Media Player 12

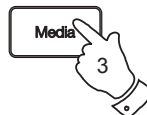
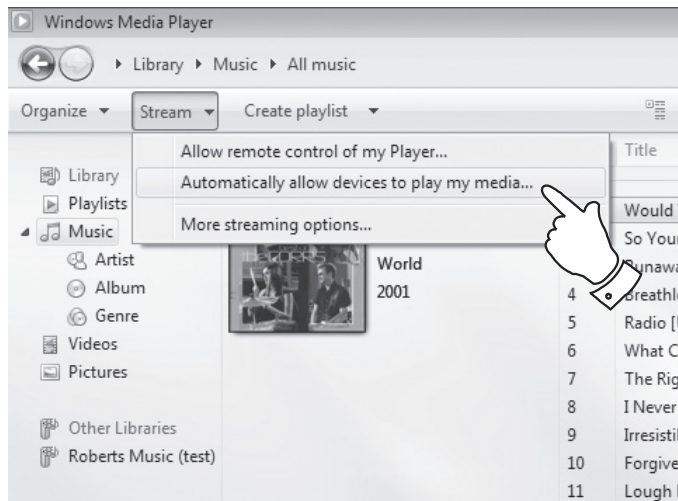

Set up UPnP access on a Windows PC - cont.

- Press the **Menu Up** or **Down** buttons until '*Shared media*' is highlighted and press the **Select** button to select. The radio will scan for all available UPnP servers. It may take a few seconds for the radio to complete its scan. The radio will display '<Empty>' if no UPnP servers are found.
- After scanning, select your UPnP server using the **Menu Up** or **Down** and **Select** buttons. If you allowed automatic connection previously, your radio should now connect and you may skip to the next page. If you did not permit automatic connections, your radio will then normally display '*Unauthorised*' at this stage.
- Your PC may prompt you that there has been a connection to your UPnP server. Whether prompted or not, in order that the radio may access the music files, you will need to click the '*Library*' tab in WMP 12 and select the '*Stream...*' item to open the '*Media Streaming*' window. Select '*Automatically allow devices to play my media*' then select '*Automatically allow all computer and media devices*'.

Alternatively select '*More Streaming options*' to enable sharing on a '*per device*' basis.

- In the '*More streaming options*' window, the radio will be listed as a blocked device. Click on the button shown to select '*Allowed*'.

Note: If you are using Microsoft Windows' firewall software, this should be correctly configured by WMP 12. If you are using third party firewall software you may need to manually configure it to allow your unit and WMP 12 to communicate (see the '*Troubleshooting*' section on page 104).

- On the radio, select the **named server** again using the **Menu Up** or **Down** and **Select** buttons. If WMP 12 is now able to communicate with your radio you will be presented with some media selection options on the display.

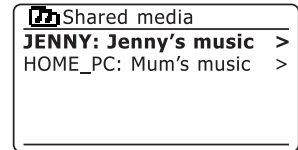
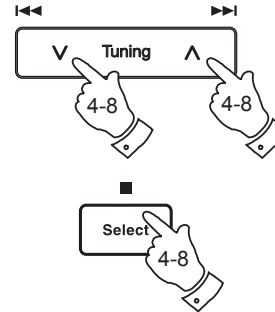

Allowing a device to connect to Windows Media Player 12

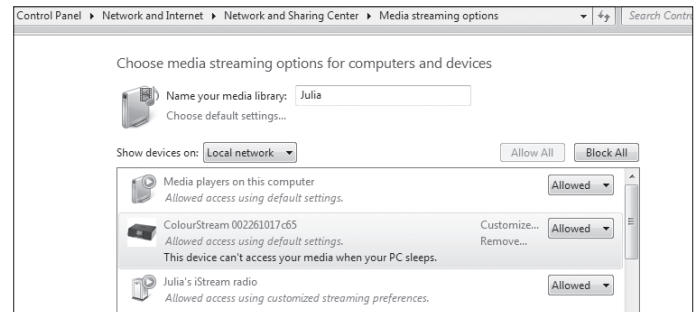

Locating and playing media files using UPnP

Once the UPnP server has been configured to share media files with your radio, you may select the files that you wish to play as follows:-

1. Press the **On/Standby** button to switch on the unit. Press the **Media** button as needed until the *Music Player* mode display is shown. The main Music Player menu will then be displayed.
2. Press the **Menu Up** or **Down** buttons until 'Shared media' is highlighted on the display and then press the **Select** button to cause the radio to scan for UPnP servers. Note that it may take a few seconds for the radio to complete its scan. The display will return to the Music Player menu if no UPnP servers are found.
3. After a successful scan, press the **Menu Up** or **Down** buttons to highlight your UPnP server and then press the **Select** button. If the display shows multiple media types, select 'Music'. (Some UPnP servers can serve pictures and video content to suitable devices.)
4. The radio will now list the media categories which are made available by the UPnP server - for example, 'Album', 'Artist' and 'Genre'. Press the **Menu Up** or **Down** buttons to highlight which category you wish to browse, then press the **Select** button to confirm your choice.

If you wish to use the search function press the **Menu Up** or **Down** buttons until 'Search' is selected on the display. You may select characters to build a keyword for searching for content to play.

When you first set up sharing with a UPnP server, not all of your files will be available immediately. The UPnP server must look inside each file to identify the artist and album information from 'tags' embedded in them. The server may also need time to access the Internet to obtain additional information such as 'album art' which it can display when you examine your music library on your PC. For a library of many files this can take some time.

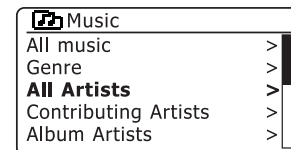
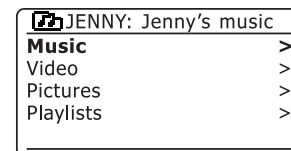
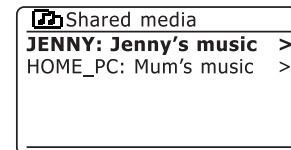
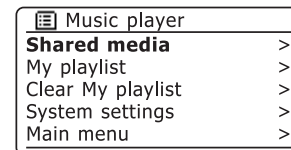
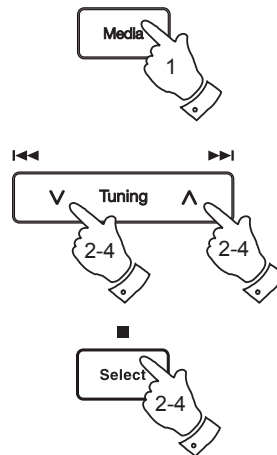

Media selection

When searching via UPnP you will have a selection of search criteria as determined by the UPnP server software on your computer. This allows you to search by a given information type (Album, Artist, Genre, etc.) and then to narrow the search to an album or to a particular track within an album.

Some UPnP server applications allow the search options to be customised. The searches described here are just examples of the possibilities.

Listening to a complete album

1. Use the **Menu Up or Down** buttons to choose content by Artist, Album, Genre, etc. according to your needs then press the **Select** button to enter your choice.
2. When you reach the album or folder the menu will then switch to showing the tracks in that album or folder. When searching by UPnP they will normally be listed in track number order (but as with the search criteria, this can vary according to the server application used).
3. With the first track in the album indicated, press the **Select** button. The album will then begin playing.

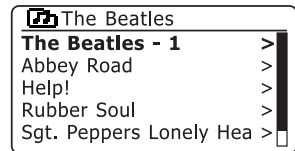
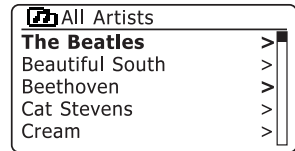
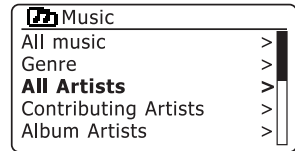
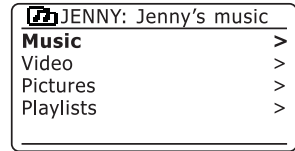
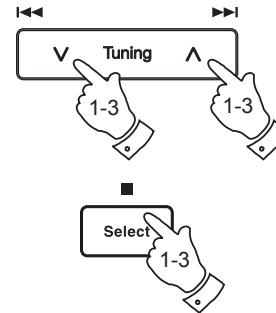

While the radio is playing from your media library, you may use the menus as described above to choose a different selection. When you select the track from which to play, the radio will then immediately begin playing the new selection.

Please see also 'Playlists' on page 44.

Listening to a particular track

1. If you wish to play only a particular track from an album or folder, first choose the album or folder as described on the preceding pages.
2. Press the **Menu Up** or **Down** buttons until the required track is highlighted.
3. Press and release the **Select** button. The track will begin playing. The radio will then play subsequent tracks from the same album or folder.

Controlling playback

1. Press the **Play/Pause** button to pause playback of the current track.
2. If you press the **Play/Pause** button, playback will resume from the point where it was paused.
3. Press the **Rewind** button to start playback of the previous track in the list.
4. Press the **Fast-forward** button to start playback of the next track in the list.
5. Press and hold the **Fast-forward** or **Rewind** button to move through the current track. The longer the button is pressed, the greater the speed at which the player will move through the track. Release the button when the desired point is reached. (Note that this feature is not supported when playing files encoded using the FLAC format.)

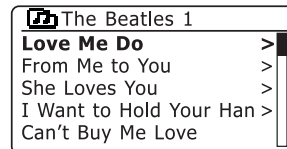
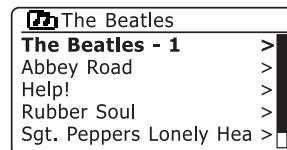
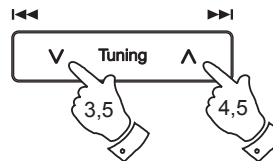
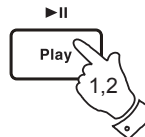
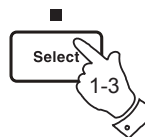
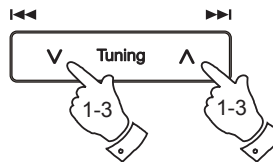

Controlling playback cont.

Repeat tracks

1. When playing a track activate the repeat option by pressing the **Repeat** button. Your selected tracks will be played repeatedly and the repeat indicator will show on the display.
2. To turn off the repeat option press the **Repeat** button again.

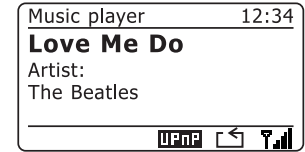
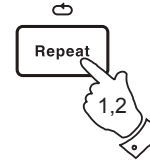

Shuffle tracks

1. When playing a track activate the shuffle option by pressing the **Random** button. Your selected tracks will be shuffled and the shuffle indicator will show on the display.
2. To turn off shuffle press the **Random** button again.

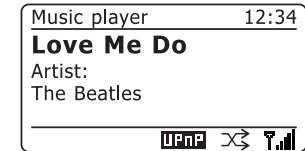

If both Repeat and Shuffle playback options are activated then both Repeat and Shuffle icons will be shown in the display.

Note: The shuffle play function may only be used if the current selection comprises fewer than 512 tracks.

Display modes

Your radio has a range of display options when in *Music Player* mode. Note that the availability of information depends on the specific media files, their format and upon the server capability. (Not all UPnP servers make information from the media files available in the same way.)

1. Press the **Info** button to cycle through the different options.
 - a. Progress bar Displays the playback progress for the track currently playing.
 - b. Artist Displays the artist information for the track currently playing.
 - c. Album Displays the album information for the track currently playing.
 - d. Format Displays the bit rate and format of the track currently playing.
 - e. Buffer Displays the radio's internal buffer status during media playback.

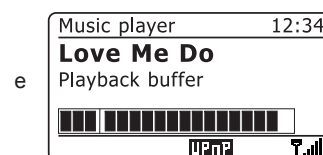
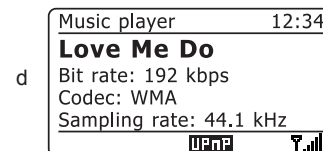
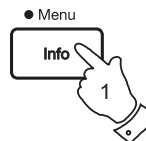

Playlists

Sometimes you may wish to set up a list of music tracks or albums which can then be played without further action - as background music for a party, for example.

Your radio can be configured to hold a queue of up to 500 tracks in a playlist menu. The tracks or albums for the playlist can be selected from your UPnP server. The playlist is held in memory in your radio until external power is removed, or until the playlist is cleared from the menu.

Adding a single track to your playlist

1. When selecting (or when playing) a track using a UPnP server **press and hold** the **Select** button and the display will show 'Added to My playlist'.
2. The track will be added to the playlist for playback later.

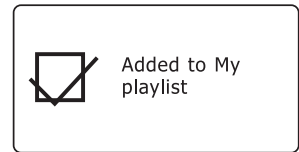
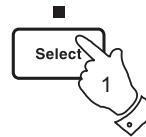

Adding an entire album or folder

3. When using a UPnP server highlight the chosen album, artist or folder and **press and hold** the **Select** button. The display will show 'Added to My playlist'.
4. Each of the tracks within the album, artist or folder selection will be added to the playlist individually. This allows any unwanted tracks to be removed from the playlist if needed (see next page).

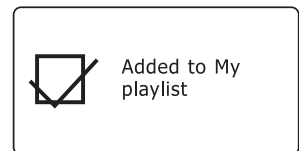
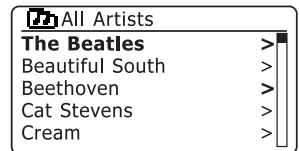
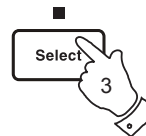

Viewing your playlist

1. Press the **On/Standby** button to switch on the unit. Press the **Media** button as needed until the *Music Player* mode display is shown. The *Music Player* menu will then be shown on the display.
2. Press the **Menu Up** or **Down** buttons until 'My Playlist' is highlighted on the display. Press the **Select** button to enter the playlist.
3. Press the **Menu Up** or **Down** buttons to scroll through the playlist. Tracks which are served via UPnP will show their track name.

Erasing a track from the playlist

1. **Press and hold** the **Menu** button to enter the main *Music Player* menu.
2. Press the **Menu Up** or **Down** buttons until 'My Playlist' is highlighted on the display. Press the **Select** button to enter the playlist.
3. Press the **Menu Up** or **Down** buttons until the track you wish to erase is highlighted. **Press and hold** the **Select** button.
4. You will be asked to confirm the deletion. To delete the track press the **Menu Up** or **Down** buttons until 'YES' is highlighted on the display. Press the **Select** button to cause the track to be deleted.
5. If you do not wish to delete the track highlight 'NO' and press the **Select** button to cancel the operation.

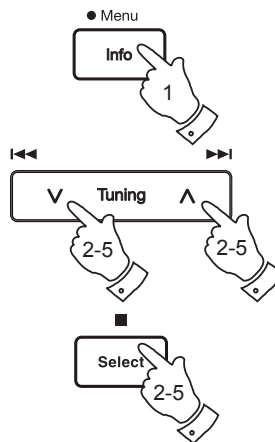
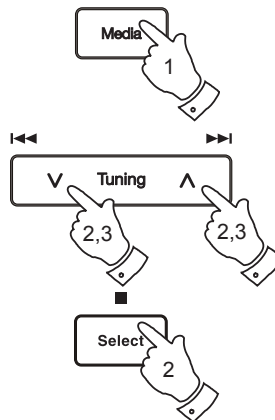

Clearing the playlist

1. **Press and hold** the **Menu** button to enter the main *Music Player* menu.
2. To clear the whole playlist press the **Menu Up** or **Down** buttons until '*Clear My playlist*' is highlighted on the display. Press the **Select** button.
3. To clear the whole playlist press the **Menu Up** or **Down** buttons until '*YES*' is highlighted on the display. Press the **Select** button to cause the playlist to be cleared.
4. If you do not wish to clear the playlist highlight '*NO*' and press the **Select** button to confirm.

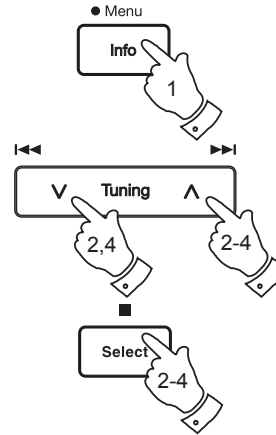

Playing your playlists

1. **Press and hold** the **Menu** button to enter the main *Music Player* menu.
2. Press the **Menu Up** or **Down** buttons until '*My playlist*' is highlighted on the display. Press the **Select** button.
3. To play the playlist from a particular track, press the **Menu Up** or **Down** buttons until the desired track is highlighted then press the **Select** button to start play.
4. While playing from the playlist, you can use this function to jump to a particular track within the playlist. While playing from the playlist, you may add additional tracks or albums or remove specific tracks (please see the preceding pages).

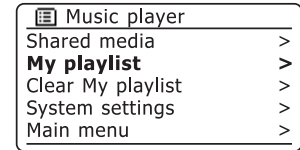
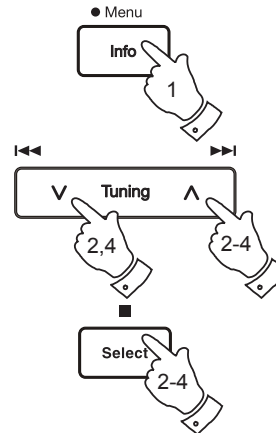

DAB Radio

Using DAB mode for the first time

1. Carefully extend the telescopic aerial.
2. Press the **On/Standby** button to switch on the radio. If the radio has been used before the last used mode will be selected.
3. Press the **Radio** button as needed so that *DAB radio* mode is selected on the display.
4. If this is the first time that DAB mode is used a quick scan of the Band III DAB channels will be carried out. The display will show 'Scanning'. (If the radio has been used before the last used station will be selected instead.)

During the scanning process, as new stations are detected the station counter will increase and the stations will be added to the list which is stored in the radio. The bar graph indicates the progress of the scan.

5. When scanning is completed the radio will list the stations found (in numeric-alpha order 0...9...A...Z), unless it has previously been tuned to a DAB station.

Press the **Menu Up** or **Down** buttons to scroll through the list of available DAB radio stations.

Press the **Select** button to select the highlighted station. The display may show 'Connecting...' while the radio re-tunes.

Use the **Volume** buttons to set the sound level as needed.

6. If the station list is still empty after the scan the display will show 'Service not available'. If no stations are found it may be necessary to relocate your radio to a position giving better reception.

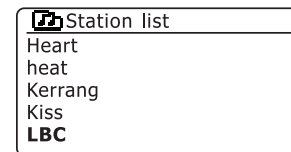
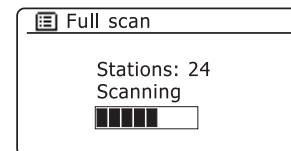
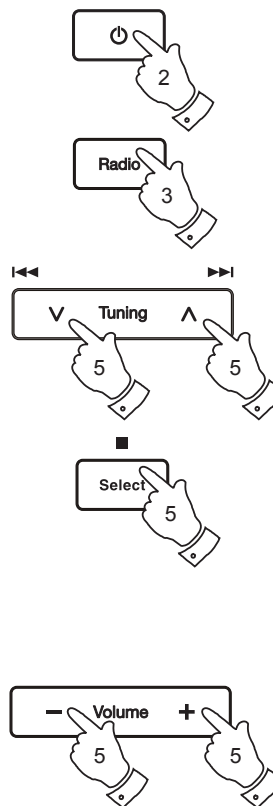

Selecting a DAB radio station

1. When playing a DAB radio station, the display normally shows the name of the current station with other related information.
2. Press the **Menu Up** or **Down** buttons to access the radio station list and to scroll through the available stations.
3. Press the **Select** button to select the highlighted station. The display may show 'Connecting...' while the radio re-tunes.
4. Use the **Volume** buttons to set the sound level as needed.

Note: If the display shows 'Station Not Available' it may be necessary to relocate your radio to a position giving better reception.

A question-mark in front of the station name merely indicates that the station has not recently been detected by the radio. It may still be available.

The use of the radio station presets is described on page 61.

Secondary services

Some DAB radio stations can have one or more secondary stations associated with them. Typically these are not broadcast continually. If a station has a secondary station available then the secondary will appear in the list of station names beneath the main (or primary) station. Examples are the programmes 'Daily Service' and 'Parliament' on BBC Radio 4.

1. To listen to a secondary service, press the **Menu Up** or **Down** buttons to scroll to the chosen station, and press the **Select** button to tune to the station.

If the secondary service is not available (off-air) then the primary service will be selected.

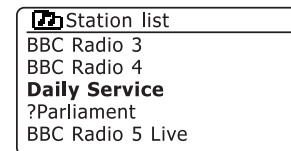
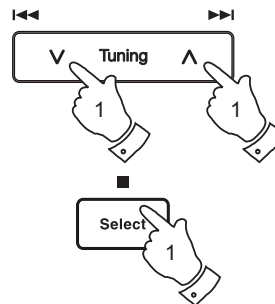
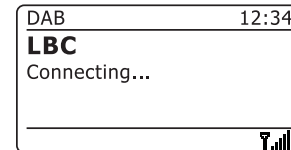
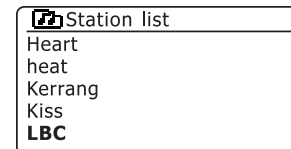
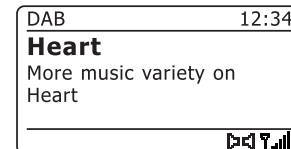
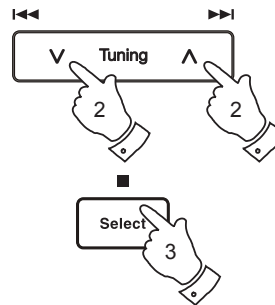

Display modes

Your radio has a range of display options when in DAB mode:-

1. Press the **Info** button to cycle through the different options.

- a. Text Displays text messages such as the artist or track name, phone in number, traffic alerts, etc.
- b. Program Type Displays the type of station being listened to such as Pop, Classic, News etc.
- c. Multiplex Name / Frequency Displays the name of the DAB multiplex to which the current station belongs as well as its broadcast frequency.
- d. Signal error / strength Displays the signal error and strength for the station being listened to. A lower error number indicates a better quality of radio signal. The signal strength graph can be used when positioning the radio or its antenna. For good reception the graph should occupy three or more blocks.

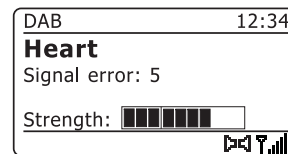
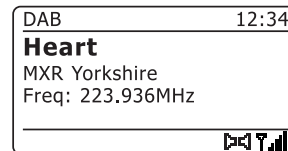
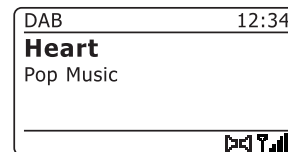
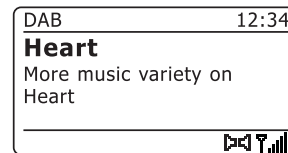
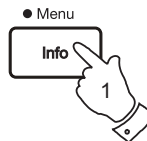

Display modes - cont.

- e. Bit rate and audio type Displays the digital bit rate and audio coding information for the station being listened to.

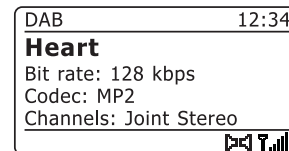

- f. Date Displays the current date.

A signal strength indicator is always shown in the lower area of the display on the right hand side.

If the broadcast being received is in stereo, then the stereo speaker symbol will be shown.

If the currently tuned station has been stored as a preset, then the preset number will also be shown (see page 61).

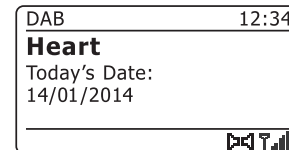

Finding new DAB radio stations

Should you wish to use your radio for DAB reception in a new location, or if no stations were detected during the initial scan, you can follow this procedure to allow your radio to find out which DAB radio stations are available.

1. Ensure that the telescopic antenna is extended, and then press the **Radio** button as needed to select *DAB radio* mode.
2. Once in DAB mode **press and hold** the **Menu** button.
3. Press the **Menu Up** or **Down** buttons until '*Full scan*' is highlighted on the display.
4. Press the **Select** button to initiate the scan. The display will show '*Scanning*' and your radio will perform a scan of the DAB Band III frequencies. As new stations are found the station counter will increase and stations will be added to the list. The bar graph indicates the progress of the scan.
5. Alternativley press the **Auto** button on the remote control to initiate a scan of the DAB Band III frequencies.
The Auto button may not operate in all display modes. In this case use the menu option above.

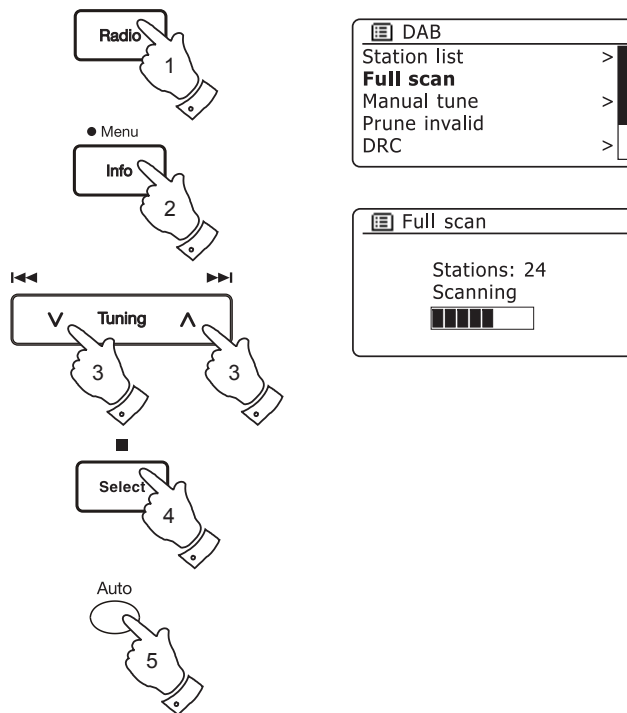

Manual Tuning

Manual tuning allows you to tune directly to the various Band III DAB channels (5A to 13F). At the time of writing, all UK DAB stations are located in the range of channels 11B to 12D.

1. When in DAB mode **press and hold** the **Menu** button so that the display shows the **DAB** menu.
2. Press the **Menu Up** or **Down** buttons until '**Manual tune**' is highlighted.
3. Press the **Select** button to enter manual tune mode.
4. Press the **Menu Up** or **Down** buttons to choose the required DAB channel.
5. Press the **Select** button to cause the radio to tune to the chosen channel.

When the radio has tuned, the display shows the channel number and frequency, and the name of the DAB multiplex found (if any).

A bar graph shows the signal strength and is useful if you need to reposition the radio or its aerial. The minimum signal marker 'I' which separates the left and right parts of the signal graph shows the minimum signal level required for satisfactory reception.

Any new radio stations found on the tuned DAB multiplex will be added to the list stored in the radio.

6. **Press and hold** the **Menu** button or press the **Back** button to choose a different frequency.
7. Press the **Menu** or **Back** button a second time to access the main DAB menu then select '**Station list**' to return to normal tuning.

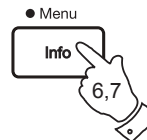
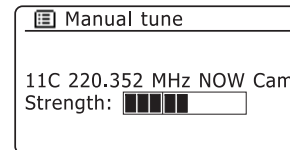
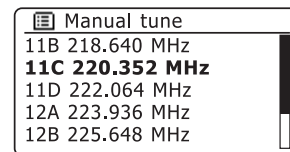
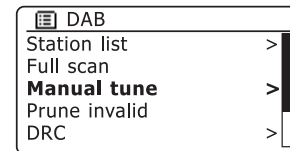
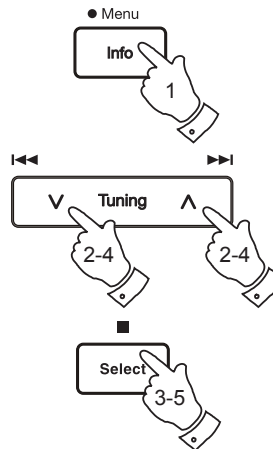

Dynamic Range Control settings

Dynamic Range Control (also known as DRC) can make quieter sounds easier to hear when your radio is used in a noisy environment by reducing the dynamic range of the audio signal.

1. Press the **On/Standby** button to switch on your radio.
2. Press the **Radio** button as needed to select *DAB radio* mode.
3. **Press and hold** the **Menu** button to enter the *DAB* menu.
4. Press the **Menu Up** or **Down** buttons until '*DRC*' is highlighted on the display.
5. Press the **Select** button to enter the DRC adjustment mode. The current DRC setting will be indicated with an asterisk.
6. Use the **Menu Up** or **Down** buttons to highlight the required DRC setting (the default is Off).
'*DRC Off*' - DRC is switched off, Broadcast DRC will be ignored.
'*DRC high*' - DRC is set as sent by broadcaster.
'*DRC low*' - DRC level is set to 1/2 that sent by broadcaster.
7. Press and release the **Select** button to confirm the setting.

Note: Not all DAB broadcasts use the DRC function. If the broadcast does not provide DRC information, then the DRC setting in the radio will have no effect.

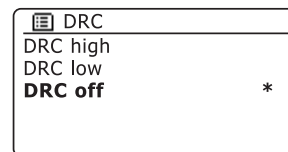
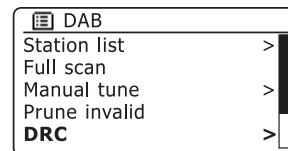
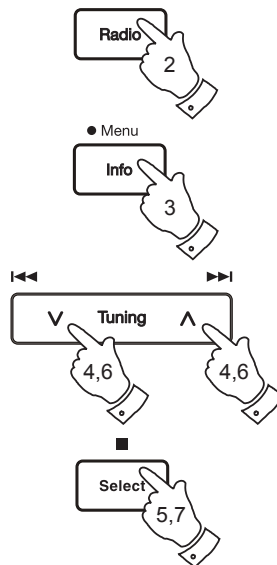

Station order setup

Your radio has 3 station order settings from which you can choose. The station order settings are, alphanumeric, ensemble and valid.

Note: The default station order on your radio is alphanumeric.

1. Press the **On/Standby** button to switch on your radio.
2. Press the **Radio** button as needed to select *DAB radio* mode.
3. **Press and hold** the **Menu** button to enter the DAB menu list.
4. Press the **Menu Up** or **Down** buttons until 'Station order' is highlighted. Press the **Select** button to enter the station order adjustment mode.
5. Use the **Menu Up** or **Down** buttons to choose between 'Alphanumeric', 'Ensemble' and 'Valid'.
 'Alphanumeric' - sorts the station list alpha-numerically 0...9 A...Z.
 'Ensemble' - organises the station list by DAB multiplex.
 'Valid' - shows only those stations for which a signal can be found.
 The current setting is indicated by an asterisk.
6. Press the **Select** button to select the required station order.
7. Press the **Back** button as needed to return to the DAB menu or to the stations list.

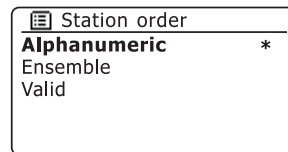
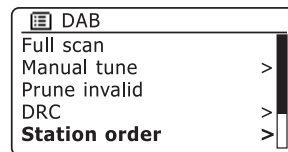
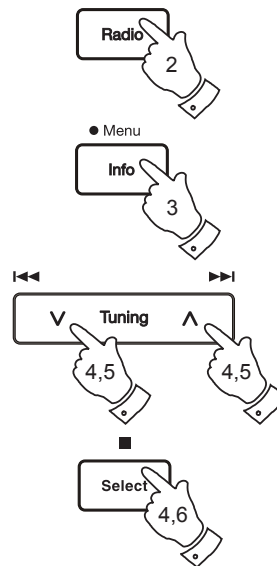

Prune stations

If you move to a different part of the country, some of the stations which were listed may no longer be available. Also, from time to time, some DAB services may stop broadcasting, or may change location or frequency. Stations which cannot be found, or which have not been received for a very long time are shown in the station list with a question mark.

The Prune stations function will delete the marked DAB stations from your station list.

1. Press the **On/Standby** button to switch on your radio.
2. Press the **Radio** button as needed to select *DAB radio* mode.
3. **Press and hold** the **Menu** button to enter the *DAB* menu.
4. Press the **Menu Up** or **Down** buttons until '*Prune invalid*' is highlighted. Press the **Select** button.
5. To cause the stations list to be pruned, eliminating unavailable stations press the **Menu Up** or **Down** buttons until '*YES*' is highlighted on the display.
6. Press the **Select** button to cause the invalid station names to be removed from the station list.

If you do not wish to prune stations, highlight '*NO*' and then press the select button. The display will revert to the previous menu.

Note: If you have moved your radio to a different part of the country you should also carry out a search for new stations (please see the section 'Finding new stations' on page 51).

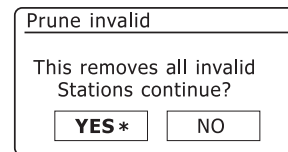
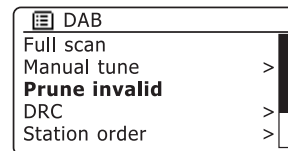
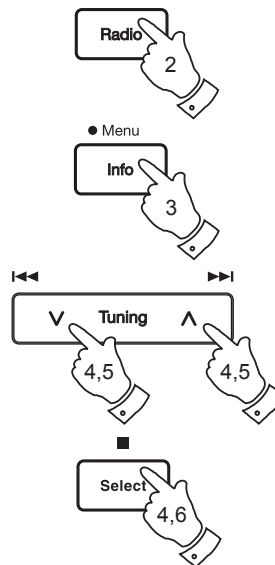

Operating your radio in FM mode

1. Carefully extend the telescopic aerial and press the **On/Standby** button to switch on your radio.
2. Press the **Radio** button as needed to select *FM radio* mode.
3. Press the **Menu Up** button (on the radio) or the **Right** button (on the remote control) and then the **Auto** button on the remote control. The displayed frequency will increase. Your radio will scan up the FM band from the currently displayed frequency and will stop scanning when it finds a station of sufficient strength.
4. The display will show the frequency of the signal which has been found. If RDS information is available, after a few seconds the display will show the radio station name.
If you only hear hiss or interference, simply press the **Auto** button to scan further. Your radio may have found a spurious interference signal.
5. To find more FM stations press the the **Auto** button (on the remote control) to repeat the scan operation. To scan down in frequency, press the **Menu Down** button (on the radio) or the **Left** button (on the remote control) and then the **Auto** button. Your radio will scan down the FM band from the currently displayed frequency and will stop scanning when it finds a signal of sufficient strength.
6. Alternatively press and hold the **Menu Up** on the radio to scan up in frequency or the **Menu Down** button to scan down the FM band. Alternatively press and hold the **Left** or **Right** buttons on the remote control.
7. When the end of the waveband is reached your radio will recommence tuning from the opposite end of the waveband. Use the **Volume** buttons to adjust the sound level as needed.

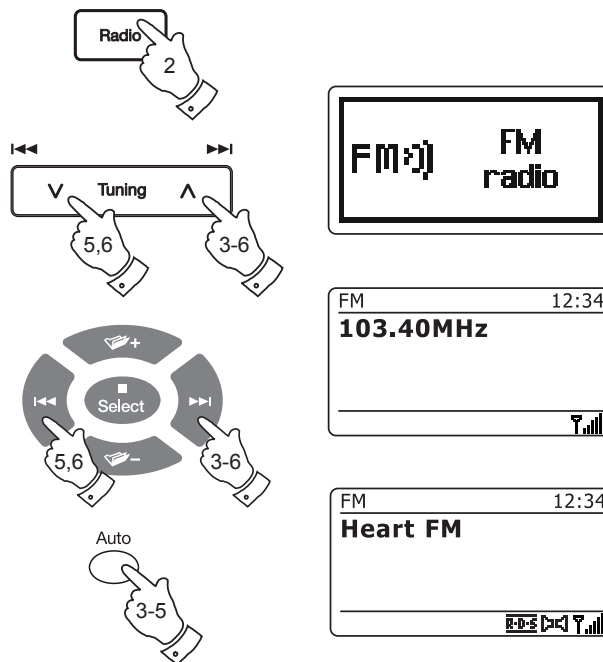

Manual tuning

1. Carefully extend the telescopic aerial and press the **On/Standby** button to switch on your radio.
2. Press the **Radio** button as needed to select *FM radio* mode.

3. Press the **Menu Up** or **Down** buttons (on the radio) or **Left** or **Right** buttons (on the remote control) to control the frequency that the radio will tune to. The frequency will change in steps of 50kHz.

When the end of the waveband is reached the radio will recommence tuning from the opposite end of the waveband.

4. Use the **Volume** buttons to adjust the sound level as needed.

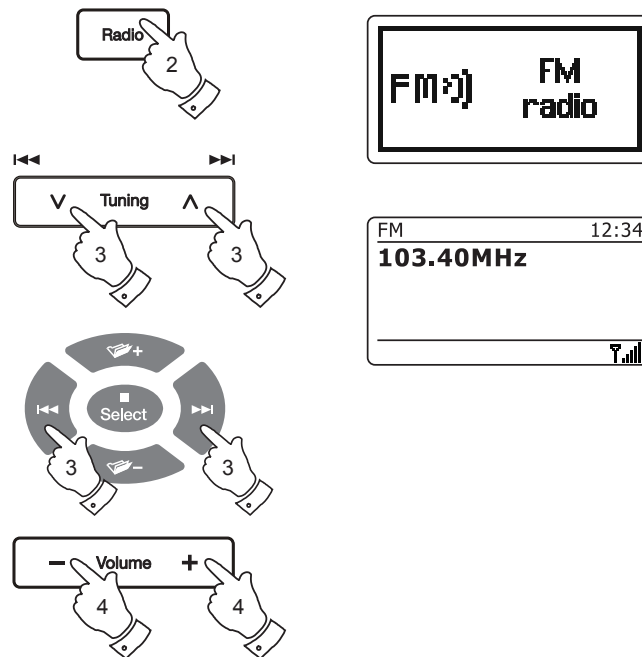

Display modes

Your radio has a range of display options when in FM mode:-

1. Press the **Info** button to cycle through the different options.
 - a. Text Displays text messages such as the artist or track name, phone in number, traffic alerts, etc.
 - b. Program Type Displays the type of station being listened to such as Pop, Classic, News etc.
 - c. Frequency Displays the frequency of the FM signal.
 - d. Date Displays the current date.

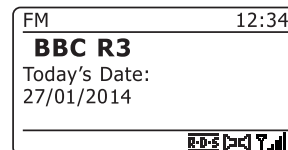
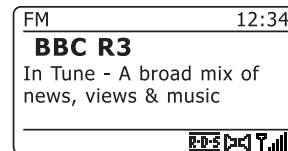
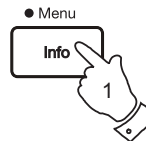

Note: If no RDS information is available, then the radio will only be able to display the frequency. There will be no text or programme type information available under these conditions.

The radio only provides displays when there is information available. So if there is no text, for example, that display is not available.

The RDS indicator at the bottom of the display shows that there is some RDS data present in the broadcast being received.

The stereo speaker display shows that the radio is receiving a stereo broadcast (please see also 'Stereo/Mono switching' on page 60).

Scan setting

When using the FM mode your radio can be set to either scan local stations or to scan all stations including distant radio stations.

1. Press the **Radio** button as needed to select *FM radio* mode.
2. **Press and hold** the **Menu** button to enter the *FM* menu.
3. Press the **Menu Up** or **Down** buttons until '*Scan setting*' is highlighted and then press the **Select** button to enter the scan adjustment mode.

The current scan setting is indicated with an asterisk.

4. To set your radio so that only the stations with the strongest signals are found during scanning press the **Menu Up** or **Down** buttons until '*YES*' is highlighted. Press the **Select** button to confirm the setting. (Normally this will restrict scanning to local transmissions.)

Alternatively, to set your radio so that all available stations are found during scanning (local and distant transmissions) press the **Menu Up** or **Down** buttons until '*NO*' is highlighted. Press the **Select** button to confirm the setting.

5. **Press and hold** the **Menu** button to return to the normal FM mode display.

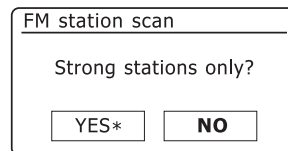
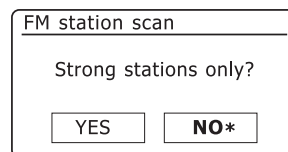
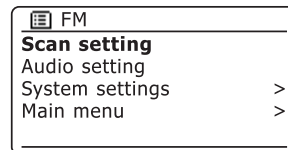
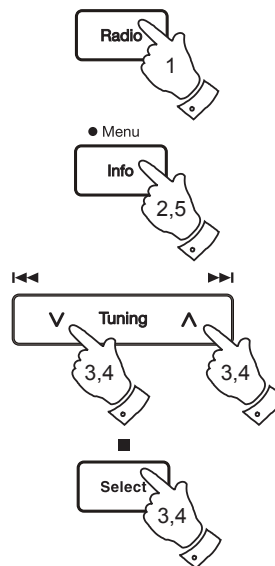

Stereo / Mono switching

If the FM radio station being listened to has a weak signal, some hiss may be audible. It is possible to reduce this hiss by forcing the radio to play the station in mono rather than stereo.

1. Press the **Radio** button as needed to select the *FM radio* mode display and tune to the required FM station as previously described.
2. **Press and hold** the **Menu** button to enter the *FM* menu.
3. Press the **Menu Up** or **Down** buttons until '*Audio setting*' is highlighted on the display. Press the **Select** button to enter the audio setting mode.
The current setting is indicated with an asterisk.

4. To switch to mono in order to reduce the hiss from a weak FM signal press the **Menu Up** or **Down** buttons until '*YES*' is highlighted. Press the **Select** button to confirm the setting.

Alternatively, to return to the normal automatic 'stereo or mono' mode press the **Menu Up** or **Down** buttons until '*NO*' is highlighted. Press the **Select** button to confirm the setting.

5. **Press and hold** the **Menu** button to return to the normal FM mode display.

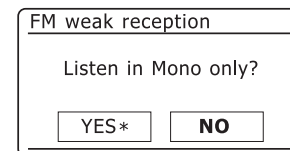
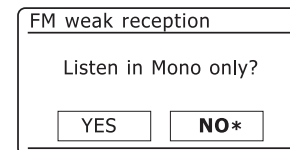
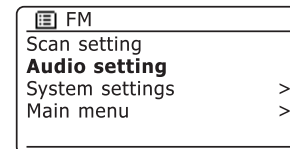
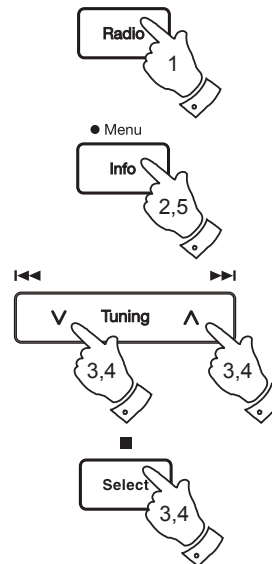

Presetting stations in DAB and FM modes

There are 10 memory presets each for DAB and FM radio. They are used in the same way for each operating mode.

1. Press the **On/Standby** button to switch on your radio.
2. Tune to the required radio station as previously described.
3. To store the station as a preset, **press and hold** the required **Preset** button (1 - 10) until the display shows 'Preset stored'. The station will be stored under the chosen preset button. Repeat this procedure as needed for the remaining presets.
4. Stations which are already stored in the presets may be over written by following the above procedure.

Note: The radio station presets are retained in memory when the radio is switched off and disconnected from the mains supply.

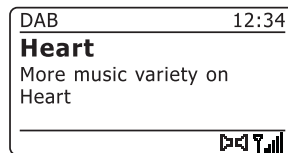
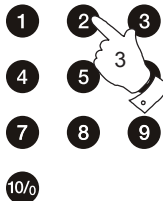

Recalling a preset in DAB and FM modes

1. Press the **On/Standby** button to switch on your radio.
2. Select the required operating mode using the **Radio** button.
3. Momentarily press the required **Preset** button. Your radio will then tune to the station stored in the selected preset memory. The chosen preset number is also shown in the lower area of the radio display, e.g. 'P2'.
4. Alternatively in FM radio mode only, use the **Menu Up** or **Down** buttons (on the remote control) to access FM presets already stored.

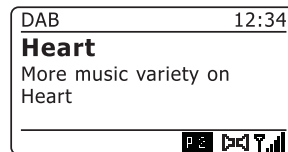
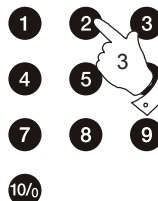
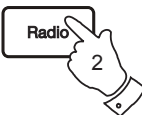

Compact discs

Use only Digital Audio CDs which have the  symbol.

DO NOT USE THESE TYPES OF DISC:

Mini (8cm) CDs. Use only full-size 12cm discs. Mini CDs will jam the feed mechanism.

Discs which do not have a complete metallic reflection layer. Discs with a large transparent section will not be detected and may fail to play or eject.

Discs which are extra thin or flexible. Such discs may fail to feed in or out correctly and may jam the CD mechanism.

Never write on a CD or attach any sticker to the CD. Always hold the CD at the edge and store it in its box after use with the label facing up.

To remove dust and dirt, breathe on the CD and wipe it with a soft, lint free cloth in a straight line from the centre towards the edge.

Cleaning agents may damage the CD.

Do not expose the CD to rain, moisture, sand or to excessive heat. (e.g. from heating equipment or in motor cars parked in the sun).

CD-R / CD-RW discs

Your Stream 64i can playback CD-DA format audio CD-R/CD-RW discs that have been finalised* upon completion of recording.

Your Stream 64i may fail to play some CD-R/CD-RW discs due to poor recording and wide variation in quality of the CD-R/CD-RW disc.

*Finalising enables a CD-R/CD-RW disc to playback on audio players such as your Stream 64i. A disc which has not been finalised may have information added to it using a computer but may not always be playable.

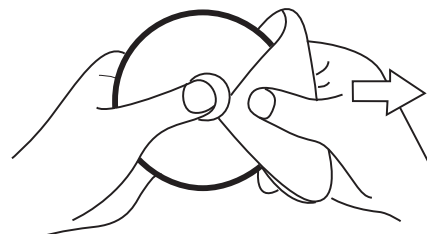

Inserting a CD

Ensure the CD player is empty before inserting a disc. If there is a disc in the player then the CD indicator will be lit. If you cannot insert a disc, press the **CD Eject** button to remove the CD currently in the player.

1. Press the **On/Standby** button to switch on your radio.
2. To select the CD mode press the **Media** button until 'CD' shows on the display.
3. To eject a CD press and release the **CD Eject** button. To reload a CD that has just been ejected, press the **Eject** button a second time.
4. Insert a disc with printed side facing up into the CD slot. The disc will be loaded automatically. The unit will check the CD type and load its track list. The display will show 'Loading' and then 'Reading' as the information is read.
5. If you load a disc containing MP3 or WMA files your radio will enter the MP3 / WMA mode (see page 68).

Playing a CD

1. Press the **Play / Pause** button to start playing the disc. The display will show the first track number.
2. Adjust the **Volume** to the required setting.
3. To pause playing press the **Play / Pause** button. To resume press the **Play / Pause** button again.

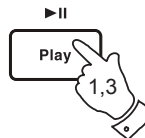
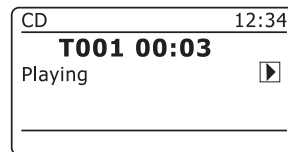
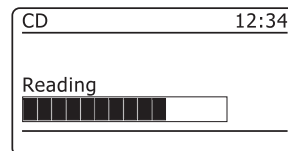
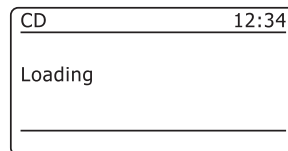
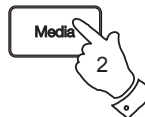

- To stop play, press the **Stop** button. The total number of CD tracks and the stop symbol (■) will be displayed.

If you put the unit into standby mode without pressing the Stop button, then the next time the unit is switched on it will return to the previously played track.

- To take out the CD, press the **CD Eject** button. The display will show 'Eject'. In order to protect the disc if it is not removed, the unit will reload the CD after 10 seconds and then enter standby mode.

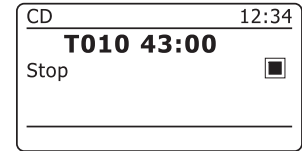

Selecting a track

- Whilst the CD is playing, press either the **Fast-forward** or **Rewind** buttons to change to the desired track. The updated track number is shown in the display.
- You can also skip tracks when the player is paused or stopped. Skip to the desired track using the **Fast-forward** or **Rewind** buttons, release the button when the desired track is displayed.
- Press the **Play / Pause** button to play the selected track.

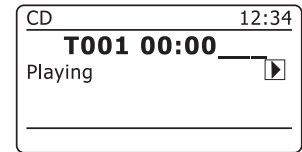
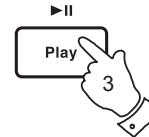
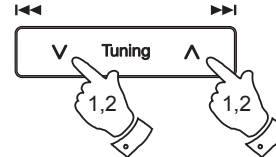

Select a desired track

- For track numbers 1-9 simply press the corresponding digit button. For track numbers ten and above press the required digits using the 10/0 button to enter the digit zero.
- If the track number entered exceeds the number of tracks on the CD, then the last track on the CD will be played.

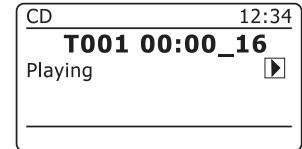
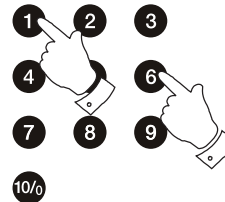

Search function

1. While the CD is playing, press and hold the **Fast-forward** or **Rewind** buttons. Release the button when the desired part of the track is reached.

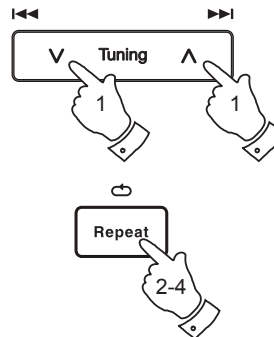

Repeat a single track

2. While the CD is playing, press the **Repeat** button until the repeat single track symbol (↺) appears in the display. The current track will be repeated.

Repeat all tracks

3. While the CD is playing, press the **Repeat** button until the repeat all tracks symbol (↻) appears in the display. All of the tracks on the CD will be played repeatedly.

Play tracks introduction

4. While the CD is playing, press the **Repeat** button until the track introduction symbol (**INTR**) appears in the display. The first 10 seconds of each track will be played. When the desired track is reached, press the **Repeat** button once more to revert to normal play mode.

Shuffle tracks

5. While the CD is playing, press the **Random** button (on the remote control) until the shuffle symbol (⌂) appears in the display. The tracks will be shuffled. To cancel the shuffle function, press the **Random** button a second time.



CD track programming

In addition to playing of complete CDs, selected tracks, or a random selection, the CD player allows you to programme a sequence of up to 20 tracks to be played in whatever order you choose.

1. With the unit in CD mode and with a CD inserted, make sure that the CD is stopped (press the **Stop** button).
2. To enter programming mode, press the **Auto** button (on the remote control).
3. Choose the first track using the **Fast-forward** or **Rewind** buttons.
4. Press the **Auto** button to enter the selected track into the programme.
5. Choose another track using the **Fast-forward** or **Rewind** buttons, and enter it into the programme using the **Auto** button (track 10 in example shown).
6. Repeat step 5 to store as many as 20 tracks in the programme.
7. When the programme is complete, press the **Play / Pause** button to start playing. The tracks will then be played in the order that you have just programmed.
8. Pressing the **Stop** button, or switching to another operating mode will erase the programme.

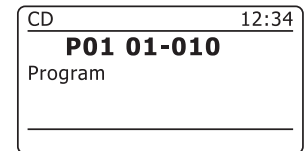
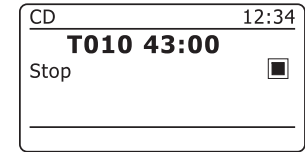
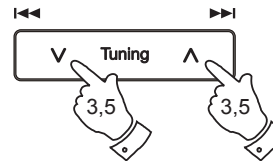
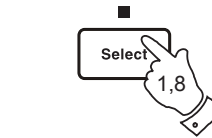

Note: If you are programming the tracks using a CD with MP3 or WMA files in folders (see the following pages), you can also use the **Up** or **Down Folder** buttons to specify the folder in steps 3 and 5 above.

MP3 / WMA CD Mode

The Stream 64i is able to play CD-R and CD-RW discs containing MP3 and WMA files. It is assumed in this section that a file is equivalent to a CD track.

An MP3 / WMA CD may not contain more than 512 files and not more than 99 folders. MP3 and WMA files should be created with an audio sample rate of 44.1kHz (this is normal for files created from CD audio content). MP3 and WMA data rates up to 320 kilobits per second are supported. WMA Lossless files are not supported. The unit will not play files which include digital rights management (DRM) protection.

When burning CD-R and CD-RW discs with audio files, various problems may arise which could lead to problems with playback. Typically such problems are caused by poor CD writing or audio encoding software, or by the hardware settings of the PC's CD writer, or by the CD being used. Should such problems arise, contact the customer services of your CD writer or software manufacturer or look in their product documentation for relevant information. When you are making audio CDs, take care to observe all legal guidelines and ensure that the copyright of third parties is not infringed.

1. To select the CD mode press the **Media** button until 'CD' shows on the display, or insert a suitably prepared CD-R or CD-RW disc.
2. Insert a CD with printed side facing up into the CD slot. The disc will be loaded automatically. The unit will check the CD type and load its track list. The display will show "loading" and then "reading" as the information is read.

If there are many files or folders on the CD then it may take some tens of seconds to read all of the file and folder names and to identify those which are playable (with .mp3 or .wma filename extension).

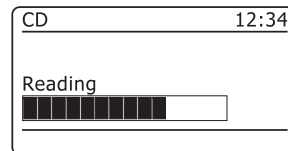
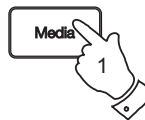

Playing an MP3 / WMA CD

1. Press the **Play/Pause** button to start playing from the CD. The display will show the first folder and file numbers - "01" and "001".
2. To pause playing press the **Play/Pause** button. To resume playing press the **Play/Pause** button again.
3. To stop play, press the **Stop** button. The total number of files on the disc and 'Stop' will be displayed.
If you put the unit into standby mode without pressing the Stop button, then the next time the unit is switched on it will return to the previously played file.
4. To take out the CD, press the **CD Eject** button. The display will show 'Eject'. In order to protect the disc if it is not removed, the unit will reload the disc after 10 seconds and then enter standby mode. To reload a CD that has just been ejected, press the **Eject button** a second time.

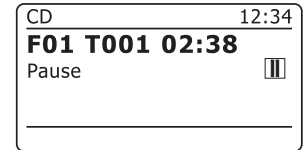
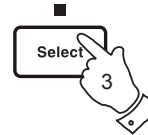
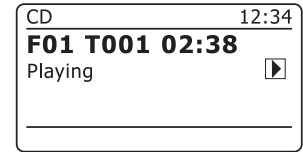
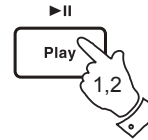

Selecting a file

1. While the CD is playing, press either the **Fast-forward** or **Rewind** buttons to change to the desired file. The file number is updated in the display. If there is more than one folder, when all files in the current folder have been played the next folder will be played.
2. You can also skip files when the player is in stop mode. Skip to the desired file using the **Fast-forward** or **Rewind** buttons and release the button when the desired file number is displayed.
3. Press the **Play/Pause** button to play the selected file.

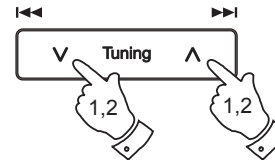

Select a specific file

1. For file numbers 1-9 simply press the corresponding digit button. For file numbers ten and above press the required digits using the 10/0 button to enter the digit zero.
3. If the file number entered exceeds the number of playable files on the CD, then the last file will be played.

File numbers up to 512 may be entered. The numbers of files in folders are added together. So, for example, if the first two folders each contain 10 files, then entering 15 will play the fifth file in the second folder.

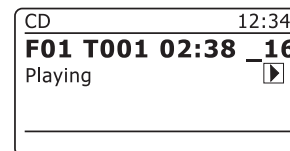
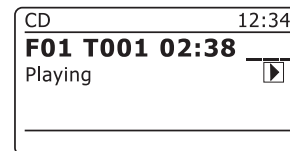
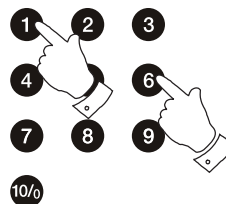

Search function

1. While the MP3 / WMA CD is playing, press and hold the **Fast-forward** or **Rewind** buttons. Release the button when the desired part of the current file is reached.

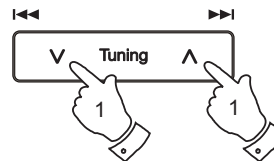

To skip to another folder

1. With the MP3 / WMA CD in stop or play mode, press and release either the **Up** or **Down Folder** buttons (on the remote control). The first file of the next or previous folder will be played.

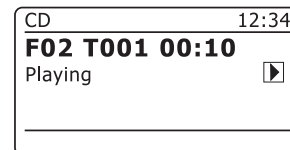
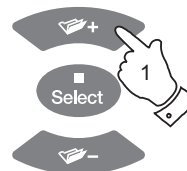

Repeat, Intro, shuffle and Programmed play

The Stream 64i allows you to use the same playback options for files as can be used for conventional audio CDs (see pages 63-66). In addition to Repeat Once and Repeat All options, there is also a Repeat Folder facility.

Display modes

Your radio has a range of display options when in MP3 / WMA CD mode. Note that not all information may be available for all files.

1. Press the **Info** button to cycle through the different options.
 - a. Progress Displays the playback progress for the track currently playing.
 - b. File name Displays the file name and audio format of the track currently playing.
 - c. Album Displays the name of the album from which the current track is taken.
 - d. Artist Displays the name of the artist for the currently playing track.
 - e. Title Displays the title of the currently playing track.

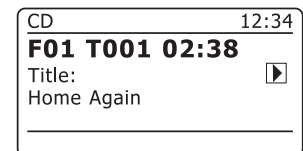
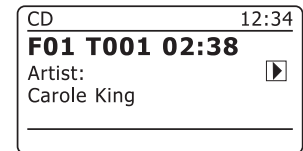
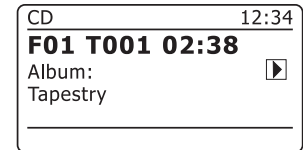
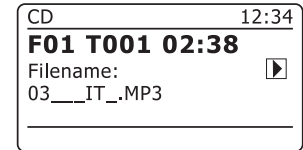
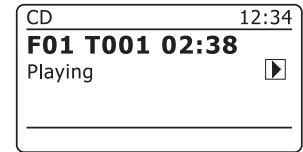
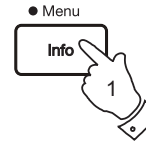

Using SD cards or USB memory devices

This section describes how to use your radio to access and playback your audio files via USB memory devices and Secure Digital (SD, SDHC) cards. The Stream 64i can also record to SD, SDHC or USB media in MP3 format.

Important: *Your radio is only designed to work with USB memory flash memory devices. It is not intended to be connected to hard disk drives or any other type of USB device.*

The Stream 64i has been tested with a range of USB memory devices of up to 64GB capacity and SD cards up to 2GB and SDHC cards upto 32GB are supported. However, there are many different card variants available and not all cards can be guaranteed to work in the Stream 64i. Memory must use the FAT 32 filing system in order to operate in the Stream 64i.

Audio formats supported for playback are MP3 and WMA. Playback does not support files encoded using WMA lossless, WMA Voice, WMA 10 professional, nor files of any format which have DRM protection.

SD card and USB slots are located behind the front panel beneath the touch panel. This is opened by pushing and releasing the right hand corner of the panel. To close the panel, press the right-hand side of the panel door until it clicks back into place.

Do not attempt to open or close the panel door using the left hand edge as this may distort or damage the panel.

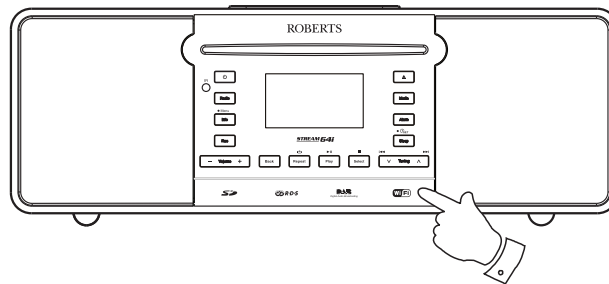

Cautions:

In order to minimise the risk of damage to your radio, your SD card or your USB memory, please place the unit such that the device cannot easily be knocked while it is inserted in the socket.

Remove the USB memory or SD card before carrying the unit or if not using the USB or SD feature for a prolonged period.

Place the unit in Standby mode before removing your SD card or USB memory device.

Inserting and removing memory devices

1. To insert an SD card into your radio push the card label side upward and gold contacts first into the card slot on the front of your radio until it clicks. To remove the card push the card in so that it clicks once more. It will then be pushed out slightly allowing removal.

USB memory devices plug into the rectangular slot on the right hand side, behind the front panel.

Note: that the USB socket is upside down compared to those commonly found on PCs.

2. To select either SD card or USB mode press the **Media** button until the desired mode is shown on the display.

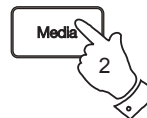

Playing MP3 / WMA files - SD / USB

1. Press the **Play / Pause** button to start playing from the SD card / USB memory device. The display will show the first folder and file numbers - "01" and "001".
2. To pause playing press the **Play / Pause** button. To resume playing press the **Play / Pause** button again.
3. To stop play, press the **Stop** button. The total number of files and folders on the media and the stop symbol (■) will be displayed.

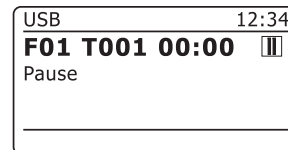
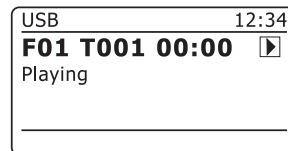
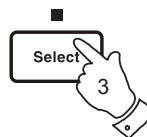
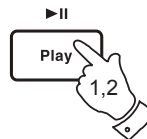

If you put the unit into standby mode without pressing the Stop button, then the next time the unit is switched on it will return to the previously played file.

Selecting a file

1. While the SD card / USB memory device is playing, press either the **Fast-forward** or **Rewind** buttons to change to the desired file. The file number is updated in the display. If there is more than one folder, when all files in the current folder have been played the next folder will be played.
2. You can also skip files when the player is in stop mode. Skip to the desired file using the **Fast-forward** or **Rewind** buttons and release the button when the desired file number is displayed.
3. Press the **Play / Pause** button to play the selected file.

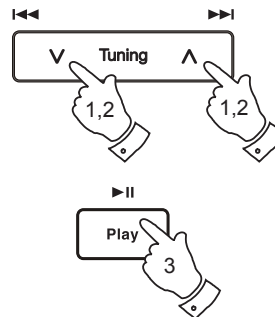

Select a specific file

1. For file numbers 1-9 simply press the corresponding digit button. For file numbers ten and above press the required digits using the 10/0 button to enter the digit zero.
3. If the file number entered exceeds the number of playable files on the SD card / USB memory device, then the last file will be played.

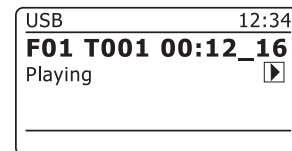
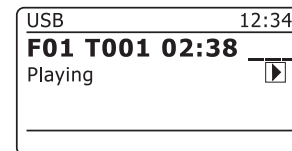
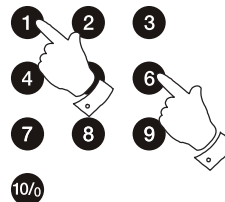

File numbers up to 512 may be entered. The numbers of files in folders are added together. So, for example, if the first two folders each contain 10 files, then entering 15 will play the fifth file in the second folder.

Search function

1. While the SD card / USB memory device is playing, press and hold the **Fast-forward** or **Rewind buttons**. Release the button when the desired part of the current file is reached.

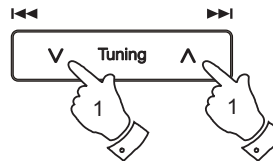

To skip to another folder

1. With the SD card / USB memory device in stop or play mode, press and release either the **Up** or **Down Folder** button (on the remote control). The first file of the next or previous folder will be played.

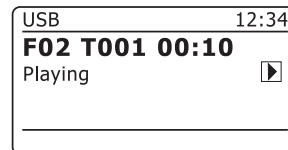
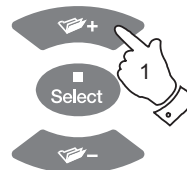

Repeat, Intro, shuffle and Programmed play

The Stream 64i allows you to use the same playback options for files as can be used for conventional audio CDs (see pages 63-66). In addition to Repeat Once and Repeat All options, there is also a Repeat Folder facility.

Recording to SD / USB

Your Stream 64i radio has been designed to allow you to make recordings to SD / SDHC cards or to USB connected memory devices. Recordings are made in MP3 format at 128k bits per second.

SD/SDHC or USB memory media must use the FAT32 file system in order to operate with the Stream 64i. Such media is usually supplied already formatted or can be formatted using a PC with a suitable card reader (for SD/SDHC cards) or USB connection (for USB memory).

It is possible to record onto media which already contains files written by the radio or using your computer. The recorded files will be added to those already present on the media.

Making a recording

1. Select the desired source for the recording (Internet Radio, DAB, FM, CD, etc.). Internet Radio is shown in the illustration. Set the volume to the required listening level (the volume of the recording will not be affected by this).
2. Insert the media on to which the recording is to be made.
3. Press the **Record** button. The display will show "Record initial...". Recording will then start with the recording source shown on the display.

If only one media type is present, then after a short while recording will start. If both SD and USB media are detected, then the radio will default to the option previously set. The default media option is accessed through the 'System settings' menu then by selecting 'Rec default dest.'. Select 'SD card' or 'USB' memory as needed.

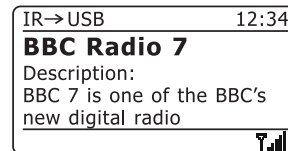
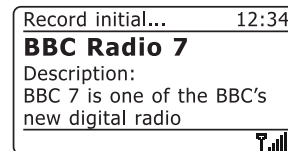

Making a recording cont.

If recording from a CD, recording will be started from the beginning of the currently playing track. Each track on the CD will be recorded as a separate file on the media.

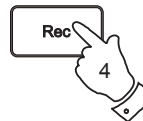

- In order to stop the recording press the **Record** button once more. Recording will stop and a file will have been written to the storage media.

Files that have been written to the media are held in a folder called "RECORD". Recordings are held in sub-folders according to the source used for the recording.

The illustration shows the folders as they may appear on a PC running Windows with files in the CD folder being shown to the right.

Note: The SD card / USB memory device should only be removed when recording is stopped. Removing media while recording is in progress may corrupt data on the card leading to the loss of files previously written.

The USB connection is primarily intended to be used to allow the Stream 64i to play MP3 and WMA files from solid-state flash memory devices. You may be able to play files which have been stored on a USB hard disc drive (but the drive must have its own power supply). If you wish to play files from another music player, then we recommend that this is connected to the Auxiliary input socket - see page 98.

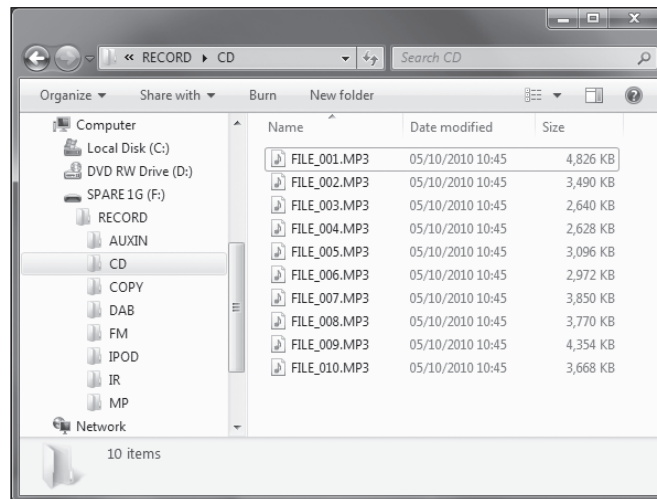
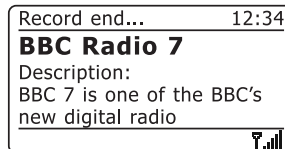

Recording MP3 / WMA files from CD / SD / USB

In addition to recording from conventional sources, the Stream 64i radio can also record from MP3 or WMA files that have previously been written to CD, SD or USB media. In this case the files are copied rather than re-encoded to MP3 in order to avoid a reduction in quality. You may copy files from CD or SD to USB and from CD or USB to SD.

1. Select the desired source for the recording (SD, USB or CD).
2. Press the **Play** button to start playing the source media (if it does not automatically start). Set the volume to the required listening level (the volume of the recording will not be affected by this).
3. Insert the media that the files will be recorded on to (SD or USB).
4. Press the **Record** button. The display will show "Record initial...".
5. If only one media type is present, the audio will stop while the source media is taken back to the beginning of the current file. Recording will then start.
6. If both SD and USB media are detected, then the radio will default to the option previously set. The default media option is accessed through the 'System settings' menu then by selecting 'Rec default dest.'. Select 'SD card' or 'USB' memory as needed. The source media will be taken back to the beginning of the current file and recording will then start.
7. In order to stop the recording press the **Record** button once more. Recording and playback will stop and all files that have been played will have been copied to the storage media.

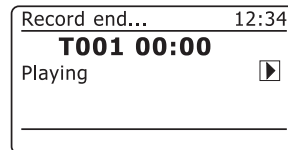
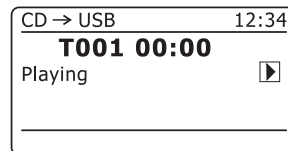
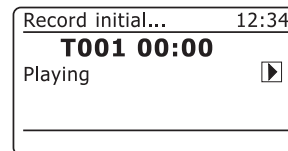
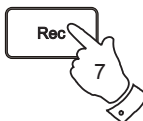
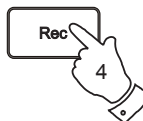
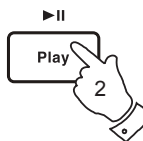
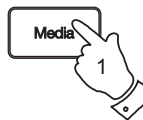

Deleting files

After having recorded files to SD or USB media, you may later wish to delete them in order to reclaim the space used. The Stream 64i can be used to delete individual files, or to delete all of the media files on the media.

Deleting a single file

1. With the radio in USB or SD mode, and with the media inserted and the file you wish to delete is currently playing, **press and hold** the **Menu** button.
2. Press the **Menu Up** or **Down** buttons until 'Delete this file' is highlighted on the display.
3. Press the **Select** button. The display will ask you if you wish to 'Delete this file?'
4. If you do not wish to delete the file, use the **Menu Up** or **Down** button to highlight 'NO' and press the **Select** button to confirm.

Alternatively, to delete the file use the **Menu Up** or **Down** button to highlight 'YES' and press the **Select** button to confirm deletion.

The file will be deleted and the details of the next file will be displayed. If there are no more files left on the media, then the display will show 'No Music File'.

Note: Once a file has been deleted, it is not possible to recover the file.

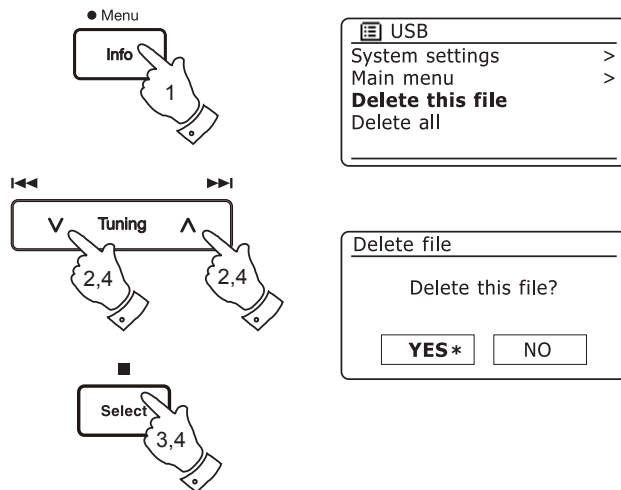

Deleting files cont.

Deleting all files

1. With the radio in USB or SD mode, and with the media inserted **press and hold** the **Menu** button.
2. Press the **Menu Up** or **Down** buttons until 'Delete all' is highlighted on the display.
3. Press the **Select** button. The display will ask you if you wish to 'Delete all files?'
4. If you do not wish to delete all the files, use the **Menu Up** or **Down** button to highlight 'NO' and press the **Select** button to confirm.

Alternatively, to delete all the files on the media use the **Menu Up** or **Down** button to highlight 'YES' and press the **Select** button to confirm deletion.

All the files will be deleted. If there are no more files left on the media, then the display will show 'No Music File'.

The operation will generally only take a few seconds. When completed, the display will show 'No Music File'.

Note: Once the files have been deleted, it is not possible to recover the previous contents.

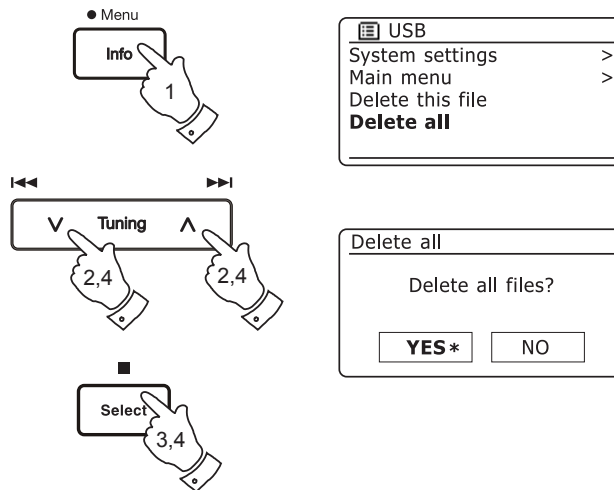

Your Stream 64i radio has an iPod dock facility which allows you to play digital audio files and video soundtracks held on your iPod directly.

The Stream 64i uses the Universal Dock Connector developed for use with iPods. Most recent models of iPod are supplied with adaptor inserts which ensure correct alignment of the iPod with the electrical connector. Earlier models of iPod were not supplied with the necessary inserts, and so your Stream 64i is supplied with insert types 1 - 7. Should you require an insert to use your iPod with the Stream 64i, then please contact an iPod accessories supplier.

1. Ensure that the radio is in standby. Carefully remove the iPod dock connector cover from the top of your radio.
2. Place the iPod docking adaptor (see above) into the iPod docking recess so that it is securely seated.
3. Carefully place your iPod on the universal iPod dock connector then press the **On/Standby** button to switch on the radio. **To avoid possible damage to either device, do not use your iPod without the correct adaptor fitted in the dock connector.**
4. To select the iPod mode press the **Media button** until 'iPod' shows on the display. If it was previously playing, your iPod will switch on and continue playing from where it was previously stopped.

Note: The Stream 64i radio is able to recharge your iPod's internal battery. Recharging does not take place while your Stream 64i is using DAB or FM radio.

Your iPod will use its backlight settings as configured. If these need changing, use the iPod's *Settings* menu.

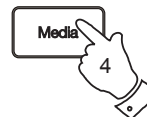
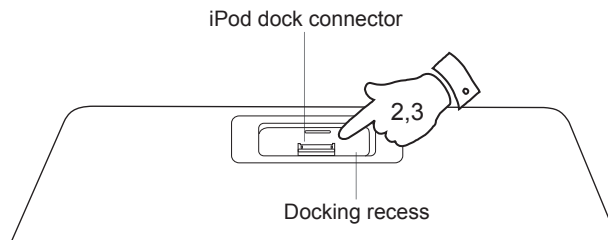

Navigating your iPod

1. Use the **Menu** button on the remote control to navigate to higher level menus on your iPod.
2. Use the **Folder Up** or **Down** buttons on the remote control as required to move up and down a menu screen on your iPod.
3. Press the **Select** button to choose the highlighted on screen menu item. If this item is a lower level menu item, you may then navigate further using the **Folder Up** or **Down** and **Select** buttons.

Note: iPod models vary in how they respond to the menu button. Not all iPods allow full menu navigation.

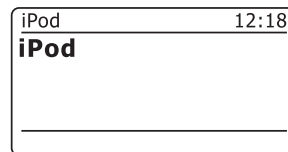
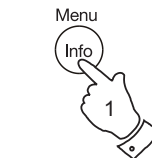

Playing a file on your iPod

1. When you have found the required item use the **Select** button to start the iPod playing (or the **Play / Pause** button - but see note below).
2. Adjust the volume to the required setting using the **Volume** buttons on your radio.
3. To pause playback press the **Play / Pause** button. To resume playback press the **Play / Pause** button again.
4. iPod's do not have a Stop button (they use the Pause function). To play an alternative selection, use the iPod menus to make the selection using the **Play / Pause** button to stop playing the current item if needed.

Note: iPods vary in how they respond to the **Play / Pause** button dependent upon the iPod model and software revision. Play / Pause may pause and resume the current selection, or it may pause the current selection and then start playing a new selection. The use of the **Select** button to start playing an item avoids this inconsistency.

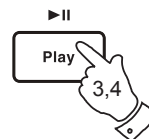
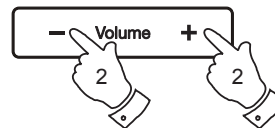

Search function

1. While the iPod is playing, press and hold the **Fast-forward** or **Rewind** buttons.
2. Release the button when the desired part of the item is reached.

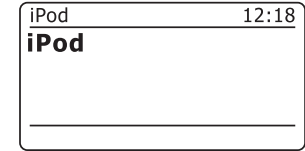
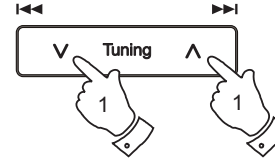

Repeat a single file

1. While the iPod is playing, press the **Repeat** button until the repeat single file symbol appears in the iPod display. The currently playing item will be repeated.

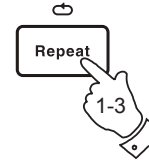

Repeat all

2. While the iPod is playing, press the **Repeat** button until the repeat all files symbol appears in the iPod display. All files in the current album or playlist will be repeated.

Repeat cancel

3. While the iPod is playing, press the **Repeat** button until the repeat symbol is removed from the iPod display. Remaining files in the current album or playlist will be played.

Shuffle

4. While the iPod is playing, press the **Random** button to control the shuffle symbol in the iPod display. The tracks in the current album or playlist will be shuffled when shuffle is enabled.



Clock and Alarms

Automatically updating the clock

Your radio will normally update the clock automatically when connected to the internet. If you enter a time setting manually, the radio will calculate a local time offset which is then stored in memory. Whenever it synchronises the clock using the internet, including after a power failure, your radio will then set the clock automatically using this information.

You may wish to use the radio away from the internet, in which case you may specify that the unit sets its clock from DAB or FM radio broadcasts. After a power failure the radio will then set its clock the next time that you turn on the radio in DAB or FM mode.

Alternatively you may specify that the time is not automatically updated. In this case the clock must always be set manually after a power interruption.

1. With your radio switched on, **press and hold** the **Menu** button to access the menu for the current mode.
2. Press the **Menu Up** or **Down** buttons until 'System settings' is highlighted on the display. Press the **Select** button to enter the system settings menu.
3. Press the **Menu Up** or **Down** buttons until 'Time/Date' is highlighted on the display. Press the **Select** button to enter the time setup.
4. Press the **Menu Up** or **Down** buttons until 'Auto update' is highlighted on the display. Press the **Select** button to enter the auto-update menu.
5. Press the **Menu Up** or **Down** buttons to choose an update option from 'Update from DAB', 'Update from FM', 'Update from Network' or 'No update' as required. Press the **Select** button to confirm your choice. The radio will then exit to the previous menu display.

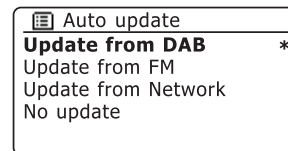
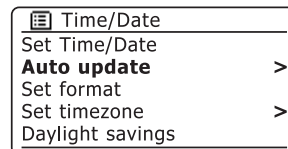
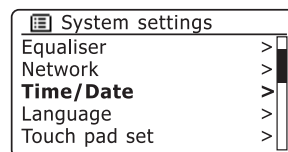
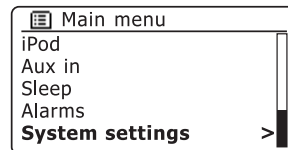
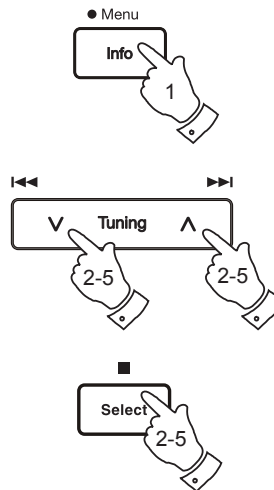

Setting the clock format

The clock display used in standby mode and on the playing mode screens can be set to 12 or 24 hour format. The selected format is then also used when setting the alarms.

1. With your radio switched on, **press and hold** the **Menu** button to access the menu for the current mode.
2. Press the **Menu Up** or **Down** buttons until 'System settings' is highlighted on the display. Press the **Select** button to enter the system settings menu.
3. Press the **Menu Up** or **Down** buttons until 'Time/Date' is highlighted on the display. Press the **Select** button to enter the time setup.
4. Press the **Menu Up** or **Down** buttons until 'Set format' is highlighted on the display. Press the **Select** button to enter the clock format menu.
5. Press the **Menu Up** or **Down** buttons to select either 12 or 24 hour format. Press the **Select** button to confirm your choice of clock format. The display will then revert to the previous menu.

If the 12 hour clock format is chosen, the radio will then use the 12 hour clock for the setting of alarms, and will display a 12 hour clock with an AM or PM indicator when in standby mode.

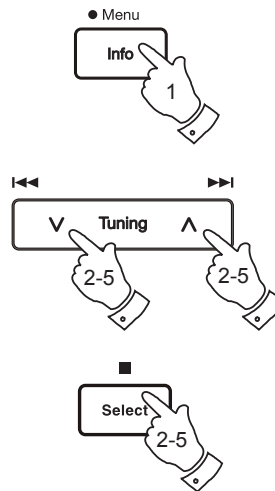

Clock and Alarms

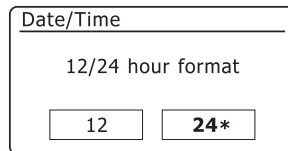
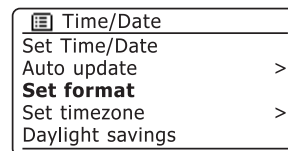
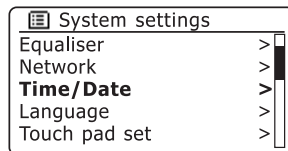
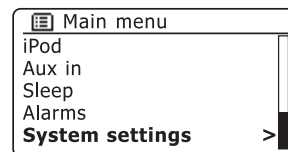

Manually setting the clock

The Stream 64i radio will normally set its clock automatically to UK time after a connection to the Internet has been established. Should you need to set the time manually, change the time zone, or manually switch from winter to summer time (GMT to BST - also known outside the UK as daylight savings time), then please follow this procedure.

1. Press the **On/Standby** button to switch on your radio. To set the time and date **press and hold** the **Clock/Set** button then follow steps 6 to 10.
2. To set all time settings **press and hold** the **Menu** button to access the menu for the current mode.
3. Press the **Menu Up** or **Down** buttons until 'System settings' is highlighted on the display. Press the **Select** button to enter the system settings menu.
4. To change the time zone setting go to step 11.
To change from winter to summer time go to step 13.
To change the current time or date setting press the **Menu Up** or **Down** buttons until 'Time/Date' is highlighted on the display, then press the **Select** button to enter the time and date setting screen.
5. Press the **Menu Up** or **Down** buttons until 'Set Time/Date' is highlighted on the display. Press the **Select** button to enter the clock setup. The day digits will flash.
6. Press the **Menu Up** or **Down** buttons until the correct day is shown on the display. Press the **Select** button to enter the selection. The month digits will then flash.
7. Press the **Menu Up** or **Down** buttons to select the correct month. Press the **Select** button. The year digits will then flash.

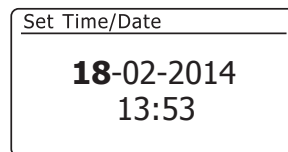
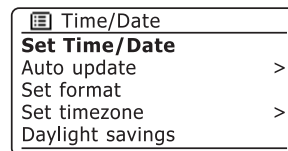
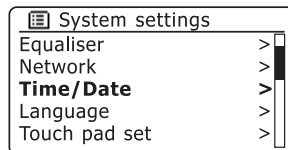
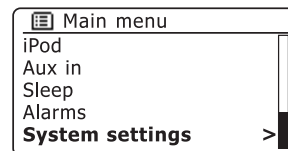
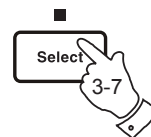
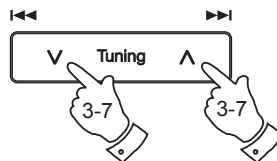
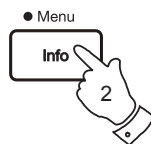

Manually setting the clock - cont.

8. Press the **Menu Up** or **Down** buttons to select the correct year. Press the **Select** button to enter the selection. The hour digits will then flash.
9. Press the **Menu Up** or **Down** buttons to select the correct hour. Press the **Select** button to enter the selection. The minute digits will then flash.
10. Press the **Menu Up** or **Down** buttons to select the correct minutes. Press the **Select** button to enter the selection. The display will then return to the previous menu.
11. Press the **Menu Up** or **Down** buttons until *'Set timezone'* is highlighted on the display then press the **Select** button.
12. Press the **Menu Up** or **Down** buttons to highlight the time zone which is applicable to your location, then press the **Select** button to confirm the setting. **Press and hold** the **Menu** button to exit or go to step 13 to set the summer / winter time option.
13. Press the **Menu Up** or **Down** buttons until *'Daylight savings'* is highlighted on the display then press the **Select** button. The asterisk shows the current setting.
In the UK, ON is equivalent to British Summer Time, OFF is equivalent to Greenwich Mean Time.
14. Press the **Menu Up** or **Down** buttons to highlight *'ON'* or *'OFF'* as required then press the **Select** button to confirm the setting.
15. **Press and hold** the **Menu** button to exit.

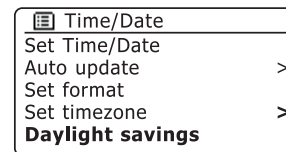
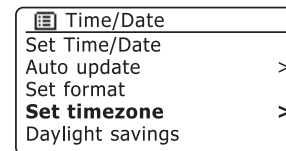
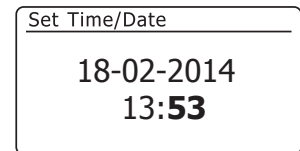
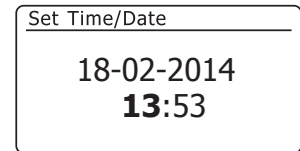
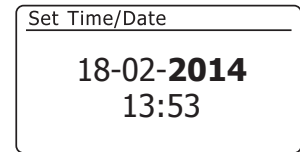
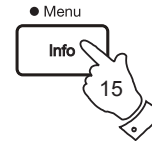
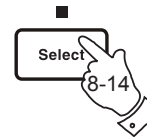
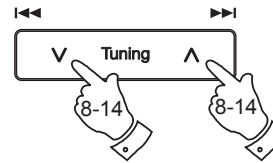

Setting the alarm clock

Your radio has two separate alarms which can be set to wake you to either the radio, CD, USB, SD, iPod or a buzzer alarm. In the event of a power interruption your radio has built in memory that will retain your alarm settings. Ensure that the time is set correctly before setting the alarms.

1. Press the **Alarm** button to see the current alarm settings. If no change is required, **press and hold** the **Menu** button or press the **Back** button to exit. The Alarm menu can also be accessed using the 'System settings' menu.
2. Press the **Menu Up** or **Down** buttons until the desired alarm (1 or 2) is highlighted on the display. Press the **Select** button to enter alarm setup.
3. Press the **Menu Up** or **Down** buttons until 'Time' is highlighted on the display. Press the **Select** button to adjust the alarm time.
4. Press the **Menu Up** or **Down** buttons to choose the alarm hour. Press the **Select** button to confirm the setting.
5. Press the **Menu Up** or **Down** buttons to choose the alarm minute. Press the **Select** button to confirm the setting. The display will then return to the alarm setting menu.

If the radio has been set to use a 12 hour clock format, there will also be an option here for setting AM or PM for the alarm time.

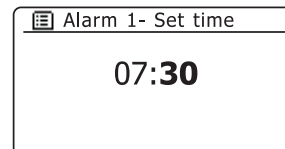
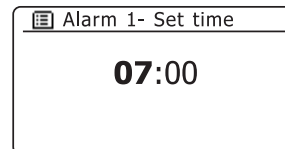
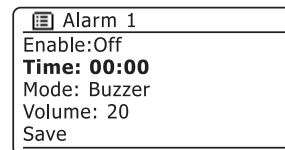
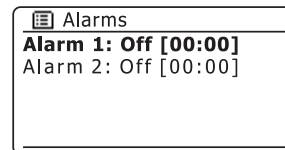
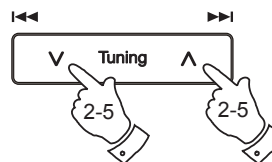
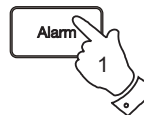

Setting the alarm clock - cont.

6. Press the **Menu Up** or **Down** buttons to highlight 'Enable' and press the **Select** button. The display will show the Frequency options for the alarm. The alarm frequency options are as follows:

'Off' - the alarm will be disabled

'Daily' - the alarm will sound everyday

'Once' - the alarm will sound once

'Weekends' - the alarm will sound only at weekends

'Weekdays' - the alarm will sound on weekdays only

Press the **Menu Up** or **Down** buttons to choose the required alarm frequency option. Choosing Off will disable the alarm. Press the **Select** button to confirm the selection.

If you choose to set the alarm to Once you will also need to set the date using the **Menu Up** or **Down** and **Select** buttons.

7. The alarm can be set to buzzer, Internet radio, DAB radio, FM radio, CD, USB, SD and iPod. For whichever radio mode is selected, the radio alarm may be set to any of the stations which have been stored as presets or to the station most recently listened to.

Press the **Menu Up** or **Down** buttons to highlight the current 'Mode' option for the alarm, then press the **Select** button if you wish to change it.

Press the **Menu Up** or **Down** buttons to highlight either 'Buzzer' or the required mode. Press the **Select** button to confirm the selection.

8. If setting the alarm to a radio option, Press the **Menu Up** or **Down** buttons to highlight the 'Preset:' option then press the **Select** button if you wish to change it.

Choose from either the radio station 'Last listened' to, or from the presets 1 - 10. Scroll to the chosen option and press the **Select** button to confirm the selection. Note that you can only set the alarm to use a preset which has already been stored.

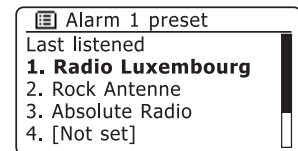
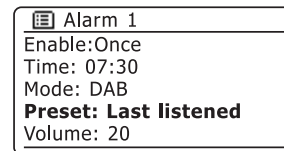
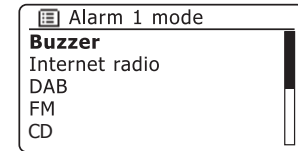
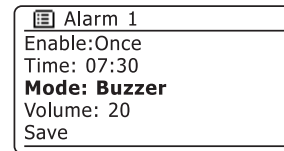
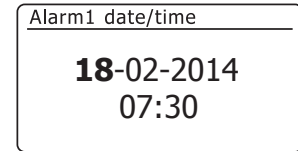
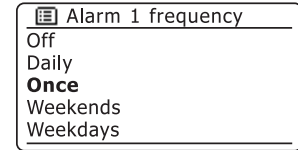
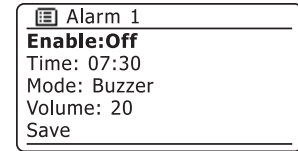
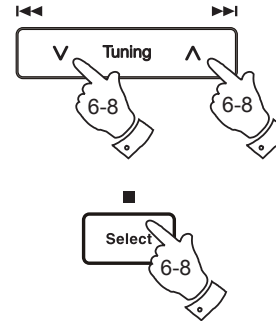

Setting the alarm clock - cont.

9. Press the **Menu Up** or **Down** buttons until the 'Volume:' option is highlighted on the display and press the **Select** button if you wish to change it. The radio uses the saved volume setting for each alarm when it sounds.

Set the required volume using the **Menu Up** or **Down** buttons and the **Select** button to confirm the setting.

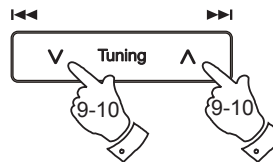

10. In order to store the alarm settings press the **Menu Up** or **Down** buttons until 'Save' is highlighted. Press the **Select** button to store the alarm settings. Your radio will show 'Alarm saved' and will then go back to the list of alarms with the new alarm setting shown in the display.

If you decide not to save the settings, press the **Back** button. The display will show 'Save changes' with a 'YES' or 'NO' option. press the **Menu Up** or **Down** buttons to choose 'NO' and then press the **Select** button. 'Alarm not saved' will show on the display.

Active alarms are shown using small alarm indicators at the bottom of the playing displays and on the clock display when in standby.

Note: If you make a mistake at any point while setting the alarms, use the **Back** button to go back to the previous screen.

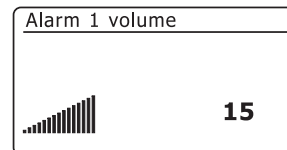
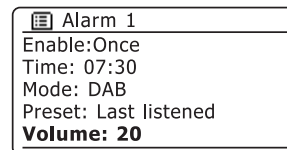

When the alarm sounds

The buzzer or radio alarm will sound at the selected times for up to 60 minutes unless cancelled. The volume used for the alarm will be as specified during the alarm setting procedure. If the radio cannot connect to the specified radio station, the buzzer alarm will be used instead.

To cancel an alarm, press the **On/Standby** button to return to standby mode.

The alarm icon will flash at the bottom of the playing mode displays, and the radio will automatically switch back to standby mode when the 60 minutes have elapsed.

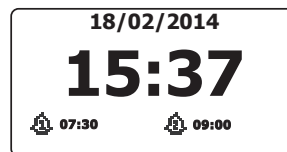
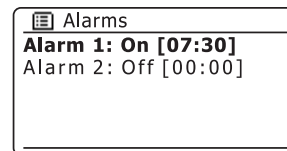

Disabling alarms

1. To disable a single alarm enter the alarm setup menu (see page 87) and press the **Menu Up** or **Down** buttons until the desired alarm is highlighted on the display. Press the **Select** button.
2. Press the **Menu Up** or **Down** buttons until the 'Enable:' option is highlighted on the display. Press the **Select** button.
3. Press the **Menu Up** or **Down** buttons to highlight 'Off' and press the **Select** button.
4. Press the **Menu Up** or **Down** buttons until the 'Save' option is highlighted on the display then press the **Select** button to save the new setting.
The chosen alarm will now be disabled.

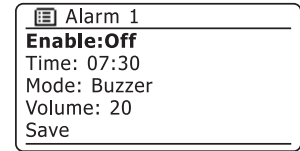
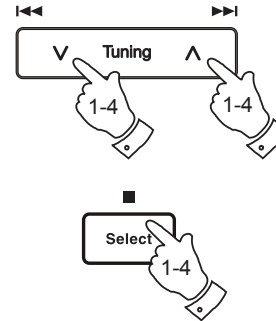

Controlling alarms in standby

When your radio is in standby the alarms can be controlled using the **Alarm** button. This avoids the risk of disturbance to someone who is asleep.

1. To change the states of the alarms when in standby press the **Alarm** button. The display will cycle through none, either and both alarms enabled.



Snooze timer

1. The buzzer or radio alarm can be silenced for 5 minutes by pressing the **Alarm** button. Should you wish for a longer snooze duration this can be extended. Pressing the **Alarm** button again while the radio is snoozed will set the available snooze time to 5, 10, 15 or 30 minutes.
2. While the snooze timer is active the remaining snooze time is shown next to the flashing alarm icon on the clock display.
3. In order to cancel the Snooze timer while the alarm is suspended, press the **On/Standby** button. The display will briefly show an 'Alarm Off' message.



Sleep timer

Your radio can be set to turn off after a preset time has elapsed. The sleep timer setting can be adjusted between 15 and 120 minutes in 15 minute increments.

1. Press the **On/Standby** button to switch on your radio.
2. To use the sleep timer, press and release the **Sleep / Clock set** button to enter the sleep setup. 'Sleep off' will appear on the display.
3. Repeatedly press the **Sleep / Clock set** button to select the desired sleep time. The options are 15, 30, 45, 60, 75, 90, 105 or 120 minutes. Use the OFF option to cancel the sleep function.
4. Your radio will switch off after the preset sleep time has elapsed.

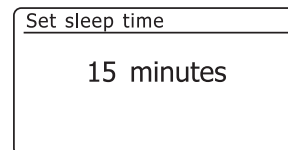

5. Your radio will switch into standby mode after the preset time has elapsed.

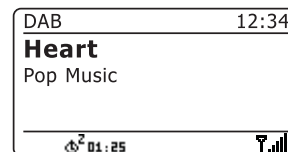

An active sleep timer is shown using a small timer indicator at the bottom of the playing displays. This indicator also shows the sleep time remaining before the radio switches itself into standby mode.

6. To cancel the sleep time before the preset time has elapsed and to turn off the radio, press the **On/Standby** button to turn the unit off manually.

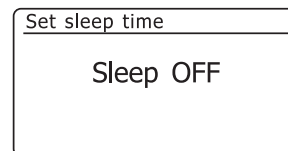

To cancel the sleep timer and leave the radio playing, go back into the sleep timer settings (steps 1 to 3 above) and select the Off option in step 3. Alternatively, simply press the **On/Standby** button twice in succession to cancel the timer and switch the radio back on again.

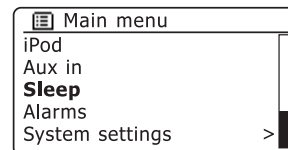

The sleep time can also be accessed from the main menu. Use the **Menu Up** or **Down** and **Select** buttons to set the sleep time.

Display and Audio

Equaliser function

The sound on your radio can be adjusted to suit your personal taste for the material that you are listening to. The Stream 64i has a range of equaliser modes. Alternatively you may set the treble and bass levels to your own preferences which can be accessed from the *My EQ* menu item.

1. Press the **On/Standby** button to switch on your radio. Access the menu for the current mode by **pressing and holding** the **Menu** button. Alternatively press the **EQ** button on the remote control and proceed to step 4.
2. Press the **Menu Up** or **Down** buttons until 'System settings' is highlighted on the display. Press the **Select** button to enter the system settings menu.
3. Press the **Menu Up** or **Down** buttons until 'Equaliser' is highlighted on the display. Press the **Select** button.
4. Press the **Menu Up** or **Down** buttons to cycle through and highlight the various modes. Press the **Select** button to confirm your selection.
 - a - 'Normal (Flat)'
 - b - 'Jazz'
 - c - 'Rock'
 - d - 'Movie'
 - e - 'Classic'
 - f - 'Pop'
 - g - 'News'
 - h - 'My EQ'

The currently selected mode is marked with an asterisk.

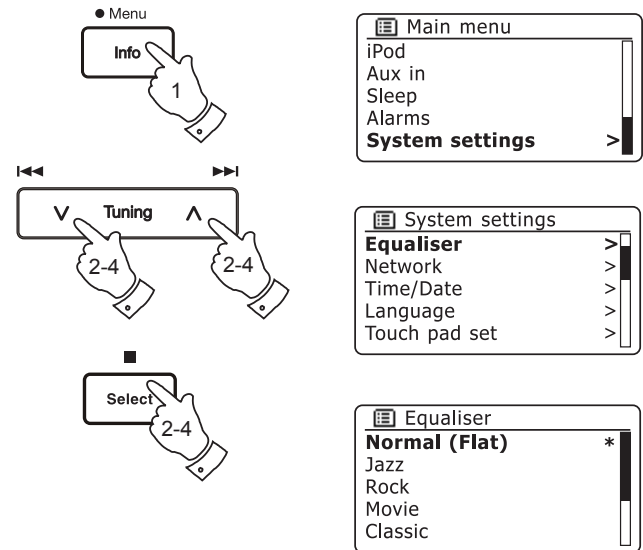

Setting up your My EQ profile

If you find the preset equaliser functions not to your liking, you may set up a custom treble and bass setting as follows:

1. Follow steps 1-3 on the preceding page in order to enter the Equaliser menu or alternatively press the **EQ** button on the remote control.
2. Press the **Menu Up** or **Down** buttons until 'My EQ profile setup' is highlighted on the display. Press the **Select** button to enter the adjustment mode.
3. To adjust the bass level press the **Menu Up** or **Down** buttons until 'Bass' is highlighted on the display. Press the **Select** button to enter the adjustment mode and press the **Menu Up** or **Down** buttons until the desired level (between -14 and +14) is displayed. The sound will change as you adjust the level. Press the **Select** button when you are happy with the bass setting.
4. To adjust the treble level press the **Menu Up** or **Down** buttons until 'Treble' is highlighted on the display. Press the **Select** button to enter the adjustment mode and press the **Menu Up** or **Down** buttons until the desired level (between -14 and +14) is displayed. The sound will change as you adjust the level. Press the **Select** button when you are happy with the treble setting.
5. Press the **Back** button and the display will prompt you to save the changes. If you wish to save the changes highlight 'YES'. If you do not wish to save the changes highlight 'NO'. Press the **Select** button to enter the selection.
6. To use the 'My EQ' profile press the **Menu Up** or **Down** buttons until 'My EQ' is highlighted, and then press the **Select** button to make the selection.

To quickly cancel the effect of the 'My EQ' profile press the **Menu Up** or **Down** buttons until 'Normal (Flat)' is highlighted on the display and press the **Select** button to select. The treble and bass settings will be remembered for the next time that you wish to use the 'My EQ' setting.

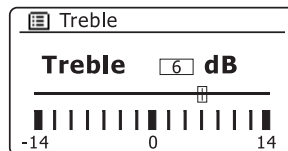
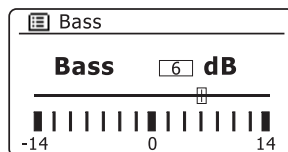
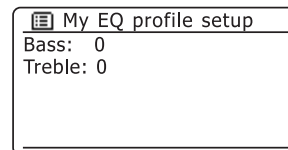
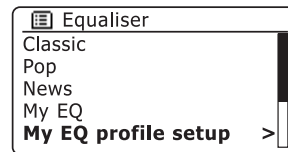
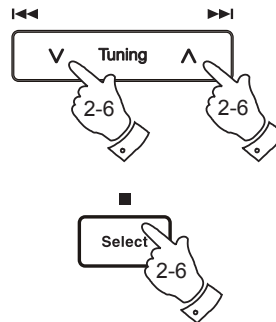

Brightness control

The brightness of the display can be adjusted for when the radio is in Standby and for when it is in use. If you use the unit in the bedroom, you may prefer a lower standby brightness level than the standard setting. There are three brightness levels and an almost off 'night-time' setting.

1. Press the **On/Standby** button to switch on your radio. Access the menu for the current mode by **pressing and holding** the **Menu** button.
2. Press the **Menu Up** or **Down** buttons until 'System settings' is highlighted on the display. Press the **Select** button to enter the system settings menu. Press the **Menu Up** or **Down** buttons until 'Brightness' is highlighted on the display. Press the **Select** button.
3. To adjust the display brightness when the radio is switched on press the **Menu Up** or **Down** buttons until 'Normal' is highlighted on the display. To adjust the display brightness when the radio is in standby press the **Menu Up** or **Down** buttons until 'Standby' is highlighted. Press the **Select** button to enter the selected brightness adjustment mode.
4. To adjust the brightness level press the **Menu Up** button on the radio to increase the brightness level and the **Menu Down** button to decrease it. The backlight level will change so that you can see the effect of each setting. Note that the backlight is almost completely off at the zero setting. Press the **Select** button to set the level.
Press and hold the **Menu** button to exit.

When the radio is in Standby mode, pressing a button will cause the radio to switch to the Normal brightness level for a few seconds. This is so that even if the Standby brightness level is set to zero (almost off), it is still possible to see the time by quickly pressing a button.

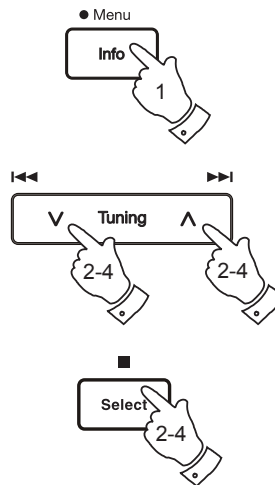

Display and Audio

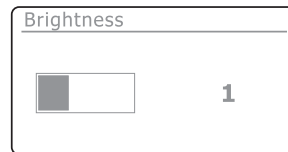
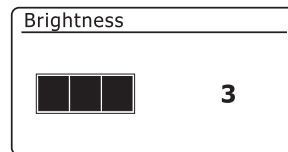
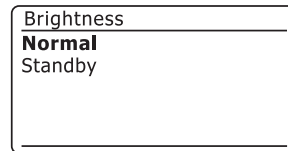
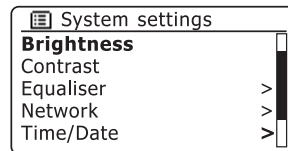
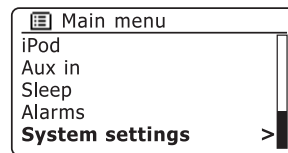

Contrast / viewing angle control

The contrast of the display can be adjusted. The adjustment also changes the angle from which the display can best be seen.

1. Access the menu for the current mode by **pressing and holding** the **Menu** button. Press the **Menu Up** or **Down** buttons until 'System settings' is highlighted on the display. Press the **Select** button to enter the settings menu.
2. Press the **Menu Up** or **Down** buttons until 'Contrast' is highlighted on the display and press the **Select** button.
3. Press the **Menu Up** or **Down** buttons to adjust the contrast and viewing angle. The contrast level indication on the screen will change at the same time. When you find the setting that gives the best legibility for the location in which the radio is used, press the **Select** button to save the setting.
4. **Press and hold** the **Menu** button to exit.

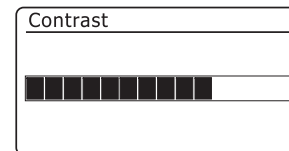
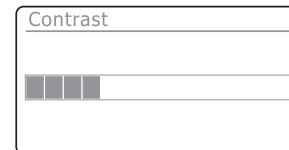
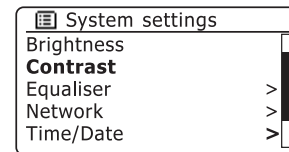
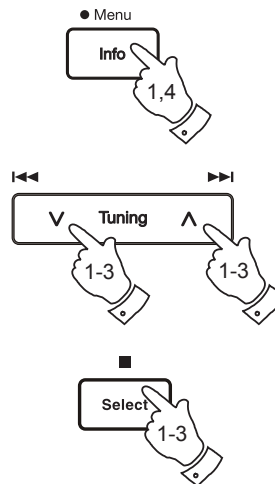

Mute function

Pressing the Mute button will mute the output from the loudspeakers.

1. Press the **Mute** button to mute the sound output.
2. Press the **Mute** button again or one of the **Volume** buttons to un-mute the sound output.



Touch panel sensitivity control

The sensitivity of the touch panel may be adjusted. The default setting will normally be found to provide satisfactory operation, however, the touch panel system may respond differently depending upon the moisture of the skin. The touch panel sensitivity may be set to low, normal or high.

1. Access the menu for the current mode by **pressing and holding** the **Menu** button.
2. Press the **Menu Up** or **Down** buttons until 'System settings' is highlighted on the display. Press the **Select** button to enter the system settings menu.
3. Press the **Menu Up** or **Down** button until 'Touch pad set' is highlighted on the display. Press the **Select** button to enter the adjustment mode.
4. Press the **Menu Up** or **Down** buttons to highlight the desired touch panel sensitivity level.
5. Press and release the **Select** button to save the new setting.

The default setting after a system reset is Normal.

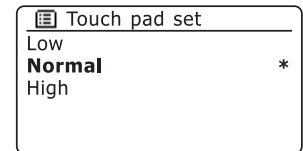
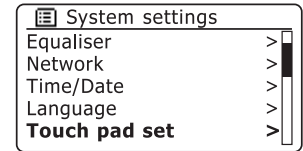
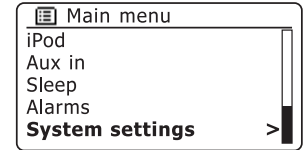
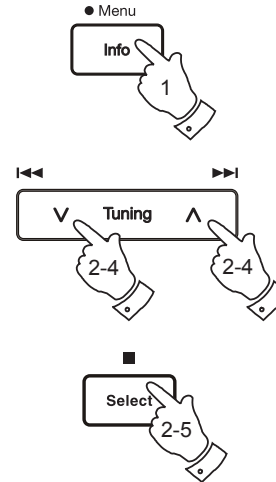

Headphone socket

A 3.5mm **Headphone Socket** located on the rear of your radio is provided for use with headphones. Inserting a plug automatically mutes the internal loudspeaker.

Please be aware that the sensitivity of headphones can vary widely. We therefore recommend setting volume to a low level before connecting headphones to the radio. It is also recommended to reduce the volume before unplugging your headphones.

IMPORTANT: Excessive sound pressure from earphones and headphones can cause hearing loss.



To prevent possible hearing damage, do not listen at high volume levels for long periods.

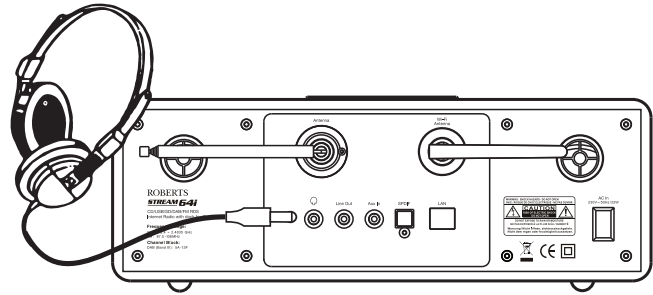

Line out socket (3.5mm Jack)

A 3.5mm **Line Out** socket located on the rear of your radio is provided for connecting the audio signal to an external amplifier. Inserting an audio cable into this socket will not mute the internal loudspeaker. Set the volume control on the radio to minimum if desired.

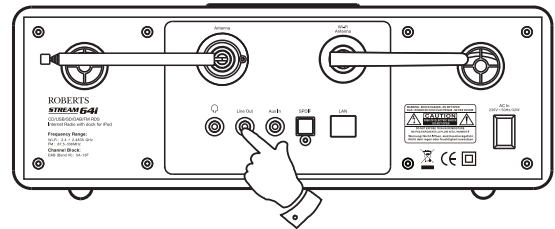

Auxiliary input socket

A 3.5mm **Auxiliary Input** socket located on the rear of your radio is provided for connecting the audio signal from an external audio source such as an MP3 or CD player.

1. Connect a stereo lead from the headphone output of your MP3 or CD player to the Aux In socket located at the rear of the radio. Typically this lead will have a 3.5mm stereo plug at both ends.
2. Switch on your radio.
3. Press the **Radio** button until 'AUX in' mode is shown on the display.
4. Press the 'play' on the connected audio device. If you are using its headphone output for the connection, set its volume control to a level of somewhere between two-thirds and maximum (the objective is to get a strong audio signal but without too much distortion). Then adjust the volume on the radio as required.
Note: if using an iPod as the sound source, you may need to set its output to maximum to get an adequate audio signal level.
5. After use, disconnect your player in order to listen to your radio conventionally.

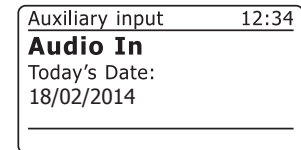
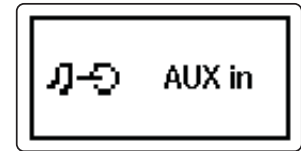
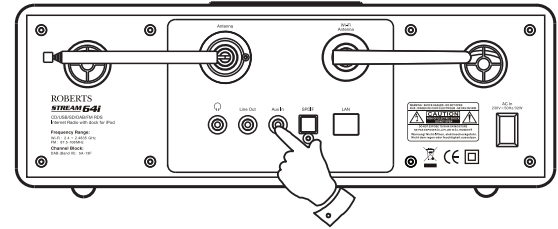

Optical S/PDIF output socket

A digital output socket providing an S/PDIF signal is provided on the rear of your radio for connection to an amplifier, mini-disc or other equipment with a digital optical input.

This feature is not active for iPod or AUX in modes.

Aerial removal

The fitted telescopic aerial is suitable for most applications. The telescopic aerial may be removed to allow connection to an external aerial using a coaxial cable.

First remove the two small screws holding the antenna connector cover in place (use a small cross-head screw driver). Then using the supplied spanner, remove the telescopic aerial by rotating in an anti-clockwise direction when viewed from the rear of the product.

This will expose an F-type connector to which an external aerial may be connected.

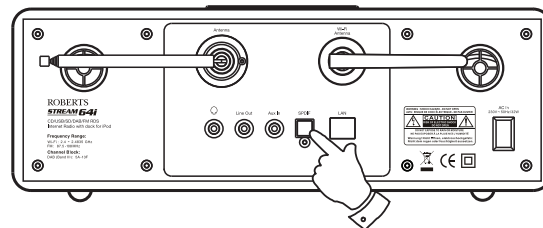

Factory reset

If you wish to completely reset your radio to its initial state this may be performed by following this procedure. By performing a factory reset, all user entered settings will be erased.

1. Access the menu for the current mode by **pressing and holding** the **Menu** button. Press the **Menu Up** or **Down** buttons to highlight the **'Main menu'** option, then press the **Select** button to select.

2. Press the **Menu Up** or **Down** buttons until **'System settings'** is highlighted and then press the **Select** button.

3. Press the **Menu Up** or **Down** buttons until **'Factory Reset'** is highlighted and then press the **Select** button. Press the **Menu Up** or **Down** buttons and to highlight **'YES'** to proceed.

If you do not wish to carry out a system reset, highlight **'NO'** and then press the **Select** button. The display will revert to the previous menu.

4. With **'YES'** highlighted, press the **Select** button. A full reset will be performed and the radio will restart as if first plugged in. The DAB stations list together with any preset stations will be erased and your wireless network connection details will be lost. All configuration settings will be restored to their defaults, the clock and alarms will be reset.

In case of malfunction for any reason, reset the product as described above to resume normal operation. It may be necessary in some cases to disconnect the mains power, then reconnect power after 10 seconds.

In case of malfunction due to electrical fast transient (burst), reset the product as above (reconnection of the power source may be required) to resume normal operation.

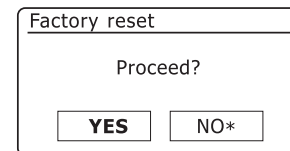
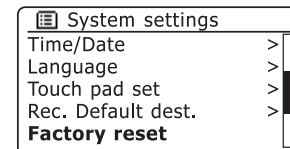
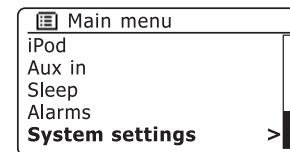
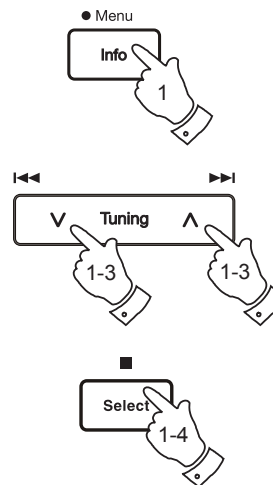

Software update

From time to time, new software features for your radio may be developed. Your radio has therefore been designed to allow its internal software to be updated using your Internet connection.

You should not attempt to update your radio unless it is recommended to you by Roberts Customer Services. Updating the software may remove all network settings, radio station presets and alarm settings from your radio.

It is important that you do not attempt this procedure unless you have a good Internet connection and a reliable mains power supply. If the radio connects to your router using a WiFi connection, make sure that this is also reliable before proceeding.

1. The '*Software update*' option is accessed via the '*System settings*' menu. When you select '*Software update*' the menu will display '*Auto check setting*' and '*Check now*'. If you want your radio to check periodically for new software versions press the **Menu Up** or **Down** buttons to highlight '*Auto check settings*'. Then press the **Select** button and select '**YES**'. If you do not want your radio to check for updates select the '**NO**' option.
2. To check if there are any software updates available currently, press the **Menu Up** or **Down** buttons to highlight '*Check now*' and then press the **Select** button. The radio will check to see if an update is available. The display will show '*Checking for new versions*'. If there are no updates then the display will show '*Software up to date*'. If a software update is available your radio will then offer the choice of updating the software or not, displaying '*New version available. Update software?*'. Select the '**YES**' option if you wish to go through the update process.
3. If you choose to update your radio it will first download the new software and will then reprogram its internal memory. This may take a few minutes depending on the speed of your internet connection.
4. Once the software update is completed, the radio will prompt you to press **Select** to restart. Press the **Select** button and your radio will then restart. You may find that you will need to reconfigure your network connection following an update. You may also need to re-enter all radio station presets, alarm settings, and configuration options.

VERY IMPORTANT: Do not switch off the power to the radio until the update operation is complete and the radio has restarted, otherwise the unit may become permanently damaged.

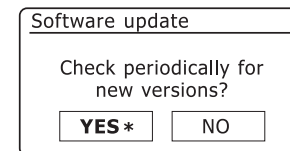
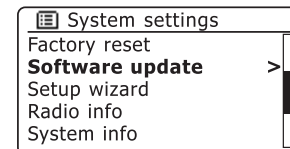
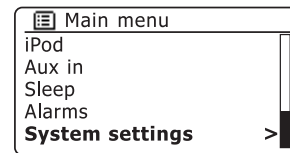

Network profiles

Each time that you connect your radio to a WiFi network, the radio will store the details of that connection (SSID, security key, DHCP/IP address settings) as a profile. Up to four such profiles are stored in the radio so that if the unit is used in multiple locations there is no need to enter the network settings when returning to a location previously visited.

The radios stores the four most recent profiles in memory identified by their SSID. Normally the radio will attempt to connect to one of the stored profiles and only if it is unable to do so will you need to use the Network Wizard (see page 18).

In the event that you visit a location only once you may wish to delete the profile for the network in that location to avoid losing other profiles.

1. Access the menu for the current mode by **pressing and holding** the **Menu** button. Press the **Menu Up** or **Down** buttons until 'System settings' is highlighted on the display. Press the **Select** button to enter the settings menu.
2. Press the **Menu Up** or **Down** buttons until 'Network' is highlighted on the display. Press the **Select** button to enter the **Network settings** menu.
3. Press the **Menu Up** or **Down** buttons until 'Network profile' is highlighted on the display. Press the **Select** button to see the stored profiles. The profile which is currently in use (if any) is marked with an asterisk.
4. To remove a profile from memory, press the **Menu Up** or **Down** buttons to highlight the profile to be deleted and then press the **Select** button.
5. The radio will offer a 'YES' or 'NO' selection. Press the **Menu Up** or **Down** buttons to select 'YES' and then press the **Select** button. The selected profile will be deleted.

Note: that it is not possible to delete a profile which is currently in use.

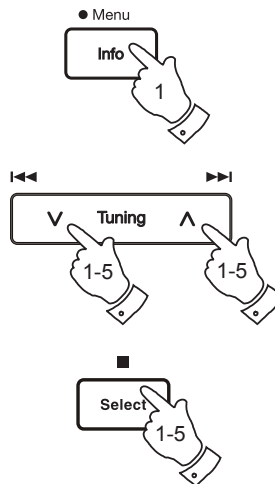

Information

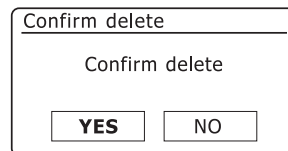
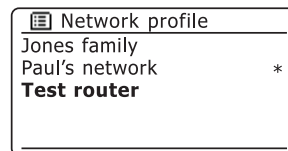
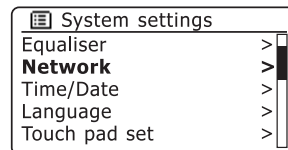
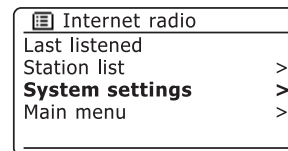

Software version display

The software version display is provided for reference and customer support purposes and cannot be changed.

1. Access the menu for the current mode by **pressing and holding** the **Menu** button. Press the **Menu Up** or **Down** buttons until 'System settings' is highlighted on the display. Press the **Select** button to enter the **System settings** menu.
2. Press the **Menu Up** or **Down** buttons until 'Radio Info' is highlighted on the display. Press the **Select** button to display the software version and radio ID.
Follow steps 1 and 2 above to view 'System info' for your radio.

3. **Press and hold** the **Menu** button to exit.

Audio FAQ

Your radio can access some audio help for Internet Radio use.

1. With your radio switched on and in the **Internet Radio** mode, **press and hold** the **Menu** button. Press the **Menu Up** or **Down** buttons until 'Station list' is highlighted on the display. Press the **Select** button.
2. Press the **Menu Up** or **Down** buttons until 'Help' is highlighted on the display. Press the **Select** button to enter the Help menu.
3. Press the **Menu Up** or **Down** buttons until 'FAQ' is highlighted. Press the **Select** button to display some frequently asked questions.
4. Press the **Menu Up** or **Down** buttons to choose a question that suits your requirements and press the **Select** button to listen to the answer.
Adjust the volume as needed.

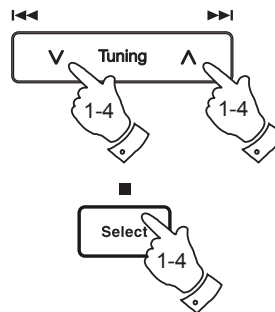
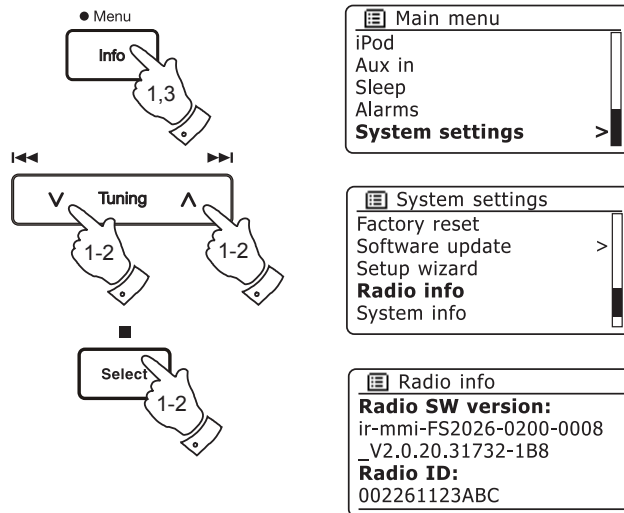

Troubleshooting

If you experience any trouble with your radio, then you may find it useful to visit the help section on our web site.

If you have difficulty connecting the radio to your computer network, some of these steps may help to resolve the problem:

1. Confirm that a WiFi connected PC can access the Internet (i.e. can browse the web) using the same network.
2. Check that a DHCP server is available (normally a router function). Your radio will by default use DHCP unless you choose to disable it. This may be configured using the menu items *'Main Menu' -> 'System settings' -> 'Network' -> 'Manual settings'*. This will ask first whether you wish to configure a wired or a wireless connection. For either wired or wireless you then need to choose *'DHCP enable'* or *'DHCP disable'*. If you enable DHCP then the radio will negotiate with your router (or DHCP server) and will be provided with an IP address as well as the other settings needed. If you wish to set the network configuration manually, refer to paragraph 6.
3. Check that your network's firewall is not blocking any outgoing ports. As a minimum, the radio needs access to UDP and TCP ports 80 and 123. Port 53 may be required for DNS. Some Internet radio services may require additional ports to be open. Windows Media Player 11 and 12 will allocate a port number for UPnP media sharing and will configure Microsoft's Windows built-in firewall appropriately. Other firewall software may require configuration for UPnP or to allow particular IP addresses to have trusted access.
4. Check that your access point does not restrict connections to particular MAC addresses (sometimes called MAC address filtering).

You can view the radio's MAC address using the menu items *'Main Menu' -> 'System settings' -> 'Network' -> 'View settings' -> 'MAC address'*.

The MAC address will typically be of the form

00 : 22 : 61 : xx : xx : xx

5. If you have an encrypted network, check that you have entered the correct encryption key into the radio. Remember that text-format WPA keys are case sensitive. If your radio displays *'Network error'* when attempting to connect to an encrypted network, then please ensure that you enter the correct key for the network. If the problem persists, then you may need to re-check your network configuration.
6. If you need to set up your radio's IP address manually, you will need to know low-level details of your network's configuration. Use the menu items *'Main Menu' -> 'System settings' -> 'Network' -> 'Manual settings' -> 'Wired'* or *'Wireless'* (as needed) -> *'DHCP disable'*.

The radio will then prompt you in turn for the

Ethernet IP address

Ethernet Subnet mask

Ethernet Gateway address

Ethernet Primary DNS

Ethernet Secondary DNS

If you are setting up a wireless connection manually you will also need to enter the SSID, the encryption type, and the encryption key.

See page 19 for full details on how to set up your radio's network configuration manually.

Troubleshooting - cont.

If your radio can connect to the network, but is unable to play a particular internet radio station, it may be due to one these causes:

1. The station is not broadcasting at this time of the day.
2. The station has reached its maximum allowed number of simultaneous connections.
3. The Internet connection between your radio and the server (often located in a different country) is slow. This could be due to internet congestion, either locally or at a distance.
4. The station may choose to block internet connections to your geographic region (sometimes known as geo-locking).
5. The station is no longer broadcasting. The database of radio stations that your radio connects to is frequently updated and checked but may not always be completely accurate.
6. The radio station is broadcasting using an audio format which is not playable by your radio (although the Stream 64i does play the most popular formats used by regular broadcasters).

Try using a PC to listen via the broadcaster's web site or via the radio station database web site at <http://www.wifiradio-frontier.com>. If you can play the station with a PC, it may be that the internet feed or local network connection is poor. However, some broadcasters (such as the BBC) provide different data streams for PC users and internet radio listeners, so this test is not always conclusive.

If you cannot play the station via your PC this may indicate that the problem is not necessarily due to your radio, but it could be your network, your internet connection, the broadcaster, or internet congestion.

Music Player / UPnP problems

The use of the Music Player function with UPnP should be straightforward. However, the cleverness of UPnP means that it is often disabled by default by security applications and in routers.

If you are using Windows Media Player as your UPnP server, and if it fails to operate with your radio, please keep this fact in mind: *A fresh installation of Windows and Windows Media Player when using Microsoft's built-in firewall software will normally work.*

If it does not work, possible reasons may include:

- UPnP functions blocked in firewall software
- UPnP functions turned off by security software
- UPnP functions 'hi-jacked' by other software
- UPnP functions blocked in the router
- Multi-cast packets blocked in the router
- IP address of system blocked in firewall software

Some third-party UPnP servers are much less dependent upon other parts of Windows than WMP 11 and 12. If the greater flexibility that these offer is attractive, then it may be found in some cases that they are easier to get working.

Accessing your audio files via a UPnP server using Windows Vista and XP

If your computer is running Windows Vista or XP, then Windows Media Player version 11 includes a UPnP server which will make your files available to your radio. There are other UPnP server solutions available for non-Windows users and for Windows users who may wish to use an alternative (see the preceding page).

It is beyond the scope of this instruction book to cover all possible options for UPnP. We explain the use of Microsoft's Windows Media Player here since that will be the first choice for the majority of users.

Set up UPnP access on a Windows PC

1. If your PC is running Microsoft Windows Vista or Windows XP then you can use Microsoft's Windows Media Player version 11 to act as your UPnP (Universal Plug and Play) media server. If not already installed on your PC, Windows Media Player 11 may be downloaded from Microsoft's web site and installed by following the instructions detailed in its installation wizard, or by using Microsoft's Windows Update facility.
2. Once installed, Windows Media Player 11 can create a library from all the media files available to it on your PC. To add new media files to the library, select the 'Library' tab, then 'Add to Library... > Advanced Options', click 'Add', choose the files you wish to add and click 'OK'.

The next step is to connect your radio to Windows Media Player 11 and to configure the program to allow the radio to access your media library.

3. Press the **On/Standby** button to switch the unit on. Then press the **Media** button as needed until the *Music Player* mode display is shown. The main '*Music Player*' menu will then be displayed.

Selecting Media Sharing in Windows Media Player 11

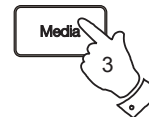
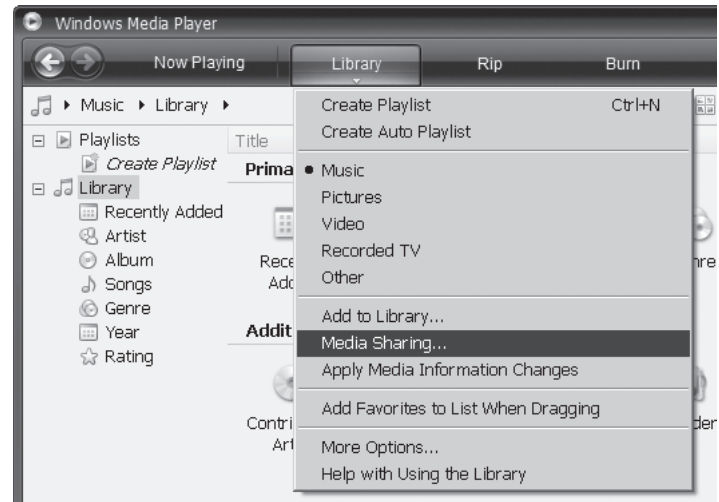

Set up UPnP access on a Windows PC - cont.

4. Press the **Menu Up** or **Down** buttons until '*Shared media*' is highlighted and press the **Select** button. The radio will scan for all available UPnP servers. It may take a few seconds for the radio to complete its scan. The radio will display '<Empty>' if no UPnP servers are found.
5. After scanning, select your UPnP server using the **Menu Up** or **Down** buttons. If you are using WMP 11 as the server, your radio will then normally display '*Unauthorised - Select to retry*' at this stage.
6. Your PC may prompt you that there has been a connection to your UPnP server. Whether prompted or not, in order that the radio may access the music files, you will need to click the '*Library*' tab in WMP 11 and select the '*Media Sharing...*' item to open the '*Media Sharing*' window. Make sure the box '*Share my media to:*' is ticked.
7. In the '*Media Sharing*' window, the radio will be listed as an unknown device. Click on the unknown device shown to select it, then click the '*Allow*' button and then click '*OK*'.

Note: If you are using Microsoft Windows' firewall software, this should be correctly configured by WMP 11. If you are using third party firewall software you may need to manually configure it to allow your unit and WMP 11 to communicate (see the 'Troubleshooting' section on page 104).

8. On the radio, select the named server again using the **Menu Up** or **Down** and **Select** buttons. If WMP 11 is now able to communicate with your radio you will be presented with some media selection options on the display.

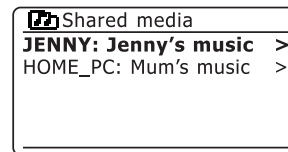
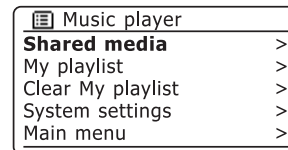
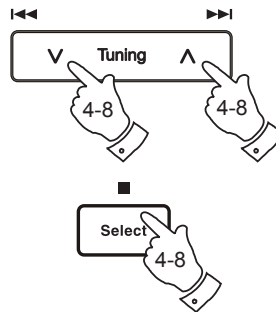

Allowing a device to connect to Windows Media Player 11

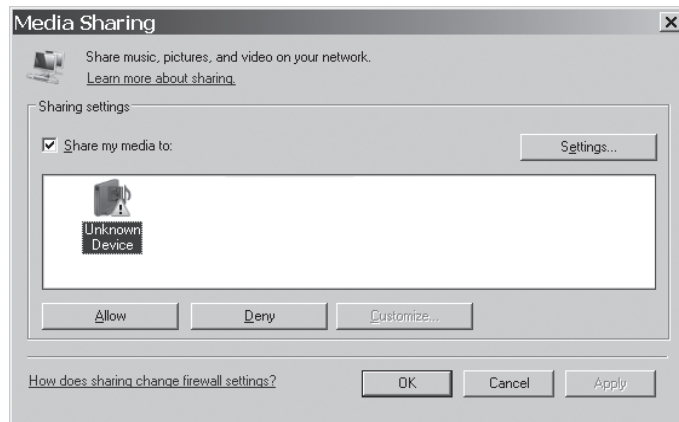

Audio codecs

Your radio supports a range of audio codecs which provide compatibility with a wide range of Internet Radio stations. These also allow users to stream music from their computers or to play directly from USB and SD/SDHC flash memory devices.

Note that for any given audio codec, there are many streaming protocols available, and thus even if an Internet Radio station uses a supported format, this does not guarantee that every such station will work with your radio. The radio stations database to which your radio connects is checked for compatibility so that most stations should be playable without problems. Similarly when streaming media from a computer, while a codec may be supported, there can be many subtle variations in formats, tagging schemes and protocols (even within UPnP). In general your radio will play the supported formats with most common UPnP servers.

Bit-Rates

The following table summarises the maximum supported bit-rates for the various audio formats that are playable on your radio. Higher rates may be playable in some cases but performance of the product may be affected.

Codec	Maximum supported rate
AAC (LC)	320 kbits/sec
FLAC ⁽¹⁾	1.5 Mbits/sec
LPCM ⁽²⁾	1.536 Mbits/sec
MP3	320 kbits/sec
Real Audio	64 kbits/sec
WAV	1.536 Mbits/sec
WMA ⁽³⁾	320 kbits/sec

All codecs support 2-channel (stereo) coded files only.

All codecs support sample rates up to 48 kbits/sec (includes 32 and 44.1 kbits/sec).

USB and SD/SDHC playback supports MP3 and WMA formats only.

Files which have Digital Rights Management (DRM) protection applied will not be playable on your radio.

(1) 16 and 24 bit samples are supported in FLAC files

(2) The maximum supported bit-rate is for a 48 kHz sampling, 2 channels and 16-bits per sample.

(3) WMA Lossless, WMA Voice, WMA 10 Professional, and files which have DRM protection are not supported.

Cautions

Do not allow your radio to be exposed to water, steam or sand.

Do not leave your radio where excessive heat could cause damage.

The name plate is located on the rear of the radio.



- The radio shall not be exposed to dripping or splashing and no objects filled with liquids, such as vases, shall be placed on the radio.
- It is recommended to operate the product such that there is a minimum distance (10cm recommended) to adjacent objects in order to ensure good ventilation.
- The ventilation of the product should not be restricted by covering it with items such as newspapers, tablecloths, curtains etc.
- No naked flame sources such as lighted candles should be placed on the product.
- It is recommended to avoid using or storing the product at extremes of temperature. Avoid leaving the unit in cars, on window sills, in direct sunlight etc.
- The radio must be used in a moderate climate.

Specifications

Power Requirements

Mains AC 230 volts, 50Hz  only

Remote Control Battery 2 x AAA

Frequency Coverage

FM 87.5 - 108 MHz

DAB 174.928 - 239.200 MHz

Connectivity

Wired Ethernet 10/100M bits/sec via RJ-45 socket

WiFi 802.11b and 802.11g supported with WEP and WPA/WPA2 encryption
Compatible with 802.11n routers which offer mixed mode support for 802.11b/g

Circuit features

Loudspeaker 2 x 77 mm

Output Power 12 Watts x 2 (peak)
6 Watts x 2 (continuous)

Headphone socket 3.5mm diameter, stereo

Aux In socket 3.5mm diameter, stereo

Line out socket 3.5mm diameter, stereo

Digital optical output socket Toslink

Aerial System
WiFi WiFi antenna
DAB Telescopic aerial
FM Telescopic aerial

Information

Mains supply

The Stream 64i will operate from a supply of AC 230 volts, 50Hz  only.

DO NOT cut off the mains plug from this equipment. If the plug fitted is not suitable for the power points in your home or the cable is too short to reach a power point, then obtain an appropriate safety approved extension lead or adaptor. If in doubt consult your dealer.

If nonetheless the mains plug is cut off, remove the fuse and dispose of the plug immediately to avoid a possible shock hazard by inadvertent connection to the mains supply.

If this product is not supplied with a mains plug, or one has to be fitted, then follow the instructions given below:

IMPORTANT. DO NOT make any connection to the larger terminal which is marked with the letter E or by the safety earth symbol  or coloured Green or Green-and-yellow.

The wires in the mains lead are coloured in accordance with the following codes :-

BLUE - NEUTRAL

BROWN - LIVE

The wire coloured BLUE must be connected to the terminal marked N or coloured BLACK.

The wire coloured BROWN must be connected to the terminal marked L or coloured RED.

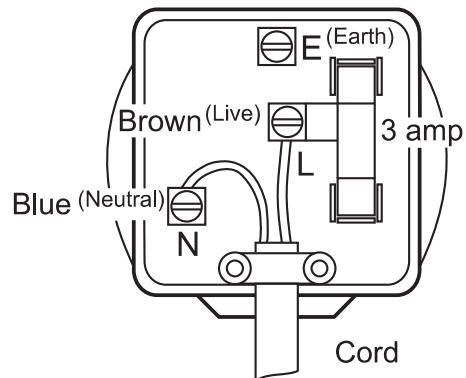

Fuse

When replacing the fuse only a 3A AASTA approved to BS1362 type should be used and be sure to re-fit the fuse cover.

IF IN DOUBT - CONSULT A QUALIFIED ELECTRICIAN.

Replacement fuse holders are available from Roberts Radio Technical Services at the address shown on the rear of this manual.

Software license information

Use of the software in this radio is subject to software licence terms contained in this user manual - by using radio, you are agreeing to comply with these licence terms:

MPEG Layer-3 audio coding technology licensed from Fraunhofer IIS and Thomson.

MPEG-4 HE-AAC audio coding technology licensed by Fraunhofer IIS.

<http://www.iis.fraunhofer.de/amm/>



RealNetworks is a trademark or a registered trademark of RealNetworks, Inc.

Portions of this software are included under license from RealNetworks, Inc. Copyright 1995 to 2007, RealNetworks, Inc. All rights reserved.

This product is protected by certain intellectual property rights of Microsoft. Use or distribution of such technology outside of this product is prohibited without a license from Microsoft.

If you download a software upgrade to your radio, additional licence terms may apply and these are available at:

<http://www.frontier-silicon.com/audio/eula.htm>

This product is guaranteed for twelve months from the date of purchase by the original owner against failure due to faulty workmanship or component breakdown, subject to the procedure stated below. Should any component or part fail during this guarantee period it will be repaired or replaced free of charge.

The guarantee does not cover:

1. Damage resulting from incorrect use.
2. Consequential damage.
3. Product with removed or defaced serial numbers.

N.B. Damaged or broken aerials will not be replaced under guarantee.

Procedure:

Any claim under this guarantee should be made through the dealer from whom the product was purchased. It is likely that your Roberts' dealer will be able to attend to any defect quickly and efficiently, but should it be necessary the dealer will return the product to the company's service department for attention. In the event that it is not possible to return the product to the Roberts' dealer from whom it was purchased, please contact Roberts Radio Technical Services at the address shown on the rear of this manual.

These statements do not affect the statutory rights of a consumer.

ROBERTS RADIO TECHNICAL SERVICES

97-99 Worton Road
Isleworth
Middlesex
TW7 6EG

Technical Helpline :- 020 8758 0338 (Mon-Fri during office hours)

Web site: <http://www.robertsradio.co.uk>



Issue 1

© 2014 Roberts Radio Limited

