

# ***SportsDAB 4***

DAB/FM personal digital radio with OLED display

# ROBERTS

Enjoy Listening



Please read this manual before use

**DAB**  
Digital Audio Broadcasting

**DAB+**

**+** Digital  
Radio

# Contents

|   |       |
|---|-------|
| <i>Controls</i> .....                             | 3-4   |
| <i>Using the AC adaptor</i> .....                 | 5-6   |
| <i>Keylock function</i> .....                     | 7-8   |
| <i>Navigation</i> .....                           | 9-10  |
| <i>Display icons</i> .....                        | 11-12 |
| <i>Earphones</i> .....                            | 13-14 |
| <i>Operating your radio - DAB</i> .....           | 15-16 |
| <i>Selecting a station - DAB</i> .....            | 17-18 |
| <i>Display options - DAB</i> .....                | 19-22 |
| <i>Signal strength display - DAB</i> .....        | 23-24 |
| <i>Finding new stations - DAB</i> .....           | 25-26 |
| <i>Secondary services - DAB</i> .....             | 27-28 |
| <i>Manual tuning - DAB</i> .....                  | 29-30 |
| <i>Dynamic range control settings - DAB</i> ..... | 31-32 |
| <i>Station order setup - DAB</i> .....            | 33-34 |

|  |              |
|--|--------------|
| <i>Operating your radio - Search tuning - FM....</i> | <i>35-36</i> |
| <i>Manual tuning - FM.....</i>                       | <i>37-38</i> |
| <i>Display options - FM.....</i>                     | <i>39-40</i> |
| <i>FM stereo/mono .....</i>                          | <i>41-42</i> |
| <i>Scan sensitivity setting - FM.....</i>            | <i>43-44</i> |
| <i>Preset stations DAB and FM .....</i>              | <i>45-48</i> |
| <i>Sleep function.....</i>                           | <i>49-50</i> |
| <i>Contrast.....</i>                                 | <i>51-52</i> |
| <i>Software version.....</i>                         | <i>53-54</i> |
| <i>Screen TimeOut function.....</i>                  | <i>55-56</i> |
| <i>System reset.....</i>                             | <i>57-58</i> |
| <i>General.....</i>                                  | <i>59-60</i> |
| <i>Specifications .....</i>                          | <i>61</i>    |
| <i>Circuit features .....</i>                        | <i>61</i>    |
| <i>Guarantee.....</i>                                | <i>62</i>    |

## Controls

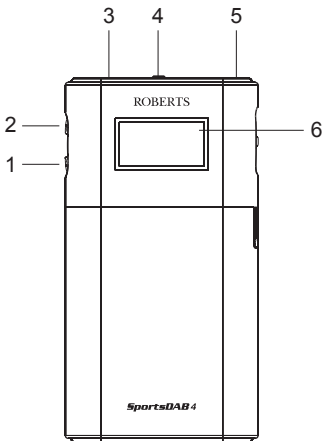

- |                       |                    |
|-----------------------|--------------------|
| 1. Volume Down button | 4. Lock switch     |
| 2. Volume Up button   | 5. On / Off button |
| 3. Earphone socket    | 6. OLED display    |

## Controls

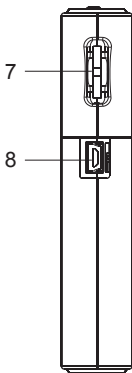

7. Jog wheel

8. Charging socket

*If you need any further advice, please call our Technical Helpline on :- 020 8758 0338 (Mon-Fri)*

## Using the AC adaptor

The **SportsDAB4** features a built-in 1180mAH rechargeable Lithium battery to power your radio. Before operating the radio for the first time, ensure that you fully charge the radio.

1. Place your radio on a flat surface. Carefully pull back the protection cover and insert the adaptor plug into the charging socket on the right hand side of your radio.
2. Plug the adaptor into a standard 13A mains socket outlet. If the radio is switched on the battery indicator will become animated showing charging in progress. **Note:** If charging the radio when the radio is switched off, the battery power icon will not show on the display.
3. The radio will begin charging the built-in battery. Charging time will take 3 hours with the radio switched off and 6 hours if the radio is switched on.
4. The battery power icon will flash whilst charging and stop flashing when the radio is fully charged. Reduced power, distortion, 'stuttering' sounds or the battery power indicator low are all signs that the battery needs to be recharged.

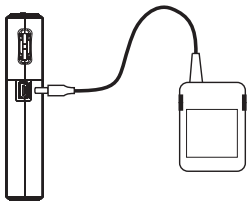

*The AC adaptor should be disconnected from the mains supply and the radio when not in use.*

**IMPORTANT:** The mains adaptor is used as the means of connecting the radio to the mains supply. The mains socket used for the radio must remain accessible during normal use. In order to disconnect the radio from the mains completely, the mains adaptor should be removed from the mains socket outlet completely.

**Note:** The mains adaptor which is supplied with your radio is a high efficiency type, designed to minimise energy consumption, whether the radio is playing, charging its battery or switched off. Do not use any other mains adaptor in place of the unit supplied. Such use will invalidate your guarantee.

## Keylock function

The **Keylock function** is used to prevent unintentional operation of your radio.

1. Set the **Lock** switch located on the top of your radio to the '**Lock**' position. The On/Off and all other buttons will be disabled. This will prevent accidental operation when your radio is packed in a suitcase or travel bag. The lock indicator '' will show on the display.
2. To release the **Lock** switch, move the lock switch to the '**Unlock**' position.



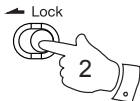
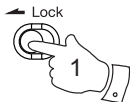
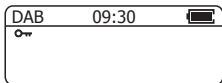

*If you need any further advice, please call our Technical Helpline on :- 020 8758 0338 (Mon-Fri)*

## Navigation

This page describes the basic means of controlling your **Sports DAB 4**. Instructions for each operating mode are given in the later sections of this book.

1. Press and hold in the ***Jog wheel*** to access the main menus.
2. Many operations require the user to make a selection from the menus. Push the ***Jog wheel*** Up or Down to highlight the desired menu item and then click the ***Jog wheel*** to select that item. A scroll bar is used to show that there are more items in that menu.
3. If an error is made or you wish to go to the previous screen there is a '***Back***' menu item in most menus. Push the ***Jog wheel*** Up or Down until '***Back***' is highlighted on the display and click the ***Jog wheel*** to select. After a period of inactivity the display will revert to the previous information display.

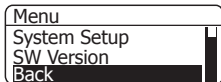

4. After a period of inactivity the display will turn off in order to conserve battery power but the radio will continue playing. This period of time is adjustable, please see 'Screen TimeOut function' page 55.

## Display icons

- a. Key lock indicator
- b. Mode indicator
- c. Preset number indicator
- d. Time (24 hour format)
- e. Sleep indicator
- f. Battery / Charge indicator
- g. Signal strength indicator

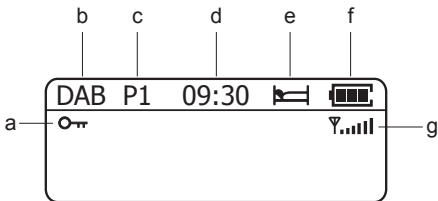

*If you need any further advice, please call our Technical Helpline on :- 020 8758 0338 (Mon-Fri)*

## Earphones

The lead connecting the earphones to your radio acts as an aerial when plugged into the **Earphone** socket. The lead should be extended as much as possible to increase reception.

1. Plug the earphones into the **Earphone** socket on the top of your radio.
2. Check that the **Volume level** is not too loud before placing the ear-pieces into your ears.

**IMPORTANT:** Do not switch on the radio with the earphones connected and inserted in your ear. Excessive sound pressure from earphones can cause hearing loss.

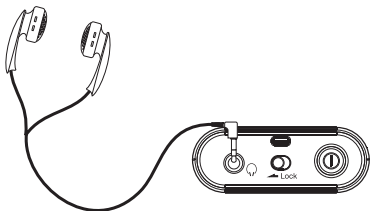

*If you need any further advice, please call our Technical Helpline on :- 020 8758 0338 (Mon-Fri)*

## Operating your radio - DAB

1. Carefully extend the earphone antenna.
2. Press the **On/Off** button to switch on your radio. The display will show '*Welcome to Digital Radio*'.
3. If this is the first time the radio is used a scan of the Band III DAB channels will be carried out. If the radio has been used before the last used station will be selected.
4. During the scanning process, the lower line of the display shows a bar-graph indicating progress of the scan.
5. When the scanning is completed the first station (in numeric-alpha order 0...9...A....Z) will be selected. Your radio will automatically set to the current time.
6. If the station list is still empty after the scan your radio will display '*No Service*'.
7. If no signals are found it may be necessary to relocate your radio to a position giving better reception. Then, either switch your radio off and on again, or follow the procedure page 25 to repeat the scan.





Welcome to  
Digital Radio

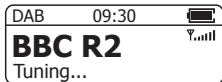
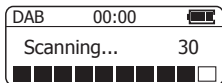

*If you need any further advice, please call our Technical  
Helpline on :- 020 8758 0338 (Mon-Fri)*

## Selecting a station - DAB

**Note:** If you need to select the DAB mode, press and hold the **Jog wheel** and highlight '*DAB Band*' and click the **Jog wheel** to select.

1. With your radio in DAB mode, push the **Jog wheel** either up or down to scroll through the list of available stations. Stop when you find the station that you wish to hear.
2. Click the **Jog wheel** to select the station. The display may show '*Tuning...*' while your radio finds the new station.
3. Adjust the **Volume** to the required setting.

**Note:** If after selecting a station the display shows '*Signal n/a*' it may be necessary to relocate your radio to a position giving better reception.

The use of radio station presets for selecting your preferred radio stations is described on page 45.

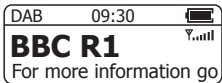
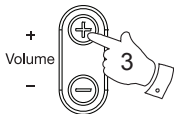
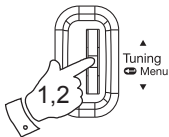

*If you need any further advice, please call our Technical Helpline on :- 020 8758 0338 (Mon-Fri)*

## Display options - DAB

When in DAB mode your radio has a range of display options:-

1. Click the **Jog wheel** to cycle through the various options.
  - a. Scrolling text                      Displays scrolling text messages such as artist /track name, phone in number etc.
  - b. Program Type                        Displays the type of station being listened to e.g. Pop, Classic, News etc.
  - c. Multiplex Name                      Displays the name of DAB multiplex to which the current station belongs.
  - d. Date                                    Displays the current date.



a



b



c



d



If you need any further advice, please call our Technical Helpline on :- 020 8758 0338 (Mon-Fri)

## Display options - DAB cont.

- |                          |  |
|--------------------------|--|
| e. Channel & frequency   | Displays the channel number and frequency of the DAB multiplex for the station listened to.  |
| f. Bit rate & audio type | Displays the digital bit rate & audio type for the station being listened to.  |
| g. Signal strength       | Displays signal strength for the tuned DAB station. The open block in the signal strength graph shows minimum signal strength needed for good DAB reception. |

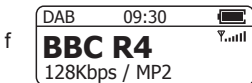
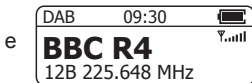

## Signal strength display - DAB

1. Position your radio and try moving the earphone antenna so as to give the maximum signal strength. Normally, the best reception will be found with the earphone antenna fully extended.
2. The signal strength indicator  in the top right hand corner of the display will go up and down according to the signal being received.





*If you need any further advice, please call our Technical Helpline on :- 020 8758 0338 (Mon-Fri)*

## Finding new radio stations - DAB

As time passes new stations may become available. To find new stations proceed as follows:-

1. Ensure your radio is in DAB mode. Press and hold the ***Jog wheel***.
2. Push the ***Jog wheel*** up or down until '***Full Scan***' is highlighted on the display.
3. Click the ***Jog wheel***. The display will show '***Scanning...***' and your radio will perform a scan of the Band III DAB channels. As new radio stations are found the station counter on the right-hand side of the display will increase and the radio stations will be added to the list stored in the radio.

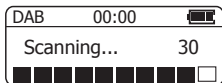
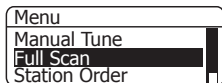
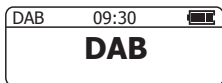
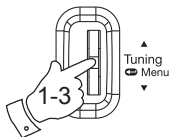

*If you need any further advice, please call our Technical Helpline on :- 020 8758 0338 (Mon-Fri)*

## Secondary services - DAB

1. Certain radio stations have one or more secondary services associated with them. The secondary service will then appear immediately after the primary service as you push the **Jog wheel** down.
2. Click the **Jog wheel** to select the station.
3. When the secondary service shuts down, your radio will automatically switch back to the main radio station (or primary service) if it is available.

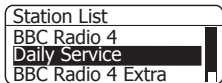
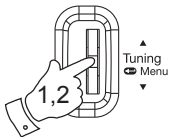

*If you need any further advice, please call our Technical Helpline on :- 020 8758 0338 (Mon-Fri)*

## Manual Tuning - DAB

Manual tuning allows you to tune directly to the various DAB Band III channels. UK DAB stations located in the range 11B to 12D.

1. Press and hold in the **Jog wheel**.
2. Push the **Jog wheel** up or down until 'Manual Tune' is highlighted. Click the **Jog wheel** to select this function.
3. Push the **Jog wheel** up or down to highlight the desired channel.
4. Click the **Jog wheel**. The open block in the signal strength graph shows the minimum signal strength needed for good DAB reception. The signal blocks will go up and down showing the changing signal strength as you adjust the earphone antenna or the radio position. Any stations found will be added to the stored list in the radio.
5. Click the **Jog wheel** to return to the normal tuning mode.

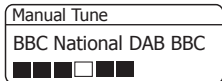
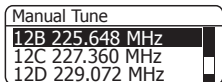
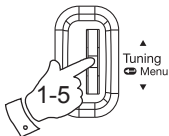

If you need any further advice, please call our Technical Helpline on :- 020 8758 0338 (Mon-Fri)

## Dynamic Range Control settings - DAB

Dynamic Range Control (also known as DRC) can make quieter sounds easier to hear when your radio is used in a noisy environment.

1. When in DAB mode, press and hold in the **Jog wheel**.
2. Push the **Jog wheel** up or down until 'DRC Value' is highlighted on the display. Click the **Jog wheel** to enter the DRC settings menu.
3. Push the **Jog wheel** up or down to select the required DRC setting (the default is 0).

DRC 0 - DRC is switched off, Broadcast DRC will be ignored. DRC 1/2 - DRC level is set to 1/2 that sent by broadcaster. DRC 1 - DRC level is used as sent by broadcaster. The current DRC setting will be marked with an asterisk.

4. Click the **Jog wheel** to confirm the setting. The display will return to the previous display.

**Note:** Not all DAB broadcasts are able to use the DRC function. If the broadcast does not support DRC, then the DRC setting in the radio will have no effect.



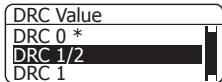
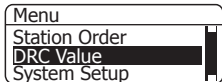
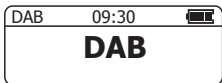

## Station order setup - DAB

Your radio has 3 station order settings from which you can choose. The station order settings are alphanumeric, ensemble and valid. **Note:** The default station order on your radio is alphanumeric.

1. When in DAB mode, press and hold in the **Jog wheel**.
2. Push the **Jog wheel** up or down until 'Station Order' is highlighted on the display. Click the **Jog wheel** to enter the station order settings menu.
3. Push the **Jog wheel** up or down to choose between 'Alphanumeric', 'Ensemble' and 'Valid'.

'Alphanumeric' - sorts the station list alpha-numerically 0...9, A...Z. 'Ensemble' - organises the station list by DAB multiplex. 'Valid' - shows only those stations for which a signal can be found.

The current setting will be marked with an asterisk.

4. Click the **Jog wheel** to confirm the setting. The display will return to the previous display.

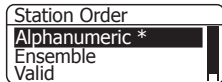
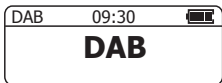

*If you need any further advice, please call our Technical Helpline on :- 020 8758 0338 (Mon-Fri)*

## Operating your radio - Search tuning - FM

1. Carefully extend the earphone antenna fully and press the **On/Off** button to switch on your radio.
2. To select the FM mode, press and hold the **Jog wheel** 'FM Band' will be highlighted on the display. Click the **Jog wheel**.
3. Push the **Jog wheel** up and hold for 2 seconds, your radio will scan in an upwards direction (low frequency to high frequency) and stop automatically when it finds a station of sufficient strength.
4. After a few seconds the display will update. The display will show the frequency of the signal found. If the signal is strong enough and there is RDS data present then the radio may display the station name.
5. To find other stations, push the **Jog wheel** up and hold as before.
6. To scan the FM band in a downwards direction (high frequency to low frequency) push the **Jog wheel** down and hold for 2 seconds.

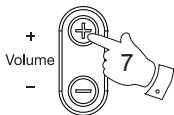
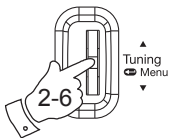

7. When the waveband end is reached your radio will recommence tuning from the opposite waveband end. Adjust the **Volume** to the required setting.

The use of radio station presets for selecting your preferred radio stations is described on page 45.

## Manual tuning - FM

1. Carefully extend the earphone antenna fully for FM reception. Press the **On/Off** button to switch on your radio.
2. Select the FM mode as previously described if required.
3. Push the **Jog wheel** up or down to tune to a station. With each push of the **Jog wheel** the frequency will change up or down by 50 kHz.
4. When the waveband end is reached the radio will recommence tuning from the opposite waveband end.
5. Set the **Volume** to the desired settings.
6. To switch off your radio press the **On/Off** button.

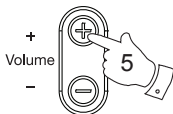
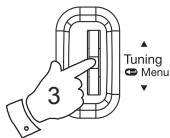

*If you need any further advice, please call our Technical Helpline on :- 020 8758 0338 (Mon-Fri)*

## Display options - FM

When in FM mode your radio has a range of display options:-

1. Click the ***Jog wheel*** to cycle through each of the options.
  - a. Scrolling text      Displays scrolling text such as artist name, phone in number, etc.
  - b. Program type      Displays type of station being listened to e.g. Pop, Classic, News, etc.
  - c. Date      Displays the current date.
  - d. Frequency      Displays the FM frequency.
  - e. Audio mode      Display shows stereo or Mono.

**Note:** Your radio will display '*Radio Text*' on the lower line of the display if there is no scrolling text available and '*Program Type*' if there is no programme type information.



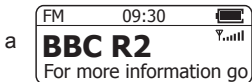

If you need any further advice, please call our Technical Helpline on :- 020 8758 0338 (Mon-Fri)

## FM Stereo/Mono

If a station being received is weak some hiss may be audible.

1. When in FM mode, to reduce the hiss press and hold the ***Jog wheel***.
2. Push the ***Jog wheel*** up or down until 'FM Audio' is highlighted on the display. Click the ***Jog wheel***.
3. Push the ***Jog wheel*** up or down until 'Mono' is highlighted on the display. Click the ***Jog wheel*** to select Mono. Your radio will select the mono audio mode.
4. To return to stereo mode, follow steps 1 and 2 above.
5. Push the ***Jog wheel*** up or down until 'Auto' is highlighted on the display. Click the ***Jog wheel***. Your radio will switch to stereo mode. The chosen setting will be marked with an asterisk.

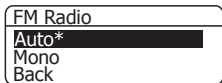
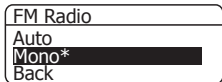
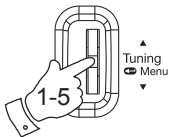

## Scan sensitivity setting - FM

Your radio includes a local/distant option for the Auto-scan function. By setting the radio to the 'local' scan option, weaker signals from more distant transmitters can be ignored by the radio, making stronger signals easier to find.

1. When in FM mode, press and hold in the **Jog wheel**.
2. Push the **Jog wheel** up or down until 'FM Scan Zone' is highlighted on the display. Click the **Jog wheel** to enter the scan sensitivity menu.
3. Push the **Jog wheel** up or down to switch between 'Local' (Strong stations only) and 'Distant' (All stations) options. The Distant option will allow the radio to find weaker signals when scanning.
4. Click the **Jog wheel** to confirm the setting. The Local or Distant setting is stored in the radio and remains in force until changed or until a system reset.

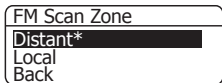
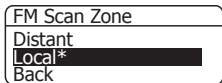

## Presetting stations

You may store your preferred DAB and FM radio stations to the preset station memories. There are 20 memory presets in your radio, 10 for DAB and 10 for FM. Presets are remembered by your radio in the event of a power failure.

The procedure for setting presets and using them to tune stations is the same for FM and DAB modes, and is described below.

1. Press the **On/Off** button to switch on the radio.
2. Select the desired waveband.
3. Tune to the required station as previously described.
4. Press and hold the **Jog wheel** to enter the menu and then push up or down until 'Favourite Station' is highlighted. Click the **Jog wheel**.
5. Push the **Jog wheel** up or down until 'Preset Station' is highlighted. Click the **Jog wheel**.
6. Push the **Jog wheel** up or down to select the desired preset number under which you wish to store the station.

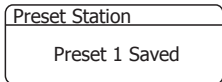
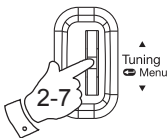

- Click the **Jog wheel**. The display shows, for example, 'Preset 1 Saved'. The station will be stored under the chosen preset. Repeat this procedure as needed.
- Stations which have been stored in preset memories may be overwritten by following the above procedure.

## Recalling a preset

1. Press the **On/Off** button to switch on the radio.
2. Select the required waveband as previously described.
3. Press and hold the **Jog wheel** to enter the menu and then push up or down until '*Favourite Station*' is highlighted. Click the **Jog wheel**.
4. Push the **Jog wheel** up or down until '*Recall Station*' is highlighted. Click the **Jog wheel**.
5. Push the **Jog wheel** up or down to highlight the desired preset station.
6. Click the **Jog wheel** to tune to the station stored in preset memory.

**Note:** If you have not previously stored a preset station '*P1: Empty*' for example will be displayed.



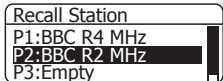
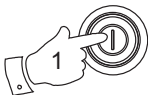

*If you need any further advice, please call our Technical Helpline on :- 020 8758 0338 (Mon-Fri)*

## Sleep function

Your radio can be set to turn off after a preset time has elapsed. The sleep setting can be adjusted between 15 and 120 minutes. Ensure your radio is switched on.

1. Press and hold the **Jog wheel** to enter the menu and then push up or down until 'System Setup' is highlighted on the display.
2. Click the **Jog wheel** and then push up or down until 'Sleep' is highlighted on the display.
3. Click the **Jog wheel** to enter adjustment mode. The current sleep setting will be marked with an asterisk.
4. Push the **Jog wheel** up or down to set the desired sleep time between 15 and 120 minutes or Off which will cancel the sleep function.
5. Click the **Jog wheel** to confirm the setting. The sleep timer indicator  will show on the display. Your radio will switch off after the preset sleep time has elapsed.
6. To cancel the sleep timer and switch off your radio before the chosen sleep time has elapsed, press the **On/Off** button.

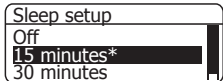
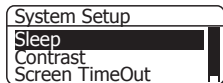
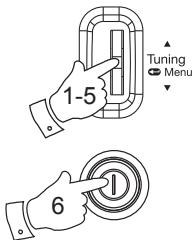

To cancel the sleep timer without switching off your radio, set the desired sleep time to 'Off'.

## Contrast

The contrast of the display can be adjusted on your radio.

1. To adjust the contrast press and hold the **Jog wheel** to enter the menu and then push up or down until 'System Setup' is highlighted on the display.
2. Click the **Jog wheel** and then push up or down until 'Contrast' is highlighted on the display.
3. Click the **Jog wheel** to enter adjustment mode.
4. Push the **Jog wheel** up or down to adjust the contrast level (between 1 and 10). The contrast level indication on the screen will change at the same time. When you find the setting that gives you the best legibility for the location in which the radio is used, click the **Jog wheel** to save the setting.

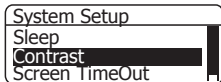

## Software version

The software display cannot be altered and is just for your reference.

1. To view the software version press and hold the ***Jog wheel*** to enter the menu.
2. Push the ***Jog wheel*** up or down until 'SW Version' is highlighted on the display.
3. Click the ***Jog wheel***. The software version will appear on the display.

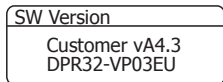
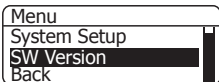
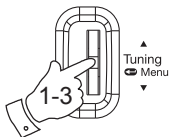

*If you need any further advice, please call our Technical Helpline on :- 020 8758 0338 (Mon-Fri)*

## Screen TimeOut function

Your radio can be set so that after a period of inactivity the display will turn off in order to conserve battery power but the radio will continue playing. This period of time is adjustable.

1. Press and hold the **Jog wheel** to enter the menu and then push up or down until 'System Setup' is highlighted on the display.
2. Click the **Jog wheel** and then push up or down until 'Screen TimeOut' is highlighted on the display.
3. Click the **Jog wheel** to enter adjustment mode. The current setting will be marked with an asterisk.
4. Push the **Jog wheel** up or down to choose the desired Screen TimeOut setting. Choose either 15, 30 or 45 seconds or to the Off setting. If Off is selected the display will remain on whilst your radio is playing. The default setting after a system reset will be Off.
5. Click the **Jog wheel** to confirm the setting.



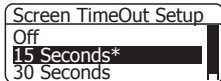
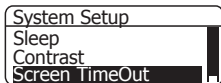

*If you need any further advice, please call our Technical Helpline on :- 020 8758 0338 (Mon-Fri)*

## System reset

If your radio fails to operate correctly, or some digits on the display are missing or incomplete carry out the following procedure.

If you have moved to a different part of the country and you wish to erase local DAB radio stations that are no longer available from the stored list, then you may carry out this procedure. Your radio will automatically re-scan for the DAB stations available at your current location when it restarts.

1. Press and hold the **Jog wheel** to enter the menu.
  2. Push the **Jog wheel** up or down until 'System Setup' is highlighted on the display. Click the **Jog wheel**.
  3. Push the **Jog wheel** up or down until 'Factory Reset' is highlighted on the display. Click the **Jog wheel**.
  4. If you wish to perform the reset operation, push the **Jog wheel** up or down until 'Yes' is highlighted on the display and click the **Jog wheel**. A full reset of your radio will be performed. All presets and station lists will be erased.
- If you do not wish to reset your radio push the **Jog wheel** up or down until 'No' is highlighted and click the **Jog wheel**. Your radio will return to the previous menu.

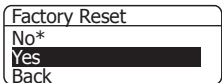
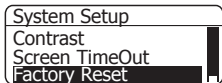

5. After a system reset a scan of the DAB band will be performed.

In case of malfunction due to electrostatic discharge, reset the product (temporary disconnection of the power adaptor may be required) to resume normal operation.

*If you need any further advice, please call our Technical Helpline on :- 020 8758 0338 (Mon-Fri)*

## General

Do not allow this radio to be exposed to water, steam or sand. Do not leave your radio where excessive heat could cause damage such as in a parked car where the heat from the sun can build up even though the outside temperature may not seem too high. It is recommended that the DAB band be used wherever possible as better results in terms of quality and freedom from interference will usually be obtained than on the FM band.

The name plate is located on the rear of your radio.



- Your radio should not be exposed to dripping or splashing and that no objects filled with liquids, such as vases, shall be placed on the radio.
- It is recommended to operate the product such that there is a minimum distance (10cm recommended) to adjacent objects in order to ensure good ventilation.
- The ventilation of the product should not be restricted by covering it or its ventilation openings with items such as newspapers, tablecloths, curtains etc.
- No naked flame sources such as lighted candles should be placed on the product.
- It is recommended to avoid using or storing the product at extremes of temperature. Avoid leaving the unit in cars, on window sills, in direct sunlight etc.

## Specifications

**Power Requirement** Mains (via adaptor)  
AC 100  $\sim$  240V 50/60Hz DC 5V 500 mA

Lithium rechargeable battery 3.7V / 1180 mAH

### **Battery life full charge**

Up to 12 hours when used for 4 hours a day at normal volume.

### **Frequency Coverage**

FM 87.5-108MHz, DAB 174.928 -239.200MHz

The Company reserves the right to amend the specification without notice.

## Circuit Features

|                 |                   |
|-----------------|-------------------|
| Output Power    | 2 x 2mW           |
| Earphone socket | 3.5mm dia. stereo |
| Aerial System   | Earphone antenna  |

## Guarantee

This instrument is guaranteed for twelve months from the date of delivery to the original owner against failure due to faulty workmanship or component breakdown, subject to the procedure stated below. Should any component or part fail during this guarantee period it will be repaired or replaced free of charge.

The guarantee does not cover: 1. Damage resulting from incorrect use. 2. Consequential damage. 3. Receivers with removed or defaced serial numbers.

Procedure: Any claim under this guarantee should be made through the dealer from whom the instrument was purchased. It is likely that your Roberts' dealer will be able to attend to any defect quickly and efficiently, but should it be necessary the dealer will return the instrument to the company's service department for attention. In the event that it is not possible to return the instrument to the Roberts' dealer from whom it was purchased, please contact Roberts Radio Technical Services at the address shown on the rear of this manual.

*These statements do not affect the statutory rights of a consumer.*

*If you need any further advice, please call our Technical Helpline on :- 020 8758 0338 (Mon-Fri)*

## ROBERTS RADIO TECHNICAL SERVICES

97-99 Worton Road

Isleworth Middlesex

TW7 6EG

Technical Helpline :- 020 8758 0338 (*Mon-Fri  
during office hours*)

<http://www.robertsradio.co.uk>

