

ROBERTS

SOUND 38

DAB / DAB+ / FM / CD Stereo Clock Radio with CD Bookmark



DAB
Digital Audio Broadcasting

DAB+

+ Digital
Radio

Please read this manual before use

Contents

<i>Sound 38 clock radio features</i>	2	<i>CD repeat function</i>	22
<i>Controls</i>	3-4	<i>CD intro function</i>	22
<i>Using your clock radio for the first time</i>	5	<i>CD random play</i>	23
<i>Operating your clock radio - DAB</i>	6	<i>Creating a play list (Program play)</i>	23
<i>Selecting a station - DAB</i>	7	<i>Checking and editing a program</i>	24
<i>Secondary services - DAB</i>	7	<i>Erasing a program</i>	24
<i>Display options - DAB</i>	8	<i>Setting alarms</i>	25-27
<i>Finding new stations - DAB</i>	9	<i>Snooze function</i>	28
<i>Signal strength display - DAB</i>	9	<i>Sleep function</i>	29
<i>Manual tuning - DAB</i>	10	<i>Clock display</i>	30
<i>Dynamic Range Control (DRC) settings - DAB</i>	11	<i>Dimmer</i>	30
<i>Operating your radio - Search tuning FM</i>	12	<i>Software version</i>	31
<i>Manual tuning - FM</i>	13	<i>USB socket for software upgrades</i>	31
<i>Display options - FM</i>	14	<i>System reset</i>	32
<i>Stereo / Mono setting - FM</i>	15	<i>Headphone socket</i>	33
<i>Presetting stations</i>	15-16	<i>Auxiliary input socket</i>	33
<i>Compact discs / MP3/WMA-CDs</i>	17-18	<i>Cautions</i>	34
<i>Playing a CD</i>	19	<i>Specifications and circuit features</i>	34
<i>CD Bookmark</i>	20	<i>Guarantee</i>	Back page
<i>Selecting a track</i>	21		
<i>Search function</i>	21		

Sound 38 clock radio features

The Roberts Sound 38 clock radio provides the following features in an attractive compact unit.

- Radio for DAB and FM with RDS broadcasts.
- Audio CD player with track search and programming facility (can also play CDR or CD-RW discs).
- Playback of MP3 and WMA files which have been recorded to CD-R, CD-RW discs.
- 20 station presets (10 for DAB and 10 for FM).
- The Sound 38 has a CD Bookmark feature which allows CD playback to resume from the track and time position reached when the unit was previously put into standby mode or when you have switched to another mode.
- Clock display with either the time or time and date when in standby.
- Two alarm timers with snooze feature to wake you to either buzzer, radio or CD.
- Adjustable sleep timer which can be set to turn off after between 0 and 90 minutes.
- A 3.5mm Auxiliary input socket for playing audio from MP3 players, iPods or other audio equipment.
- A standard 3.5mm headphone socket is provided for private listening.

Note: If the unit is in the CD or the Auxiliary input stop mode position for more than 15 minutes it will automatically switch to the standby mode. The operation indicator and the LCD will go off in such a case. To use the unit again switch on the unit.

Controls

(Front)

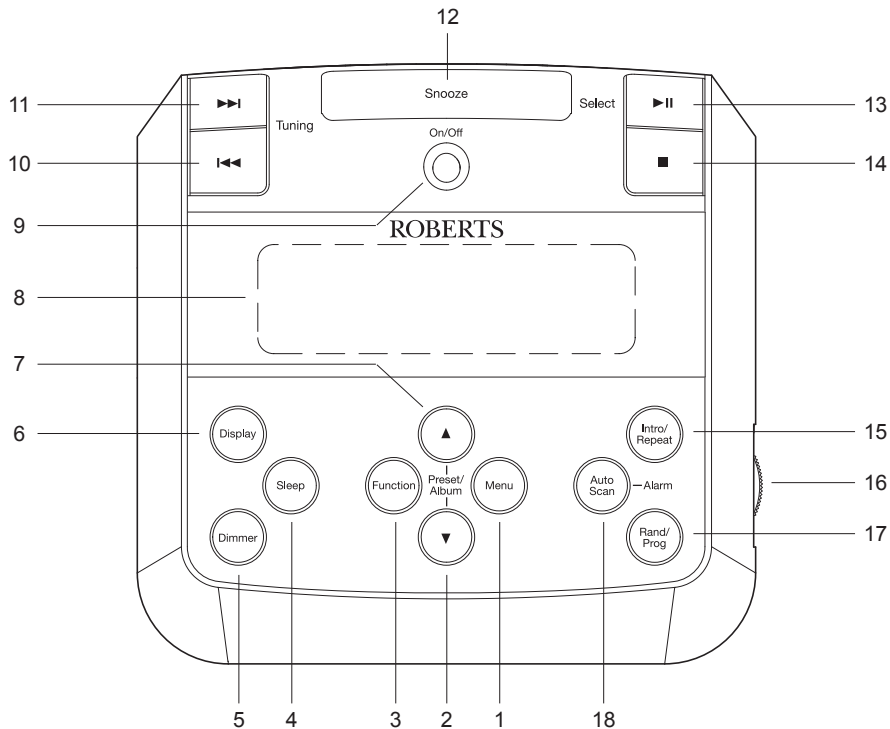

- | | | | |
|------------------------------------|---------------------------------|-------------------------------------|------------------------------|
| 1. Menu button | 6. Display button | 11. Tuning Up / Fast-forward button | 16. Volume control |
| 2. Preset / Album Down button | 7. Preset / Album Up button | 12. Snooze button | 17. Random / Program button |
| 3. Function button (DAB/FM/CD/AUX) | 8. LCD display | 13. Select / Play / Pause button | 18. Auto Scan / Alarm button |
| 4. Sleep button | 9. On / Off button | 14. Stop button | |
| 5. Dimmer button | 10. Tuning Down / Rewind button | 15. Intro / Repeat button | |

Controls

(Rear view)

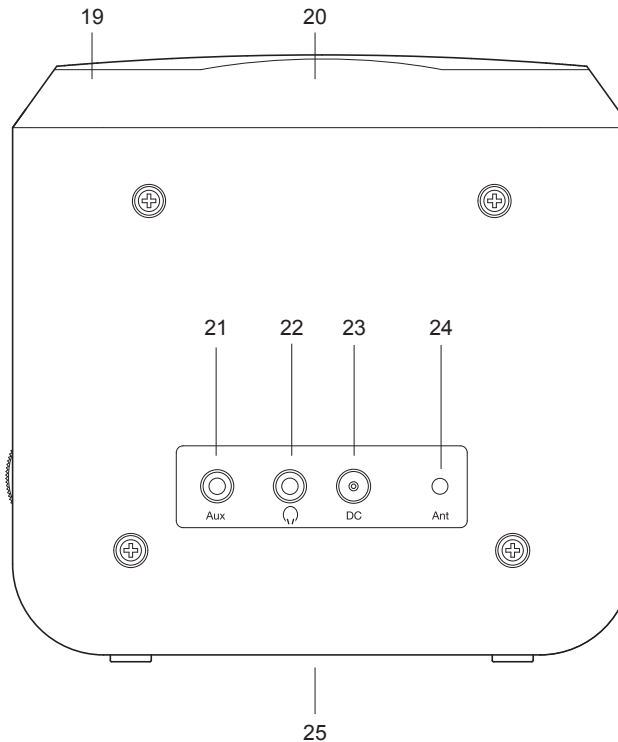

19. Open / Close CD button

20. CD lid

21. Auxiliary input socket

22. Headphone socket

23. DC input socket

24. Wire DAB / FM aerial

25. USB socket (for software upgrades)

Using your clock radio for the first time

1. Place your clock radio on a flat surface.
2. Fully extend the wire aerial located on the rear of your clock radio. Place the wire antenna so that it is as straight as possible extending either above or below the clock radio.
3. Insert the adaptor plug into the DC Input socket located on the rear of your clock radio.
4. Plug the adaptor into a standard 13amp mains socket outlet.

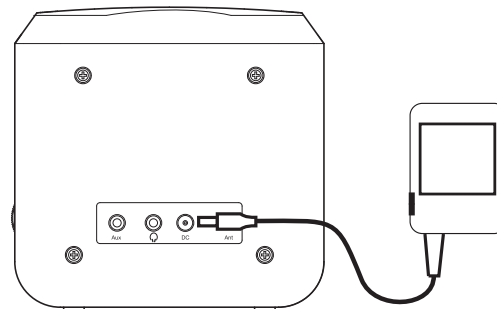

- IMPORTANT:** The mains adaptor is used as the means of connecting the clock radio to the mains supply. The mains socket used for the clock radio must remain accessible during normal use. In order to disconnect the clock radio from the mains completely, the mains adaptor should be removed from the mains socket outlet completely.
5. When your clock radio is first switched on the display will show '*Setting Clock*' and a station search will be performed automatically.
 6. When a signal has been found, the clock information will appear on the display. Press the **Display** button to toggle between showing the time only or showing both the date and time.
 7. If no signals are found '*Clock not set*' will be displayed. It may then be necessary to relocate your clock radio to a position giving better reception. You should then carry out an auto scan to find stations as described on page 9.

Setting Clock...

12:38

Clock not set...

Operating your clock radio - DAB

1. Fully extend the wire aerial located on the rear of your clock radio. Place the wire antenna so that it is as straight as possible extending either above or below the clock radio.
2. Press the **On / Off** button to switch on your clock radio. When first switched on, the clock radio will be in DAB mode. After each use the clock radio will remember the mode used and then switch on in that mode the next time it is used.
3. If this is the first time the clock radio is used a quick scan of the Band III DAB channels may be carried out (the scan is normally performed automatically when the clock is first set - page 5). If the clock radio has been used before, the last used station will be selected. If new radio stations are found, they will be added to the stored list of stations.
4. When the scan is completed the first station (in numeric-alpha order 0...9, A...Z will be selected. The first station in the list of stations found during scanning will be played. The display will show the station name in the first line of the display and other information in the second line.
5. If the station list is still empty after the scan operation your clock radio will display '*No stations available*'.
6. If no signals are found it may be necessary to relocate your clock radio to a position giving better reception, and then repeat the scan using the auto scan facility (page 9).



BBC Radio 4
Tuning...

BBC Radio 4
The latest news

No stations
available

Selecting a station - DAB

1. The top line of the display shows the name of the station currently selected.
2. Press the **Tuning Up** or **Down** buttons to scroll through the list of available stations on the lower line of the display. Stop pressing the **Tuning** buttons when you find the station that you wish to hear.
3. Press and release the **Select** button to select the station. The display may show 'Tuning' while your clock radio finds the new station.
4. Adjust the **Volume** control to the required setting.

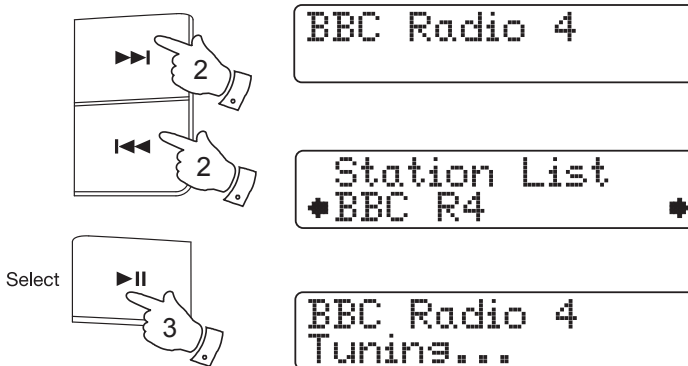

Note: If after selecting a station the display continues to show 'No stations available' it may be necessary to relocate your clock radio to a position giving better reception.

Secondary services - DAB

1. Certain radio stations have one or more secondary services associated with them. If a station has a secondary service associated with it the display will show ">>" next to the station name on the station list. The secondary service will then appear immediately after the primary service as you press the **Tuning Up** button.
2. Press and release the **Select** button to select the station.

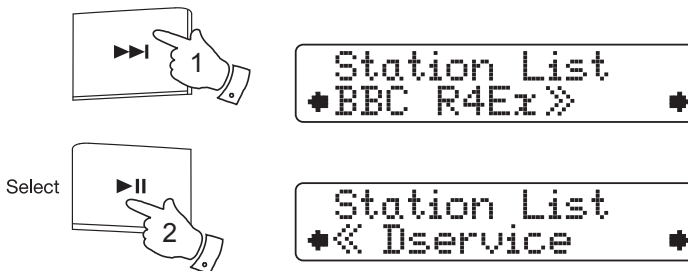

Finding new stations - DAB

As time passes new stations may become available. To find new stations proceed as follows:-

1. Press and release the **Function** button until the DAB band is selected.
2. Press and release the **Auto Scan** button. The display will show 'Scanning'.
3. Your radio will perform a scan of the Band III DAB channels. As new stations are found, the station counter on the right-hand side of the display will increase and stations will be added to the list.

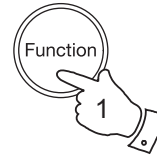

Signal strength display - DAB

1. Press and release the **Display** button until the lower line of the display shows signal strength.
2. Position your clock radio and try adjusting the aerial as to give maximum number of black rectangles on the signal strength display. Normally the best reception will be found with the aerial fully extended.
3. The clear unfilled rectangle indicates minimum signal level required for satisfactory reception.

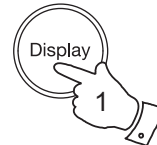

Dynamic Range Control (DRC) settings - DAB

Dynamic range control (also known as DRC) can make quieter sounds easier to hear when your clock radio is used in a noisy environment.

There are three levels of compression:

DRC 0 No compression applied. (default)

DRC 1 Maximum compression applied.

DRC 1/2 Medium compression applied.

1. Press the **On / Off** button to switch on your clock radio.
2. Press and release the **Function** button until the DAB mode is selected.
3. Press and release the **Menu** button.
4. Press the **Tuning Up** or **Down** buttons until 'DRC' appears on the display. Press and release the **Select** button. The display will show the current DRC value and it will be marked with an asterisk.
5. Press the **Tuning Up** or **Down** buttons to select the required DRC setting (default is 0).
6. Press and release the **Select** button to confirm the setting. The display will return to the normal radio display.

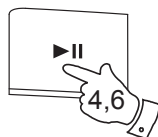
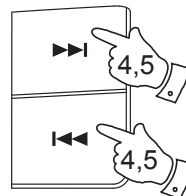
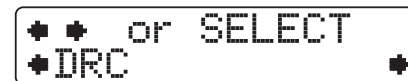
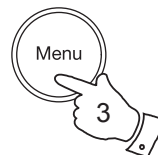
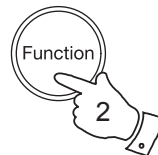

Note: Not all DAB broadcasts are able to use the DRC function. If the broadcast does not support DRC, then the DRC setting in the clock radio will have no effect.

Operating your radio - Search tuning FM

1. Fully extend the wire aerial located on the rear of your clock radio. Place the wire antenna so that it is as straight as possible extending either above or below the clock radio. Press the **On / Off** button to switch on your clock radio.
2. Press and release the **Function** button until the FM band is selected.
3. Press and release the **Tuning Up** button and then press and release the **Auto Scan** button to cause your radio to search from low frequency to high frequency and to stop automatically when it finds a station of sufficient strength.
4. After a few seconds the display will update. The display will show the frequency of the signal found. If the signal is strong enough and there is RDS data present then the radio will display the station name. The display will also show 'St' on the upper line if the station is received with stereo.
5. To find other stations press and release the **Auto Scan** button as above.
6. Press and release the **Tuning Down** button and then press the **Auto Scan** button to cause your radio to search from high frequency to low frequency and to stop automatically when it finds a station of sufficient strength.
7. When the end of the waveband is reached your radio will recommence tuning from the opposite end of the waveband.
8. Adjust the **Volume** control to the required setting.
9. To switch off your clock radio press the **On / Off** button.

On/Off



FM

2. Press and release the **Function** button until the FM band is selected.
3. Press and release the **Tuning Up** button and then press and release the **Auto Scan** button to cause your radio to search from low frequency to high frequency and to stop automatically when it finds a station of sufficient strength.
4. After a few seconds the display will update. The display will show the frequency of the signal found. If the signal is strong enough and there is RDS data present then the radio will display the station name. The display will also show 'St' on the upper line if the station is received with stereo.
5. To find other stations press and release the **Auto Scan** button as above.
6. Press and release the **Tuning Down** button and then press the **Auto Scan** button to cause your radio to search from high frequency to low frequency and to stop automatically when it finds a station of sufficient strength.
7. When the end of the waveband is reached your radio will recommence tuning from the opposite end of the waveband.
8. Adjust the **Volume** control to the required setting.
9. To switch off your clock radio press the **On / Off** button.

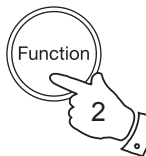

89.30MHz St FM

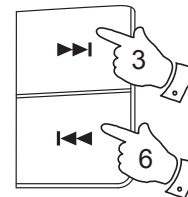

101.10MHz St FM

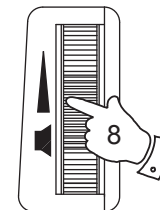

Note: If you find that FM reception is poor, try repositioning the wire aerial. Fully extend the wire aerial located on the rear of your clock radio. Place the wire antenna so that it is as straight as possible extending either above or below the radio. If you find that an FM broadcast has a lot of background hiss, this may often be reduced by setting the radio into Mono reception mode for the current FM station. Please refer to the section "Stereo / Mono setting - FM" on page 15 for further details.

Manual tuning - FM

1. Fully extend the wire aerial located on the rear of your clock radio. Place the wire antenna so that it is as straight as possible extending either above or below the radio.
2. Press the **On / Off** button to switch on your clock radio.
3. Press and release the **Function** button until the FM band is selected.
4. Repeatedly press and release the **Tuning Up** or **Down** buttons to tune to a station. The frequency will change in steps of 50kHz. If the radio is tuned to a station of sufficient signal strength with RDS information present, then the display may change to show the station name.
5. When the waveband end is reached the radio will recommence tuning from the opposite waveband end.
6. Adjust the **Volume** control to the required setting.
7. To switch off your clock radio, press the **On / Off** button.

Note: If you find that FM reception is poor, try repositioning the wire aerial. Fully extend the wire aerial located on the rear of your clock radio. Place the wire antenna so that it is as straight as possible extending either above or below the radio. If you find that an FM broadcast has a lot of background hiss, this may often be reduced by setting the radio into Mono reception mode for the current FM station. Please refer to the section "Stereo / Mono setting - FM" on page 15 for further details.

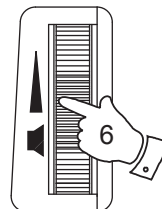
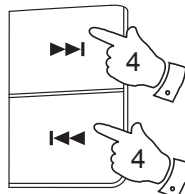
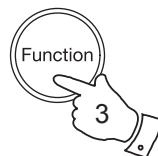

Display options - FM

Your clock radio has a range of display options for FM mode:-

The Radio Data System (RDS) is a system in which inaudible digital information is transmitted in addition to the normal FM radio programme. RDS offers several useful features. The following are available on your clock radio.

1. Press the **Display** button to cycle through the various options.

- | | |
|-------------------|--|
| a. Scrolling text | Displays scrolling text messages such as artist/track name, phone in number etc. |
| b. Programme Type | Displays the type of station being listened to e.g. Pop, Classic, News, etc. |
| c. Time and date | Displays the current time and date. |
| d. Frequency | Displays the frequency of the station being listened to. |

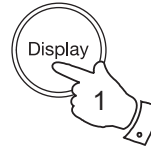

a

BBC R4	St RDS
The latest news	

b

BBC R4	St RDS
Pop Music	

c

BBC R4	St RDS
14:46	18-08-2011

d

BBC R4	St RDS
93.70MHz	FM

Note: Your radio will display 'No Radio Text' if there is no scrolling text and 'No PTY' if there is no programme type information.

Stereo / Mono setting - FM

Your radio will play stereo FM broadcasts in stereo provided that the received signal is of adequate strength. However, as a stereo signal becomes weaker the audio signal will become poorer. It may be preferable to force the radio to play the station in mono in order to reduce the level of background hiss.

1. Press the **On / Off** button to switch on your clock radio.
2. Tune to the required FM radio station as previously described (see pages 12, 13).
3. Press and release the **Select** button so that the display shows 'Radio mode: Mono'. The radio will play the current station in mono.

The mono override is a temporary setting and is applied to the currently tuned station only. It is cancelled automatically by tuning to another station.

4. If you wish to cancel the Mono override while listening to the currently tuned radio station, press and release the **Select** button so that the display shows 'Radio mode: Auto'. The radio will play the current station in stereo if the signal is sufficiently strong.

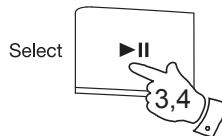

Presetting stations

You may store your preferred DAB and FM radio stations to the preset station memories. There are 20 memory presets in your clock radio, 10 for DAB and 10 for FM. Presets are remembered by your clock radio in the event of a power failure.

The procedure for setting presets and using them to tune to stations is the same for FM and DAB modes, and is described below.

1. Press the **On / Off** button to switch on your clock radio.



2. Press and release the **Function** button to select the DAB or FM waveband.
3. Tune to the required station as previously described.
4. Press and release the **Rand/Prog** button, the display will show 'Preset' with '01' flashing.
5. Press the **Preset Up** or **Down** buttons to select the desired preset number under which you wish to store the station.
6. Press and release the **Rand/Prog** button again. The display will show, for example, 'Preset 1 Saved'. The station will be stored under the chosen preset. Repeat this procedure for the other presets as needed.
7. Stations stored in preset memories may be overwritten by following the above procedure.

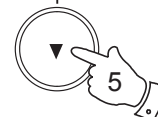
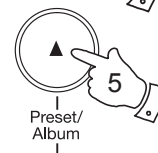
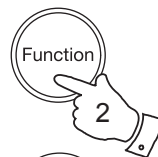

Recalling a preset station

1. Press the **On / Off** button to switch on your clock radio.
2. Select the required waveband by pressing the **Function** button.
3. Press the **Preset Up** or **Down** buttons to select the desired preset number.
4. Your clock radio will tune to the station stored in preset memory.

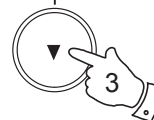
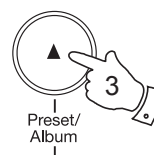
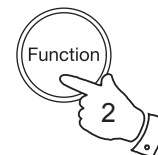

Compact discs

Use only Digital Audio CDs which have the  symbol.

Never write on a CD or attach any sticker to the CD. Always hold the CD at the edge and store it in its box after use with the label facing up.

To remove dust and dirt, breathe on the CD and wipe it with a soft, lint free cloth in a straight line from the centre towards the edge.

Cleaning agents may damage the CD.

Do not expose the CD to rain, moisture, sand or to excessive heat. (e.g from heating equipment or in motor cars parked in the sun).

CD-R/CD-RW discs

Your Sound 38 can playback CDDA format audio CD-R/CD-RW discs that have been finalised* upon completion of recording.

Your Sound 38 may fail to playback some CD-R/CD-RW discs due to poor recording and wide variation in quality of the CD-R/CD-RW disc.

*Finalising enables a CD-R/CD-RW disc to playback on audio players such as your Sound 38.

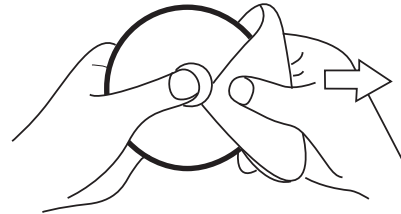

WARNING

CLASS 1 LASER PRODUCT means that the laser's construction makes it inherently safe so that the legally prescribed maximum permissible radiation values can never be exceeded.

Caution: Using any equipment or devices other than those described and specified in these operating instructions, or tampering with the unit in any way, can result in dangerous exposure to radiation.



MP3 / WMA CD Mode

The Sound 38 is able to play CD-R and CD-RW discs containing MP3 or WMA files.

In MP3/WMA mode the terms "album" and "file" are very important. "Album" corresponds to a folder on a PC, "File" to an audio track in MP3 or WMA format. The clock radio reads MP3 or WMA files with a maximum of 255 files per folder. An MP3 or WMA CD may not contain more than 512 files or albums in total. MP3 or WMA files must be created with an audio sample rate of 44.1kHz (this is normal for files created from CD audio content). Both MP3 and WMA files may be recorded on to the same media.

When burning CD-R and CD-RWs with audio files, various problems may arise which could lead to interference in playback. This can be caused by faulty software or hardware settings in your PC or by the CD being used. Should such problems arise, contact the customer services of your CD burner or software manufacturer or look for relevant information, for example on the internet. When you are making audio CDs, observe all legal guidelines and ensure that the copyright of third parties is not infringed.

Inserting a CD

1. To open the CD compartment, press and release **CD Open/Close** button in the top right hand corner.
2. Put the CD on the spindle until it clicks into place and then gently close the CD compartment by pushing the cd lid (top right hand corner) back into position.

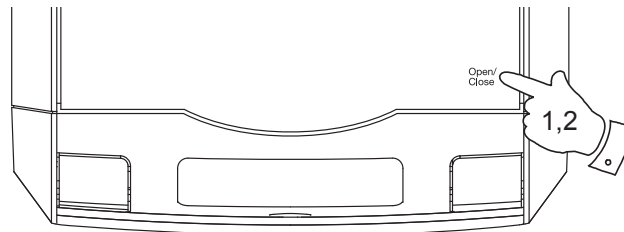

Playing a CD

1. Press the **On / Off** button to switch on your clock radio.
2. Press and release the **Function** button until the CD mode is selected.

The CD player will scan the contents of the CD and 'READING' will appear on the display.

Audio CD: the total number of tracks and total playing time will then be displayed.

MP3 / WMA CD: The total number of files and folders will then be displayed.

3. Press the **Play / Pause** button to start playback. The display will show the first track number and the play symbol ▶. The radio will also show:
Audio CD: The current track number and elapsed playing time.
MP3 / WMA CD: The current file number for 3 seconds, before changing to show the file name, ID3 tag and the elapsed playing time.
4. Adjust the **Volume** to the required settings.

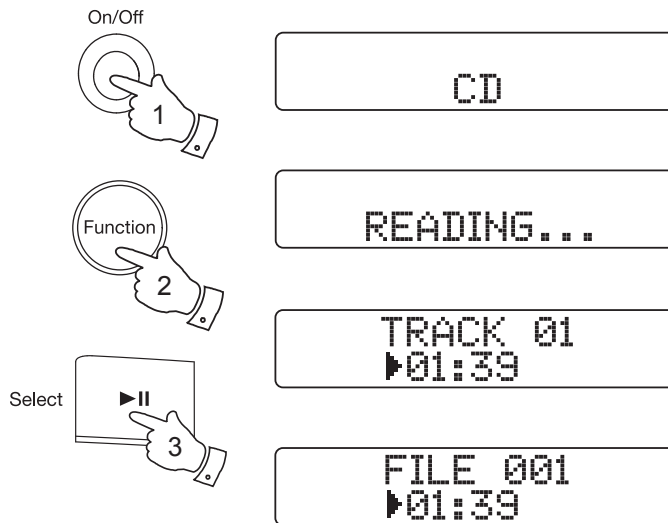

- To pause playback press the **Play / Pause** button. The pause symbol **||** will show on the display.

Audio CD: The current track number and the elapsed playing time will be shown on the display.

MP3 / WMA CD: The file name with ID3 tag scrolls, the elapsed playing time will be shown on the display.

- To continue playback press the **Play / Pause** button again.
- To stop playback, press the **Stop** button.

CD Bookmark

The CD Bookmark feature allows you to stop the playback of a CD and then to continue playback from the same point at a later time. Even if you put the clock radio into Standby mode or change the radio function, the next CD play operation will start from the point where playback was previously stopped.

Note: that if mains power is removed and restored the Bookmark setting will be cancelled and the CD will then play from the beginning.

- When the CD is playing, press the **Stop** button once. The display will then show:

Audio CD: The current track number and 'Resume'.

MP3 / WMA CD: The file number and 'Resume'.

You can then put the radio into standby or select an alternative function.

- If you wish to cancel the Bookmark function, either press the **Stop** button a second time when the radio is in CD mode, or simply take out the CD.
- To open the CD compartment, press and release **CD Open/Close** button in the top right hand corner. The CD lid should only be opened when the CD player is in stop mode.

Note: The Stop button must be pressed a second time to clear the resume memory.

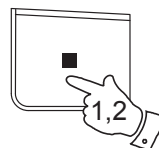
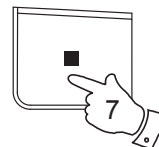
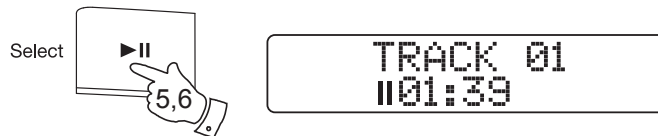

Selecting a track

1. Audio CD: While the CD is playing, press either the **Tuning Up** or **Down** buttons to change the desired track. You can also skip to a wanted track when the player is in stop mode. Press the **Play / Pause** button to play the selected track.
2. MP3 / WMA CD: While the CD is playing, press either the **Album Up** or **Down** buttons to change to the desired album / folder, then press either the **Tuning Up** or **Down** buttons to change to the desired track. You can also skip albums or tracks when the player is in stop mode. Press the **Play / Pause** button to play the selected track.

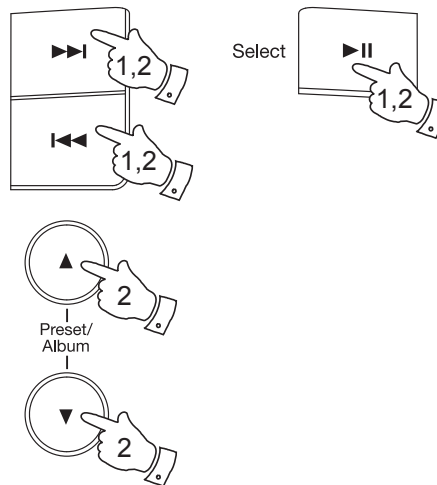

Search function



1. While the CD is playing, press and hold down either the **Tuning Up** or **Down** button. Release the button when the desired part of the track is reached.



CD repeat function

1. Whilst the CD is playing press the **Intro / Repeat** button. The clock radio will step through the following options:

Audio CD: Repeat 1  , → Repeat ALL  , → Normal Play

MP3 / WMA CD: Repeat 1  , → Repeat Folder  , → Repeat ALL  , → Normal Play

2. The display will show the currently selected repeat mode.



CD Intro function

1. When in the stop mode, press the **Intro / Repeat** button once to play the first 10 seconds of each of the tracks on the disc. 'INTRO' appears on the display.
2. To cancel the Intro mode, press and release the **Intro / Repeat** button.



CD random play

1. While the CD is playing, press and release the **Prog / Random** button to play all tracks on the CD in random order. 'RAND' will appear on the display. The tracks are played in random order until all tracks have been played.
2. Press the **Prog / Random** button again to return to normal play. 'RAND' will disappear from the display.



Creating a play list (program play)

By programming the player you can play up to 20 tracks in any desired order.

1. Whilst the CD is in Stop mode, press the **Prog / Random** button. The display will show 'P-01'.
Select the first track using the **Tuning Up or Down** buttons. 'PROG' will flash on the display. Press and release the **Prog / Random** button to store this track.
2. Repeat the above steps until you have completed your program.
3. Press the **Play / Pause** button to commence play of selected tracks.

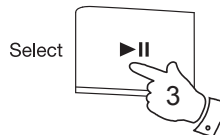
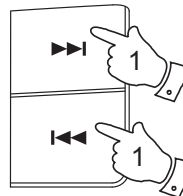

Note: Programmable play order is available on original Audio CDs, and CDDA audio on CD-R or CD-RW discs only. The programmable play feature is not available with CDs containing MP3 or WMA audio files.

Checking and editing a program

Whilst the CD is in stop mode, you can check and edit the program.

1. Press the **Prog / Random** button repeatedly. The display will show the play list that you have already programmed.
2. You can edit the playlist. When the desired track that you want to edit is reached, follow the procedure for creating a playlist page 23.



Erasing a program

1. Press the **Stop** button when in program mode to erase the program. Programs are also erased by putting the radio into standby or radio mode.

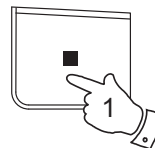

Note: If the unit is in the CD stop mode position for more than 15 minutes it will automatically switch to the standby mode. The operation indicator and the LCD will go off in such a case. To use the unit again switch on the unit.

Setting alarms

Your clock radio has four alarms which can be set to wake you by DAB, FM radio, CD or beep type alarm. Each alarm can be set to sound:

Once only

Daily

Monday to Friday

Monday to Saturday

Saturday to Sunday

Note: The alarms can only be set with the radio in standby mode.

Alarms will be retained in the event of a power failure.

If no buttons are pressed for 10 seconds, the clock radio will exit the alarm setup.

1. When your clock radio is in standby mode, press and hold the **Alarm** button. 'ALARM' appears with '1' flashing on the display.
2. Press and release the **Up** or **Down** buttons to select the desired alarm 1, 2, 3 or 4.
3. Press and release the **Alarm** button to enter the alarm mode selection menu.
4. Press the **Up** or **Down** buttons to select the desired alarm mode. You can choose between OFF, BUZZER, DAB, CD and FM. When the alarm mode is set to 'OFF' the alarm will be disabled.
5. Press and release the **Alarm** button to confirm the alarm mode. The hours digits will flash on the display.



6. Press and release the **Up** or **Down** buttons to select the desired alarm hour. Press and hold the **Up** or **Down** buttons to advance the time quickly.

7. Press and release the **Alarm** button to confirm the setting. The minute digits will flash on the display. Press and release the **Up** or **Down** buttons to select the desired alarm minute.

8. Press and release the **Alarm** button to confirm the setting and to enter the alarm day option menu. You can select between once, daily, Mon-Fri, Mon-Sat and Sat-Sun.

Display

Once	(Once)	- Will sound at one time only
Mon-Sun	(Daily)	- Will sound every day
Mon-Fri	(1-5)	- Will sound every weekday
Mon-Sat	(1-6)	- Will sound from Monday to Saturday
Sat-Sun	(6-7)	- Will sound only on weekends

9. Press the **Up** or **Down** buttons to select the desired Alarm day option.

10. Press and release the **Alarm** button to confirm the setting. 'SNOOZE 5 MIN' will show on the display.

11. Press the **Up** or **Down** buttons to select the desired snooze timer from 5, 10, 15 and 20 minutes.

12. Press and release the **Alarm** button to confirm the setting.

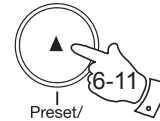

13. When the clock radio is in standby the alarm symbol  will appear if an alarm is set.

Note: When the alarm is set to wake by radio, the last used station will be switched on at the alarm time.

Note: The alarm volume will be the volume previously listened to when setting up the alarm. The volume must not be set at the lowest level. The alarm will sound for 90 minutes unless cancelled.

Make sure that a CD has been inserted when choosing CD as the alarm mode. If a CD is not present at the alarm time, the buzzer alarm will be used instead.



View the alarm time

1. Repeatedly press and release the **Alarm** button to view the time settings for Alarm 1 to Alarm 4.



To cancel the alarm

1. While an alarm is sounding it can be cancelled for 24 hours by pressing the **On / Off** button.
2. To permanently cancel an alarm, enter the alarm setup menu for the alarm that you wish to cancel. Set the alarm mode to the 'OFF' option (see step 4 on page 25).



Snooze function

1. When the alarm sounds, pressing the **Snooze** button will silence the alarm for the number of minutes specified for that particular alarm.
2. The snooze setting can be adjusted between 5, 10, 15 and 20 minutes in 5 minute increments. See "Setting alarms", step 10 on page 26.
3. To cancel the snooze function, press the **On / Off** button.

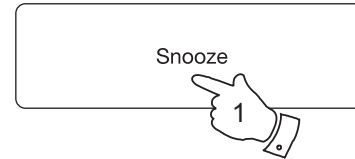

Sleep function

Your clock radio can be set to turn off after a preset time has elapsed. The sleep setting can be adjusted between 0 and 90 minutes in 10 minute increments.

1. Ensure your clock radio is switched on. Press and release the **Sleep** button. 'SLEEP' will appear on the display.
2. Repeatedly press and release the **Sleep** button to select the desired sleep time. The sleep setting will decrease in 10 minute increments from 90 minutes down to 10 minutes. A further press will cause the sleep timer to be set to 0 which will cancel the sleep function.
3. During the sleep timer countdown period, press the **Sleep** button to view the remaining time as needed or to change the sleep timer setting.
4. Your clock radio will switch off after the preset sleep time has elapsed.
5. To cancel the sleep timer and switch off your radio before the chosen sleep time has elapsed, press the **On / Off** button.
To cancel the sleep timer and leave the radio switched on, repeatedly press and release the **Sleep** button to set the sleep timer to 0 minutes.



Clock display

When your clock radio is in Standby mode you can set the display to show either the time or the time and date.

1. Press and release the **Display** button to toggle between showing the time or showing both the date and time.

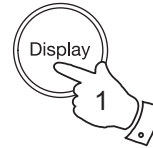

Dimmer

The brightness of the display can be adjusted while the unit is in Standby mode or while playing.

1. In order to adapt the intensity of the display to suit the ambient room lighting, press the **Dimmer** button to select the dimmer brightness from High, Mid, Low and an almost off 'night-time' setting.

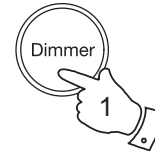

Software version

The software display cannot be altered and is just for your reference. Ensure your clock radio is switched on.

1. Press and release the **Function** button to select either the DAB or FM mode.
2. Press and release the **Menu** button.
3. Press the **Tuning Up or Down** buttons until 'SW version' appears on the display.
4. Press and release the **Select** button to view the software information.
5. After several seconds your clock radio will exit the menu.

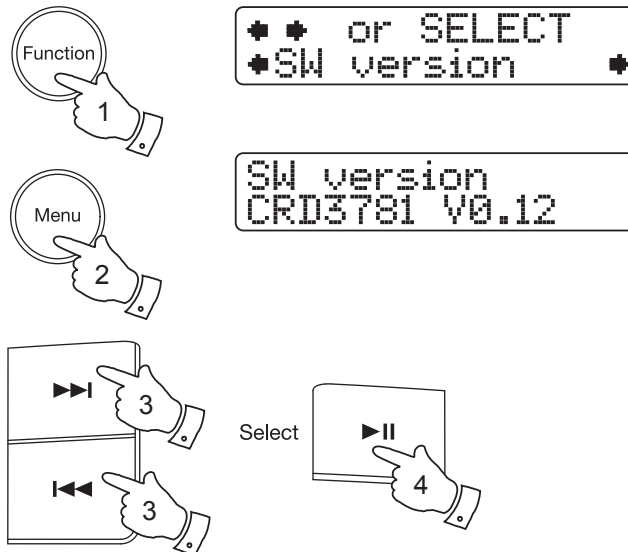

USB socket for software upgrade

As software updates become available software and information on how to update your clock radio may be found at www.robertsradio.com

System reset

If your clock radio fails to operate correctly, or some digits on the display are missing or incomplete carry out the following procedure.

1. Ensure your clock radio is switched on. Press and release the **Function** button to select either the DAB or FM mode.
2. Press and release the **Menu** button.
3. Press the **Tuning Up** or **Down** buttons until 'Factory Reset' appears on the display. Press and release the **Select** button.
4. Press the **Tuning Up** or **Down** buttons until 'Yes' is highlighted on the display. If you do not wish to carry out a system reset, highlight 'No' and then press the **Select** button. The display will revert to the previous menu.
5. With 'Yes' selected, press and release the **Select** button. A full reset will be performed. The station list and presets will be erased. Alarms will be cancelled and snooze and sleep timer settings will be set to their default values. The display will show 'Restarting' and after a few seconds a station scan search will be performed automatically. The display will show progress of the station search. The number on the right of the display is the number of stations that have been found.

In case of malfunction due to electrostatic discharge, reset the product as above to resume normal operation. If you are not able to perform the reset operation as above, removal and reconnection of the power supply may be required.

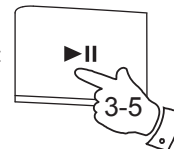
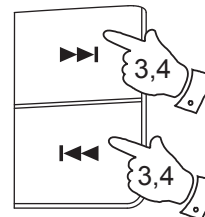
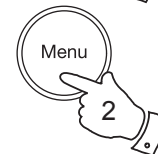
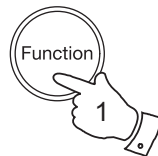

Select

Headphone socket

A 3.5mm stereo **Headphone Socket** is provided on the rear of your clock radio for use with headphones or an earpiece. Inserting a plug automatically mutes the internal loudspeakers.

Please be aware that the sensitivity of headphones can vary widely. We therefore recommend setting volume to a low level before connecting headphones to the clock radio.

IMPORTANT: Excessive sound pressure from earphones and headphones can cause hearing loss.



To prevent possible hearing damage, do not listen at high volume levels for long periods.

Auxiliary Input (Line in) socket

A 3.5mm stereo **Auxiliary Input socket** is provided on the rear of your clock radio to permit an audio signal to be fed into the unit from an external audio device such as iPod, MP3 or CD player.

1. Connect a stereo or mono audio source (for example, iPod, MP3 or CD player) to the **Auxiliary Input socket** (marked "Aux").
2. Press and release the **Function** button until 'AUX' is selected on the display.
3. Adjust the **Volume control** on your iPod, MP3 or CD player to ensure an adequate signal and then adjust the volume on the clock radio for comfortable listening.

Note: If the unit is in the Auxiliary input stop mode position for more than 15 minutes it will automatically switch to the standby mode. The operation indicator and the LCD will go off in such a case. To use the unit again switch on the unit.

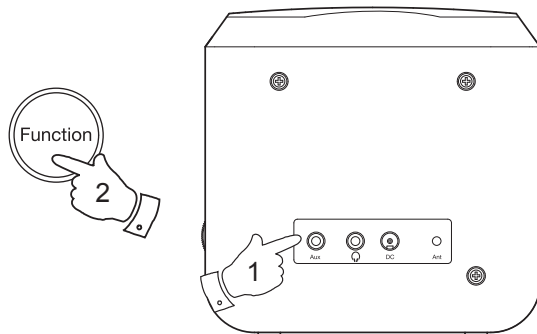
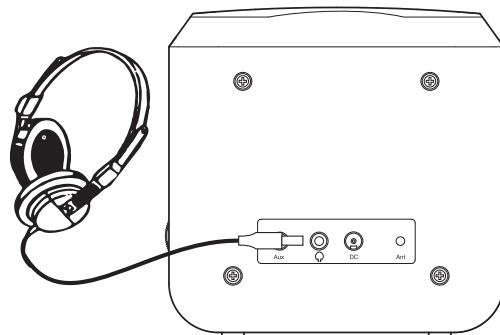

Cautions

Do not allow this clock radio to be exposed to water, steam or sand. Do not leave your radio where excessive heat could cause damage. It is recommended that the DAB band be used wherever possible as better results in terms of quality and freedom from interference will usually be obtained than on the FM band.

- The name plate is located on the underside of your clock radio.



- The clock radio shall not be exposed to dripping or splashing and that no objects filled with liquids, such as vases, shall be placed on the radio.
- It is recommended to operate the product such that there is a minimum distance (10cm recommended) to adjacent objects in order to ensure good ventilation.
- The ventilation of the product should not be restricted by covering it or its ventilation openings with items such as newspapers, table-cloths, curtains etc.
- No naked flame sources such as lighted candles should be placed on the product.
- It is recommended to avoid using or storing the product at extremes of temperature. Avoid leaving the unit in cars, on window sills in direct sunlight etc.

Specifications

Power Requirements

Mains AC 100 \sim 240V 50/60Hz (Adaptor)

Frequency Coverage

FM	87.5-108MHz
DAB	174.928 - 239.200MHz

Circuit features

Loudspeakers 78mm

Output power 2 x 1W

Headphone socket 3.5mm dia

Auxiliary input socket 3.5mm dia

Aerial System	FM	Wire aerial
	DAB	Wire aerial

The Company reserves the right to amend the specification without notice.

Guarantee

This product is guaranteed for twelve months from the date of purchase by the original owner against failure due to faulty workmanship or component breakdown, subject to the procedure stated below. Should any component or part fail during this guarantee period it will be repaired or replaced free of charge.

The guarantee does not cover:

1. Damage resulting from incorrect use.
2. Consequential damage.
3. Product with removed or defaced serial numbers.

Procedure:

Any claim under this guarantee should be made through the dealer from whom the product was purchased. It is likely that your Roberts dealer will be able to attend to any defect quickly and efficiently, but should it be necessary the dealer will return the product to the company's service department for attention. In the event that it is not possible to return the product to the Roberts dealer from whom it was purchased, please contact Roberts Radio using the contact details on the www.robertsradio.com website.

For product repairs falling outside the guarantee period, please refer to the "customer care" tab on the www.robertsradio.com website.

These statements do not affect the statutory rights of a consumer.

ROBERTS RADIO LIMITED

PO Box 130
Mexborough
South Yorkshire
S64 8YT

Website: <http://www.robertsradio.com>

