

ROBERTS

Enjoy Listening

CD / DAB / FM Digital Sound System
with dock for iPod® and iPhone®

S O U N D 1 0 0



DAB

Digital Audio Broadcasting

Please read this manual before use

Contents

| | | | |
|--|-------|--|-------|
| Introduction | 2-9 | <i>MP3 / WMA CD mode</i> | 30 |
| <i>Sound 100 Sound System features</i> | 3 | <i>MP3 / WMA file and folder selection</i> | 31-32 |
| <i>Controls and connections</i> | 4-5 | iPod and iPhone docking | 33-34 |
| <i>Remote control</i> | 6-7 | <i>Navigating your iPod</i> | 34 |
| <i>Display icons</i> | 8 | <i>Playing a file on your iPod</i> | 34 |
| <i>Accessing the menu system</i> | 8 | Clock and Alarms | 35-43 |
| <i>Using the sound system for the first time</i> | 9 | <i>Alarms</i> | 35-37 |
| DAB radio | 10-16 | <i>Cancelling alarms</i> | 37 |
| <i>Operating your sound system - DAB</i> | 10 | <i>Snooze</i> | 38 |
| <i>Selecting a station - DAB</i> | 11 | <i>Sleep function</i> | 39 |
| <i>Secondary services - DAB</i> | 11 | <i>Setting the clock manually</i> | 40-41 |
| <i>Display options - DAB</i> | 12-13 | <i>To return to auto clock set mode</i> | 42 |
| <i>Finding new stations - DAB</i> | 13 | <i>Standby brightness control</i> | 43 |
| <i>Manual tuning - DAB</i> | 14 | Audio and Setup | 44-50 |
| <i>Dynamic range control - DAB</i> | 15 | <i>Equalizer function</i> | 44-45 |
| <i>Station order setup - DAB</i> | 16 | <i>Treble and Bass settings</i> | 45 |
| FM radio | 17-24 | <i>Mute function</i> | 46 |
| <i>Operating your radio - search tuning FM</i> | 17 | <i>USB socket for software upgrades</i> | 46 |
| <i>Manual tuning - FM</i> | 18 | <i>Software version displays</i> | 47 |
| <i>Display options - FM</i> | 19 | <i>System reset</i> | 48 |
| <i>FM stereo / mono</i> | 20 | <i>Headphone socket</i> | 49 |
| <i>Scan sensitivity setting - FM</i> | 21 | <i>Aerial removal</i> | 49 |
| <i>Presetting stations - DAB and FM</i> | 22-23 | <i>Auxiliary input socket</i> | 50 |
| <i>Language function - DAB and FM</i> | 24 | Information | 51-54 |
| CD / MP3 / WMA | 25-32 | <i>Cautions</i> | 51 |
| <i>Compact discs</i> | 25 | <i>Specifications</i> | 51 |
| <i>Playing a CD</i> | 26-27 | <i>Mains supply</i> | 52 |
| <i>Repeat and shuffle options</i> | 28-29 | <i>Guarantee</i> | 54 |

About this instruction manual

This instruction manual is split into sections for each of the different operating modes of your Roberts Sound 100 Digital Sound System. The introduction describes the features and controls of the product.

There are six sections covering the main features in detail - DAB radio, FM radio, CD / MP3 / WMA playback, iPod and iPhone docking, Clock and Alarm, and Audio and Setup. Each section is clearly identified by the shaded heading in the top right hand corner of each pair of pages.

The two sections for **DAB Radio** and **FM Radio** describe how to use the sound system to listen to radio broadcasts.

The section for **CD / MP3 / WMA player** describes how to play digital audio CDs or MP3 / WMA files which have previously been recorded to CD-R or CD-RW.

The section for **iPod** and **iPhone docking** describes how to use your Sound 100 to play audio files or video soundtracks directly from your iPod and iPhone.

The section titled **Clock** and **Alarms** describes setting the clock, as well as explaining the use of the alarms, snooze and sleep timer features.

The **Audio** and **Setup** section describes how to use the audio equalizer and tone controls and how to connect other audio equipment.

Lastly, the **Information** section includes safety, specifications and warranty information.

*If you need any further advice, please call our Technical Helpline on :-
020 8758 0338 (Mon-Fri)*

Introduction

Introduction

(page 2)

DAB Radio

(page 10)

FM Radio

(page 17)

CD / MP3 / WMA

(page 25)

iPod and iPhone Docking

(page 33)

Clock and Alarms

(page 35)

Audio and Setup

(page 44)

Information

(page 51)

Sound 100 Sound System features

The Roberts Sound 100 Digital Sound System provides the following range of features in an attractive compact unit:-

- Radio for DAB and FM (with RDS) broadcasts.
- Audio CD player with track search and repeat and shuffle facility (can also play CD-R, CD-RW discs). *
- Playback of MP3 and WMA files which have been recorded to CD-R or CD-RW.
- 20 radio station presets (10 for DAB and 10 for FM).
- iPod docking connector to play your music collection or video soundtracks from your iPod and iPhone.
- Clock display with time and date when in standby.
- Two alarm timers with snooze feature to wake you to either buzzer, radio, CD or iPod (with humane wake system on buzzer alarm).
- Adjustable sleep timer which can be set to turn the sound system off after between 15 and 120 minutes.
- Easy-to-read 2 line text display with large clock display.
- A 3.5mm stereo Auxiliary Input socket for playing audio from MP3 players, iPod devices which cannot use the dock connector, or other audio equipment.
- A standard 3.5mm headphone socket for private listening.
- High quality, full range, stereo speakers (2 x 7W).
- An acoustically tuned, hand finished cabinet that includes bass ports and internal bracing for optimal sound reproduction.
- Low power consumption when in standby mode.

Note:

- * 8cm (mini) CDs cannot be played. Transparent or partly transparent CDs cannot be played. Unusually thin (Eco) CDs cannot be played. Some copy-protected CDs may not be playable.

(Top)

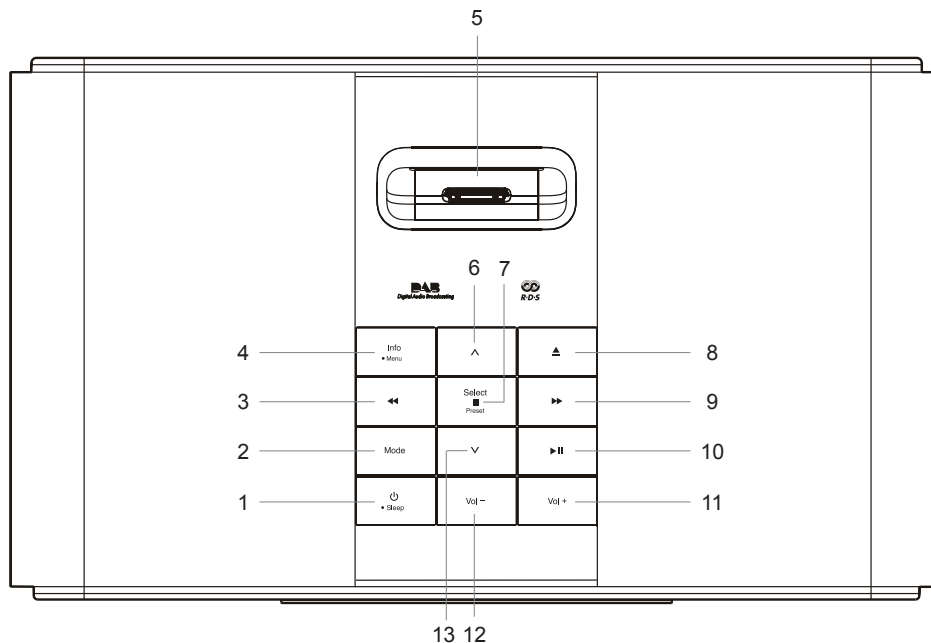

- | | |
|---|------------------------------------|
| 1. On / Standby / Sleep button | 8. CD eject button |
| 2. Mode button | 9. Tuning Up / Fast-forward button |
| 3. Tuning Down / Rewind button | 10. Play / Pause button |
| 4. Info / Menu button | 11. Volume Up button |
| 5. Dock connector for iPod® and iPhone® | 12. Volume Down button |
| 6. Folder Up button | 13. Folder Down button |
| 7. Select / Preset / CD Stop button | |

Controls and connections

(Front)

- 14. Standby indicator
- 15. LCD display
- 16. Infra-red sensor
- 17. CD loaded indicator
- 18. CD slot

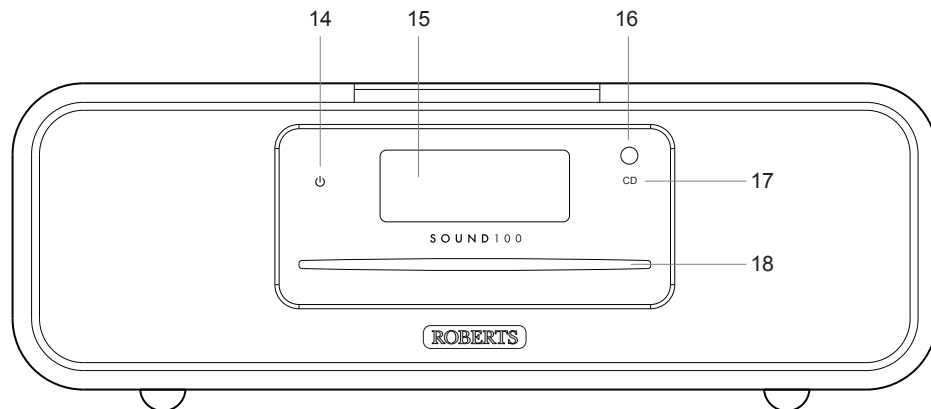

(Rear)

- 19. Telescopic aerial
- 20. USB socket (for software upgrades only)
- 21. Mains input socket
- 22. Headphone socket
- 23. Auxiliary input socket

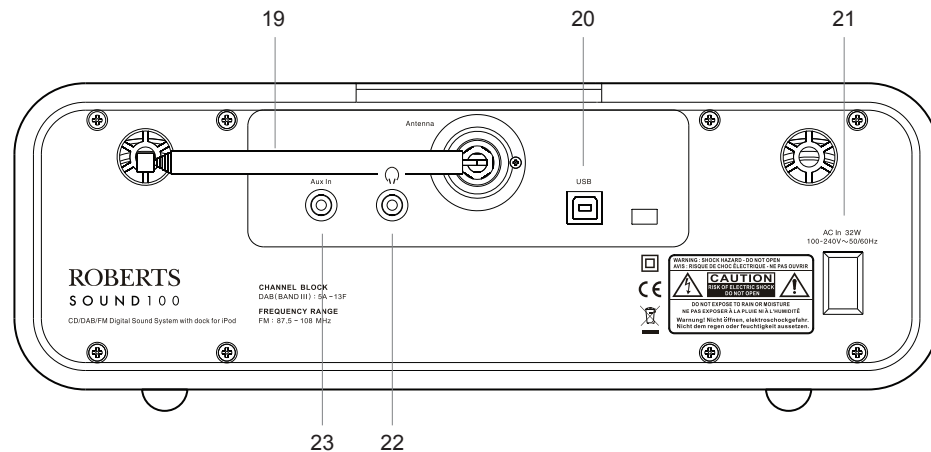

Remote control

All the functions of the Sound 100 Sound System can be controlled using either the sound system buttons or the remote control.

1. On / Standby / Sleep button
2. Mode button
3. Info / Menu button
4. Tuning Down / Rewind button
5. Folder Up button
6. Tuning Up / Fast-forward button
7. Play / Pause button
8. Volume Down button
9. Volume Up button
10. Select / Preset / CD Stop button
11. Folder Down button

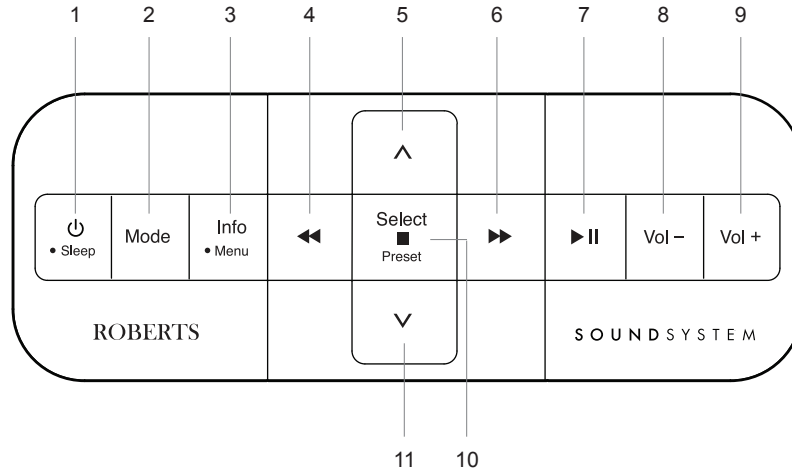

Remote control battery replacement

1. Remove the battery cover on the rear of your remote control by applying pressure to the catch in the direction shown by the arrow and then lifting off the cover.
2. Remove the battery from the battery compartment by pressing the right hand bottom corner of the battery so that the battery is released from its position. (see illustration) The battery can now be lifted out.
3. Replace the battery (CR2032 or equivalent) ensuring that the positive side of the battery remains visible as the battery is inserted. Place the battery under the lip in the bottom right hand corner then click into place.
4. Close the battery cover by inserting the retaining lug first, then apply pressure to the free end such that the catch latches the cover securely.
5. If the remote is not to be used for an extended period of time it is recommended that the batteries are removed.

IMPORTANT: The batteries should not be exposed to excessive heat such as sunshine, fire or the like. After use, disposable batteries should if possible be taken to a suitable recycling centre. On no account should batteries be disposed of by incineration.

1. Catch
2. Battery compartment
3. Retaining lug (inside)

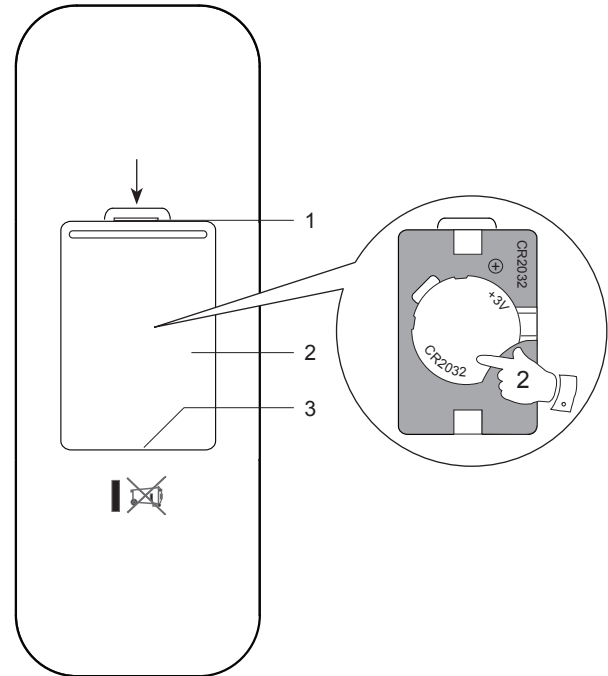

Display icons

- A. Sleep indicator
- B. Alarm 1 and 2 indicators
- C. Snooze indicator
- D. Speaker indicator
- E. Clock digits
- F. FM indicator
- G. DAB indicator
- H. Stereo indicator
- I. CD indicator
- J. WMA indicator
- K. MP3 indicator
- L. Repeat all files indicator
- M. Repeat folder indicator
- N. Repeat single file indicator
- O. Aux input indicator
- P. Two line text display

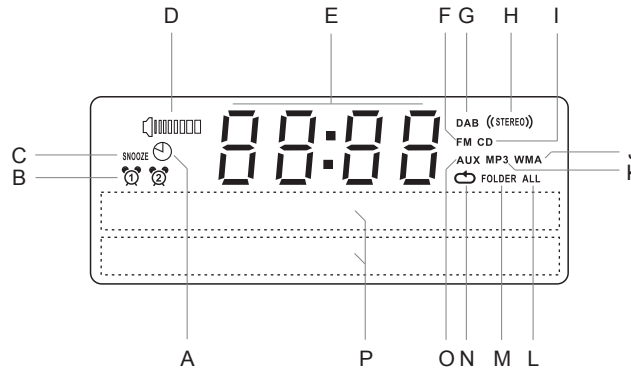

Accessing the menu system

1. To access the menu system, press and hold the **Menu** button.
2. To exit the menu system, press and release the **Menu** button as needed.

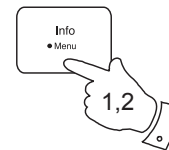

Using the sound system for the first time

1. Place your sound system on a flat surface.
2. Fully extend the telescopic aerial. The aerial should be fully extended and positioned vertically for optimum reception.
3. Plug the mains lead into the mains socket located on the back of your sound system ensuring that the plug is pushed fully into the socket.
4. Plug the other end of the mains lead into the wall socket and switch on the wall socket.

IMPORTANT: The mains plug is used as the means of connecting the sound system to the mains supply. The mains socket used for the sound system must remain accessible during normal use. In order to disconnect the sound system from the mains completely, the mains plug should be removed from the mains socket outlet completely.

5. When your sound system is first switched on the clock display will show 12:00 and the unit will enter standby mode. It will then scan for DAB radio stations and when stations have been found the clock and date should be set automatically. Note that the display will not show any scanning message for this first scan.
6. If no stations have been found then the clock will not set. You may need to relocate your sound system to a position giving better reception. You should then carry out an auto-tune to find DAB stations. See DAB Operation on page 10 and also Finding New Stations on page 13. The clock will then be set from a DAB broadcast.

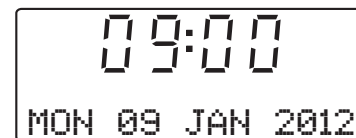
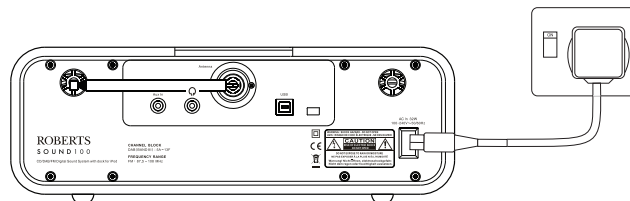

Operating your sound system - DAB

1. Fully extend the telescopic aerial.
2. If your sound system is in standby mode, press and release the **On / Standby** button to switch it on.
3. Press and release the **Mode** button until the DAB mode is selected. The display will show 'DAB' for a few seconds.
4. If this is the first time the sound system is used a quick scan of Band III DAB channels may be carried out (depending on whether scanning was already completed in standby mode). If the radio has been used before, the last used station will be selected.
5. When first switched on, the first station in the list of stations found will be played. The display will show the station name on the upper line of the text display and broadcast information on the lower line.
6. If the station list is still empty after the scan operation or if the selected station cannot be received your radio will display 'No DAB Station'.
7. If no signals are found it may be necessary to relocate your sound system to a position giving better reception, and then repeat the scan using the Auto-tune facility (see Finding New Stations on page 13).

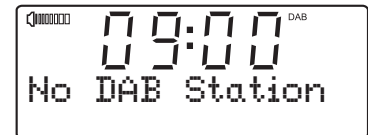
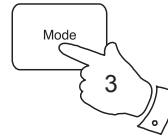
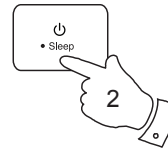

Note: that radio station name and frequency displays shown in this user guide may differ from those that you see on your radio. Broadcasters may change radio station names that are transmitted, and the frequencies used for DAB and FM radio stations may not be the same in all parts of the country.

Selecting a station - DAB

1. When the unit is in DAB mode the upper line of the text display normally shows the name of the station currently tuned.
2. Repeatedly press the **Tuning Up** or **Down** buttons to scroll through the list of available stations on the lower line of the text display. Stop pressing the **Tuning** buttons when you find the station that you wish to hear. If you keep pressing one of the tuning buttons then the unit will rapidly scroll through the list of available stations.

3. Press and release the **Select** button to cause the radio to tune to the chosen station. The display may show 'Connecting' while your radio finds the new station.

The use of memory presets is described on page 22.

4. Adjust the **Volume** to the required setting.

If after selecting a station the display shows 'No DAB Station' it may be necessary to relocate your radio to a position giving better reception.

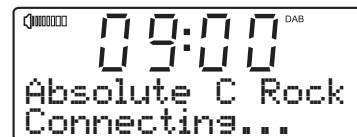
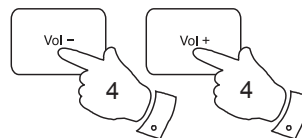
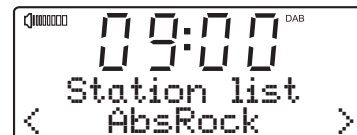
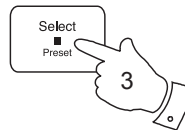
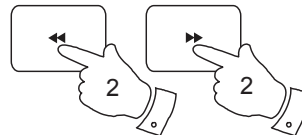

Secondary services - DAB

1. Certain radio stations have one or more secondary services associated with them. If a station has a secondary service associated with it the display will show '>>' next to the station name on the station list. The secondary service will then appear immediately after the primary service as you press the **Tuning Up** button.
2. Press and release the **Select** button to select the station.

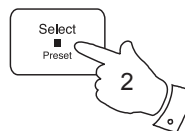
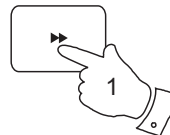

Display options - DAB

When in DAB mode your radio has a range of display options.

1. Press and release the **Info** button to cycle through the various options.

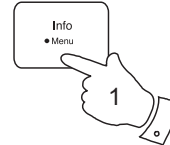

- a. Scrolling text Displays scrolling text messages such as artist/track name, phone in number, etc.
- b. Programme type Displays the type of station being listened to e.g. Pop, Classic, News, etc.
- c. Multiplex Name Displays the name of the DAB multiplex to which the current station belongs.
- d. Date Displays the current date.
- e. Channel & frequency Displays the channel number and frequency for the current DAB radio station.



Display modes - DAB cont.

f. Bit rate/audio type Displays the digital bit rate and audio type for the current DAB radio station.

g. Signal strength Displays signal strength for the station being listened to. The clear rectangle shows the minimum required signal strength for clear DAB reception.



Finding new stations - DAB

As time passes new stations may become available. To find new stations proceed as follows:-

1. Press and hold the **Menu** button. 'DAB Menu' will appear on the display.
2. Press and release the **Select** button to enter the DAB menu.
3. Press the **Tuning Up** or **Down** buttons until 'Scan' appears on the display.
4. Press and release the **Select** button. The display will then show 'Scanning...' and your sound system will perform a scan of the Band III DAB channels. As new stations are found the station counter on the right-hand side of the display will increase and any new stations will be added to the list stored in the sound system.

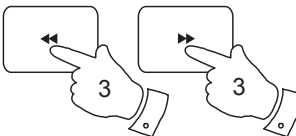
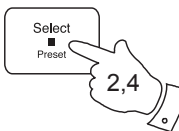
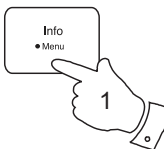

Manual Tuning - DAB

Manual tuning allows you to tune your radio to a particular DAB frequency in Band III. Any new stations found will be added to the station list. This function can also be used to assist the positioning of the aerial or sound system to optimise reception for a specific channel or frequency. UK DAB stations are located in the range 11B to 12D.

1. Press and hold the **Menu** button. 'DAB Menu' will appear on the display.
2. Press and release the **Select** button to enter the DAB menu.
3. Press the **Tuning Up** or **Down** buttons until 'Manual tune' appears on the display. Press and release the **Select** button.
4. Press the **Tuning Up** or **Down** buttons to select the desired DAB channel.
5. Press and release the **Select** button. The open block in the signal strength graph shows the minimum signal strength needed for good DAB reception. The signal blocks will go up and down showing the changing signal strength as you adjust the telescopic aerial or the sound system position. Any new radio stations found on the tuned DAB multiplex will be added to the list stored in the radio.
6. Any new stations that are found are automatically added to the stored list of stations.
7. Press and release the **Select** button to return to normal tuning mode.

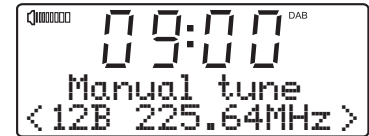
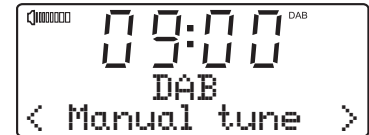
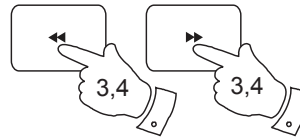
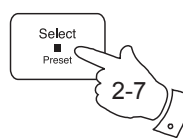
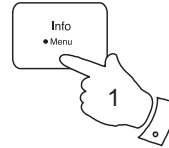

Dynamic Range Control (DRC) settings - DAB

Dynamic range control (also known as DRC) can make quieter sounds easier to hear when your sound system is used in a noisy environment.

There are 3 levels of compression:

DRC Off - No compression applied. (default)

DRC High - Maximum compression applied.

DRC Low - Medium compression applied.

1. Press and release the **On / Standby** button to switch on your sound system. Press and release the **Mode** button until the DAB mode is selected.
2. Press and hold the **Menu** button. 'DAB Menu' will appear on the display. Press and release the **Select** button to enter the DAB menu.
3. Press the **Tuning Up** or **Down** buttons until the display shows 'DRC'.
4. Press and release the **Select** button to enter the DRC adjustment menu.
5. Press the **Tuning Up** or **Down** buttons to select the required DRC setting (the default is Off).
6. Press and release the **Select** button to confirm the setting. The display will then return to the previous radio display.

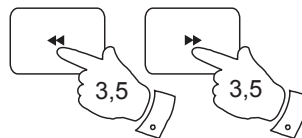
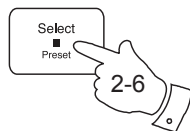
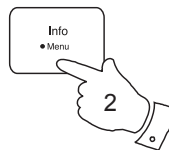
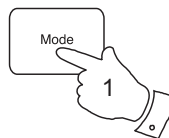

Note: Not all DAB broadcasts are able to use the DRC function. If the broadcast does not support DRC, then the DRC setting in the radio will have no effect.

Station order setup - DAB

Your sound system has 2 station order settings from which you can choose. The station order settings are, alphanumeric and ensemble.

Note: The default station order setting is alphanumeric.

1. Press and release the **On / Standby** button to switch on your sound system. Press and release the **Mode** button until the DAB mode is selected.
2. Press and hold the **Menu** button. 'DAB Menu' will appear on the display. Press and release the **Select** button to enter the DAB menu.
3. Press the **Tuning Up** or **Down** buttons until 'Station order' appears on the display. Press and release the **Select** button to enter the station order selection menu.
4. Press the **Tuning Up** or **Down** buttons to choose between alphanumeric or ensemble. The chosen station order setting will be marked with an asterisk.
'Alphanumeric' - sorts the station list alpha-numerically 0...9 A...Z.
'Ensemble' - organises the station list by DAB multiplex.
 Most users will find it best to leave the station order set to Alphanumeric.
5. Press and release the **Select** button to select the required station order.

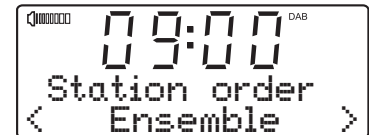
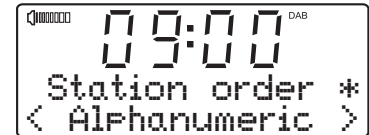
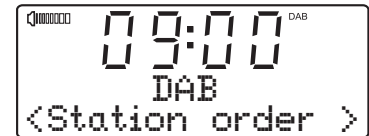
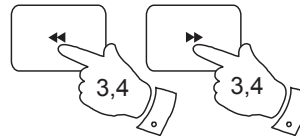
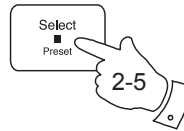
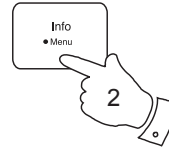
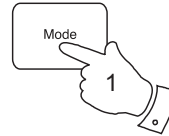

Operating your radio - Search tuning FM

1. Fully extend the telescopic aerial. The aerial should be fully extended and positioned vertically for optimum reception.
2. Press and release the **On / Standby** button to switch on your sound system.
3. Press and release the **Mode** button until the FM band is selected.
4. Press and hold down the **Tuning Up** button for 2 - 3 seconds to cause your radio to search from low frequency to high frequency and to stop automatically when it finds a station of sufficient strength.
5. After a few seconds the display will update. The display will show the frequency of the signal found. If the signal is strong enough and there is RDS data present then the radio will display the station name.
6. To find other stations press and hold the **Tuning Up** button as before.
7. Press and hold down the **Tuning Down** button for 2 - 3 seconds to cause your radio to search from high frequency to low frequency and to stop automatically when it finds a station of sufficient strength.
8. When the end of the waveband is reached your radio will recommence tuning from the opposite end of the waveband.
9. Adjust the **Volume** to the required setting.
10. To switch off your radio press and release the **On / Standby** button.

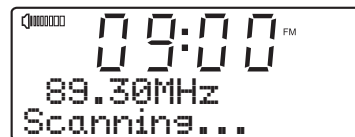
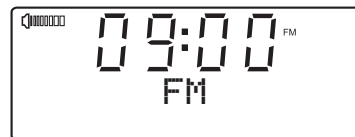
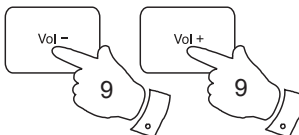
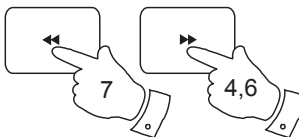
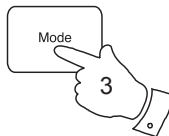
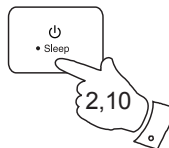

Note:

If you find that FM reception is poor, try repositioning the telescopic aerial. Fully extend and position vertically for optimum reception. If you find that an FM broadcast has a lot of background hiss, this may often be reduced by setting the radio into Mono reception mode for the current FM station. Please refer to the section 'Stereo / Mono setting - FM' on page 20 for further details.

Manual tuning - FM

1. Fully extend the telescopic aerial. The aerial should be fully extended and positioned vertically for optimum reception.
2. Press and release the **On / Standby** button to switch on your sound system.
3. Press and release the **Mode** button until the FM band is selected.
4. Repeatedly press and release the **Tuning Up** or **Down** buttons to tune to a station. The frequency will change in steps of 50kHz.
If the radio is tuned to a station of sufficient signal strength with RDS information present, then the display may change to show the station name.
5. When the end of the waveband is reached the radio will recommence tuning from the opposite end.
6. Set the **Volume** to the desired setting.
7. To switch off your sound system press and release the **On / Standby** button.

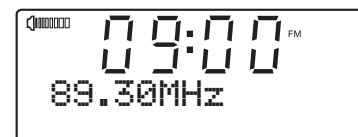
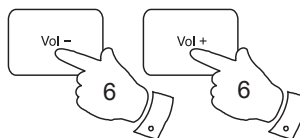
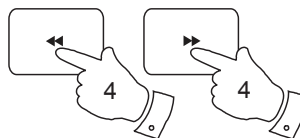
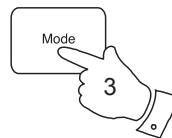
**Note:**

If you find that FM reception is poor, try repositioning the telescopic aerial. Fully extend and position vertically for optimum reception. If you find that an FM broadcast has a lot of background hiss, this may often be reduced by setting the radio into Mono reception mode for the current FM station. Please refer to the section 'Stereo / Mono setting - FM' on page 20 for further details.

Display options - FM

Your sound system has a range of display options for FM mode:-

The Radio Data System (RDS) is a system in which inaudible digital information is transmitted in addition to the normal FM radio programme. RDS offers several useful features. The following are available on your sound system.

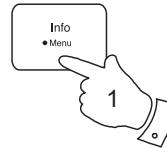

1. Press and release the **Info** button to cycle through the various modes.

- | | |
|-------------------|---|
| a. Radio text | Displays scrolling text messages such as artist / track name, phone in number, etc. |
| b. Programme Type | Displays the type of station being listened to e.g. Pop, Classic, News, etc. |
| c. Time | Displays the current time (24 hour format). |
| d. Date | Displays the current date. |
| e. Station name | Displays the name of the station being listened to. |

Note: If no RDS information is available, the radio will be unable to display the station name, radio text and programme type information. If the signal is too weak then the radio will display only the FM frequency and the optional Stereo indicator.

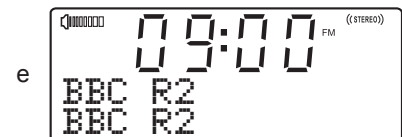
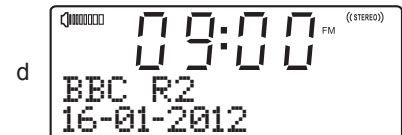
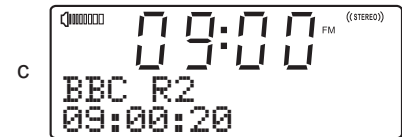
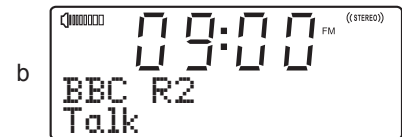

Stereo / Mono setting - FM

Your radio will play stereo FM broadcasts in stereo provided that the received signal is of adequate strength. However, as a stereo signal becomes weaker the audio signal will become poorer. It may be preferable to force the radio to play the station in mono in order to reduce the level of background hiss.

1. Press and release the **On / Standby** button to switch on your sound system.
2. Tune to the required FM radio station as previously described (see pages 17, 18).
3. Press and hold the **Menu** button. 'FM Menu' will appear on the display. Press and release the **Select** button to enter the FM menu.
4. Press the **Tuning Up** or **Down** buttons until 'Audio setting' appears on the display. Press and release the **Select** button.
5. To switch to mono to reduce the hiss from a weak FM signal press the **Tuning Up** or **Down** buttons until 'Forced mono' appears on the display. Press and release the **Select** button to confirm the setting.

Alternatively, to return to normal automatic 'stereo or mono' press the **Tuning Up** or **Down** buttons until 'Stereo allowed' appears on the display. Press and release the **Select** button to confirm the setting.

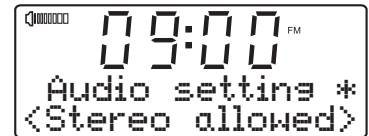
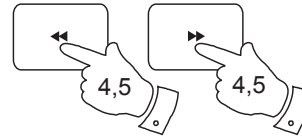
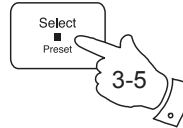
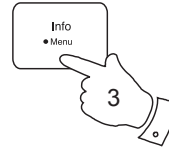

Scan sensitivity setting - FM

Your radio will normally scan for FM broadcasts which are strong enough to give good reception. However, you may wish the Auto-scan function to also be able to find weaker signals, possibly from more distant radio transmitters. Your radio includes a local / distant option for the Auto-scan function.

1. Press and release the **On / Standby** button to switch on your sound system.
2. If needed, press the **Mode** button until the FM band is selected.
3. Press and hold the **Menu** button. 'FM Menu' will appear on the display. Press and release the **Select** button to enter the FM menu.
4. Press the **Tuning Up** or **Down** buttons until 'Scan setting' shows on the display. Press and release the **Select** button to enter the scan sensitivity adjustment mode.
5. Press the **Tuning Up** or **Down** buttons to switch between Local ('Strong stations only') and Distant ('All stations') options on the lower line of the display. The Distant option will allow the radio to find weaker signals when scanning.
6. Press and release the **Select** button to confirm your selection. The Local or Distant setting is stored in the radio and remains in force until changed or until a System Reset.

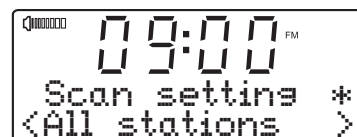
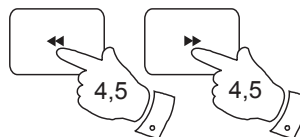
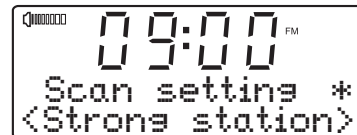
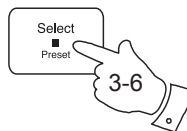
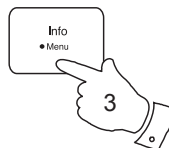
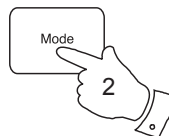

Note: The initial setting (out of the box, or after a System Reset) causes the radio to ignore weaker (or more distant) signals.

Presetting stations - DAB and FM

You may store your preferred DAB and FM radio stations to the preset station memories. There are 20 memory presets in your radio, 10 for DAB and 10 for FM. Presets are remembered by your radio in the event of a power failure.

The procedure for setting presets and using them to tune stations is the same for FM and DAB modes, and is described below.

1. Press and release the **On / Standby** button to switch on the sound system.
2. Press the **Mode** button to select the desired waveband DAB or FM.
3. Tune to the required station as previously described.
4. Press and hold the **Preset** button. The display will show, for example, '1: (Empty)' if no station has been stored to that preset.
5. Use the **Tuning Up** or **Down** buttons to select the desired preset station number under which you wish to store the station.
6. Press and release the **Preset** button until the display shows, for example, 'Preset 1 stored'. The station will be stored under the chosen preset. Repeat this procedure for the remaining presets.
7. Stations which have been stored in preset memories may be overwritten by following the above procedure.

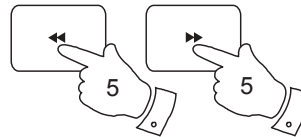
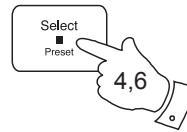
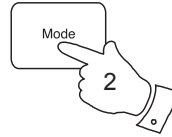
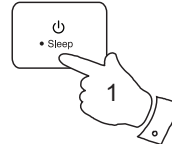

Recalling a preset station

1. Press and release the **On / Standby** button to switch on the sound system.
2. Press the **Mode** button to select the desired waveband DAB or FM.
3. Press and release the **Preset** button. The display will show, for example, '1: (Empty)' if no station has been stored to that preset. If a preset has been stored, then the display will show either the station name (for DAB stations) or the frequency (for FM stations).
4. Press the **Tuning Up** or **Down** buttons to select the desired preset station.
5. Press and release the **Select** button. Your radio will tune to the chosen preset station stored in the preset memory.

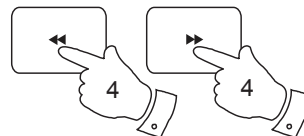
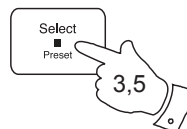
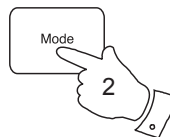

Language function - DAB and FM

If required, your sound system's radio functions can be configured to a different language.

1. Press and release the **On / Standby** button to switch on your sound system.
2. If needed, press the **Mode** button to select the DAB or FM band.
3. Press and hold the **Menu** button. 'DAB or FM Menu' will appear on the display. Press and release the **Select** button to enter the menu.
4. Press the **Tuning Up** or **Down** buttons until 'Language' shows on the display. Press and release the **Select** button to enter the language adjustment menu.
5. Press the **Tuning Up** or **Down** buttons until your desired language appears on the display. The current language setting will be marked with an asterisk.
6. Press and release the **Select** button to confirm your choice. The display will change to the chosen language when using DAB or FM mode.

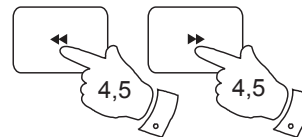
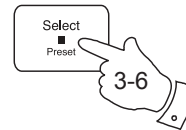
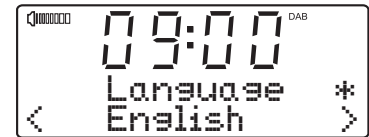
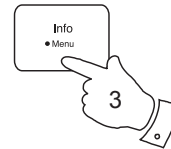
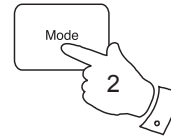
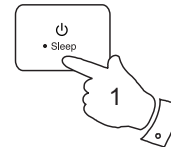

Compact discs

Use only Digital Audio CDs which have the  symbol.

Use only full size CDs (12cm diameter) with the sound system. Mini CDs (8cm diameter) are not compatible with the player and may jam the CD mechanism.

Transparent or partly transparent CDs cannot be played since they may not be detected when inserted. Unusually thin (Eco) CDs cannot be played. Some copy-protected CDs may not be playable.

Never write on a CD or attach any sticker to the CD. Always hold the CD at the edge and store it in its box after use with the label facing up.

To remove dust and dirt, breathe on the CD and wipe it with a soft, lint free cloth in a straight line from the centre towards the edge.

Cleaning agents may damage the CD.

Do not expose the CD to rain, moisture, sand or to excessive heat. (e.g. from heating equipment or in motor cars parked in the sun).

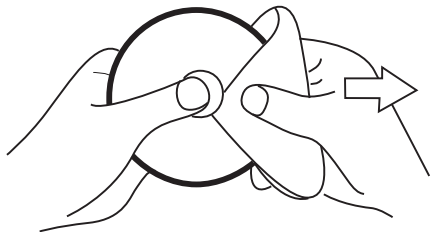

CD-R / CD-RW discs

Your Sound 100 can playback CD-DA format audio CD-R/CD-RW discs that have been finalised* upon completion of recording.

*Finalising enables a CD-R/CD-RW disc to playback on audio players such as your Sound 100. A disc which has not been finalised may have information added to it using a computer but may not always be playable. You may have to specifically enable the finalising step with some CD writing software.

Your Sound 100 may fail to play some CD-R/CD-RW discs due to poor recording and wide variation in quality of the CD-R/CD-RW disc.

Inserting a CD

Ensure the CD player is empty before inserting a disc. If there is a disc in the player then the CD loaded indicator will be lit. If you cannot insert a disc, press the **CD Eject** button to remove the CD currently in the player.

1. Press and release the **On / Standby** button to switch on your sound system.
2. To select the CD mode press the **Mode** button until 'CD' shows on the upper line of the display.
3. To eject a CD press and release the **CD Eject** button. To reload a CD that has just been ejected, press the **Eject** button a second time.
4. Insert a disc with printed side facing up into the CD slot. The disc will be loaded automatically. The unit will check the CD type and load its track list. The display will show 'LOADING' and then 'READING' as the information is read.
5. If you load a disc containing MP3 or WMA files your sound system will enter the MP3 / WMA mode (see page 30).

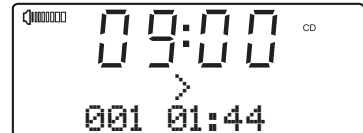
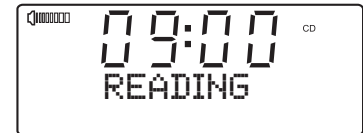
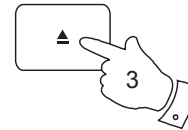
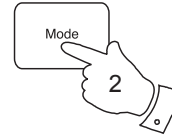
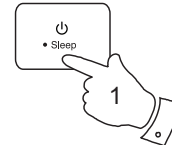

Playing a CD

1. Press the **Play / Pause** button to start playing the disc. The display will show the first track number.
2. Adjust the **Volume** to the required setting.
3. To pause playing press the **Play / Pause** button. To resume press the **Play / Pause** button again.
4. To stop playback, press the **Stop** button.

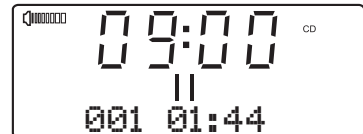
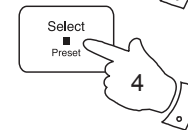
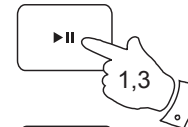

- If you put the unit into standby mode then the next time the unit is switched on it will return to the previously played track.
- To take out the CD, press the **CD Eject** button. The display will show 'EJECT'. In order to protect the disc if it is not removed, the unit will reload the CD after 10 seconds and then enter standby mode.

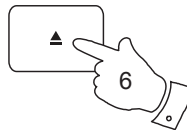

Selecting a track

- While the CD is playing, press either the **Fast-forward** or **Rewind** buttons to change to the desired track. The updated track number is shown in the display.
- You can also skip tracks when the player is paused or stopped. Skip to the desired track using the **Fast-forward** or **Rewind** buttons, release the button when the desired track is displayed.
- Press the **Play / Pause** button to play the selected track.

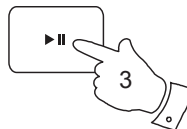
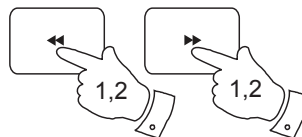

Search function

- While the CD is playing, press and hold the **Fast-forward** or **Rewind** buttons. Release the button when the desired part of the track is reached.

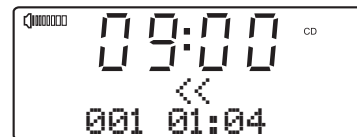
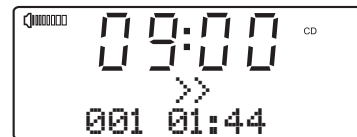
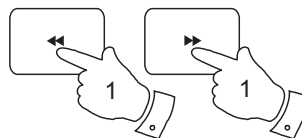

Repeat tracks

1. While the CD is playing, press and hold the **Menu** button.
2. Press the **Tuning Up** or **Down** buttons until 'Repeat' shows on the display. Press the **Select** button to enter the repeat options menu.
3. Press the **Tuning Up** or **Down** buttons until the required repeat option shows on the display and then press the **Select** button to confirm the setting.

- Off - The repeat function will be disabled.
 One (🔁) - The current track (a single track) will be repeated.
 All (ALL) - All tracks on the CD will be played repeatedly.
 Dir (FOLDER) - All tracks in the current folder will be played repeatedly.

Selecting a repeat option will cancel the shuffle setting if previously applied.

Note: The folder repeat option (Dir) is only applicable when using a CD containing MP3 or WMA files (see page 30).

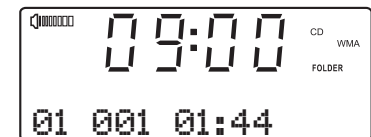
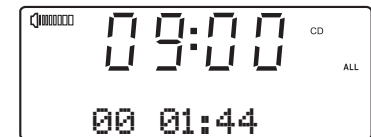
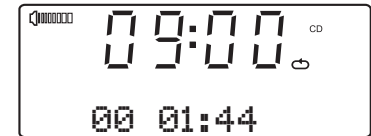
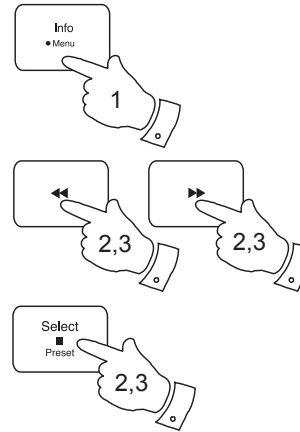

Shuffle tracks

1. While the CD is playing, press and hold the **Menu** button.
2. Press the **Tuning Up** or **Down** buttons until 'Shuffle' shows on the display. Press the **Select** button to enter the shuffle options menu.
3. Press the **Tuning Up** or **Down** buttons until the required shuffle option shows on the display and then press the **Select** button to confirm the setting.

Off - The shuffle function will be disabled.

On - All tracks will be played in random order.

Selecting the shuffle option will cancel any repeat setting if previously applied.

Pressing Stop or ejecting the CD will cancel any repeat or shuffle setting.

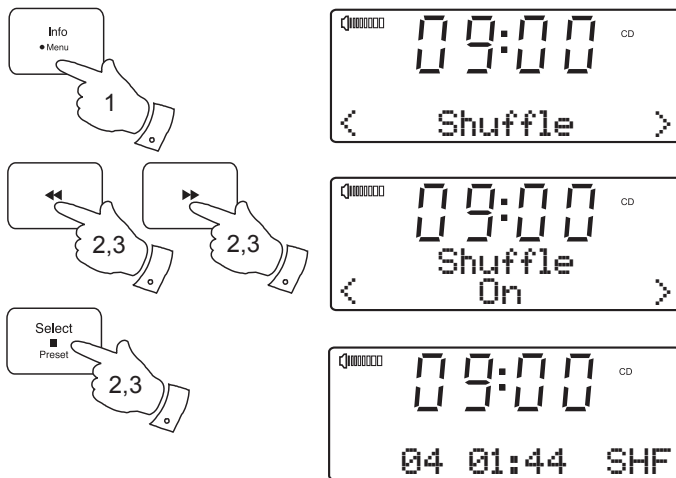

The Sound 100 is able to play CD-R and CD-RW discs containing MP3 and WMA files. It is assumed in this section that a file is equivalent to a CD track.

An MP3 / WMA CD may not contain more than 511 files and not more than 99 folders. MP3 and WMA files should be created with an audio sample rate of 44.1kHz (this is normal for files created from CD audio content). MP3 and WMA data rates up to 320 kilobits per second are supported. WMA Lossless, WMA Voice, WMA 10 Professional and files which have DRM protection are not supported.

When burning CD-R and CD-RW discs with audio files, various problems may arise which could lead to problems with playback. Typically such problems are caused by poor CD writing or audio encoding software, or by the hardware settings of the PC's CD writer, or by the CD being used. Should such problems arise, contact the customer services of your CD writer or software manufacturer or look in their product documentation for relevant information. When you are making audio CDs, take care to observe all legal requirements and ensure that the copyright of third parties is not infringed.

1. To select the CD mode press the **Mode** button until 'CD' shows on the display, or insert a suitably prepared CD-R or CD-RW disc.
2. Insert a CD with printed side facing up into the CD slot. The disc will be loaded automatically. The unit will check the CD type and load its track list. The display will show '*loading*' and then '*reading*' as the information is read.

If there are many files or folders on the CD then it may take some tens of seconds to read all of the file and folder names and to identify those which are playable (with .mp3 or .wma filename extension).

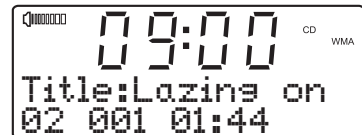
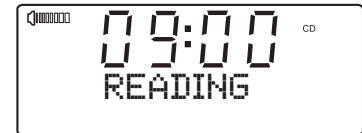
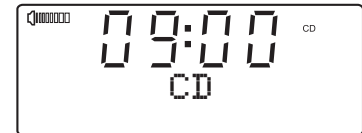
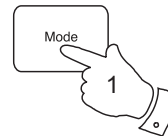

Playing an MP3 / WMA CD

1. Press the **Play/Pause** button to start playing from the CD. The display will show the first folder and file numbers - '01' and '001'.
2. To pause playing press the **Play/Pause** button. To resume playing press the **Play/Pause** button again.

If you put the unit into standby mode then the next time the unit is switched on it will return to the previously played file.

3. To Stop playback, press the **Stop** button.
4. To take out the CD, press the **CD Eject** button. The display will show 'EJECT'. In order to protect the disc if it is not removed, the unit will reload the disc after 10 seconds and then enter standby mode. To reload a CD that has just been ejected, press the **Eject** button a second time.

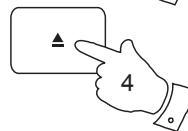
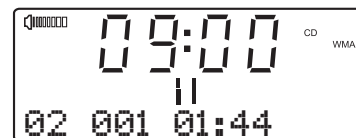
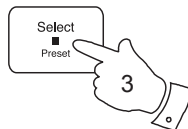
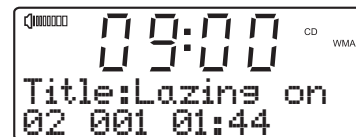
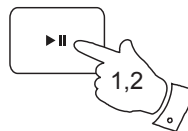

Selecting a file

1. While the CD is playing, press either the **Fast-forward** or **Rewind** buttons to change to the desired file, the file number is updated in the display. If there is more than one folder, when all files in the current folder have been played the next folder will be played.
2. You can also skip files when the player is in stop mode. Skip to the desired file using the **Fast-forward** or **Rewind** buttons and release the button when the desired file number is displayed.
3. Press the **Play/Pause** button to play the selected file.

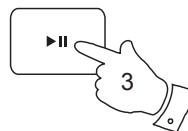
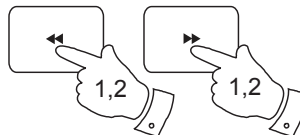

Search function

1. While the MP3 / WMA CD is playing, press and hold the **Fast-forward** or **Rewind buttons**. Release the button when the desired part of the current file is reached.

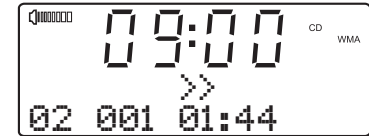
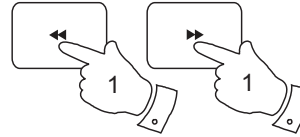

To skip to another folder

1. With the MP3 / WMA CD in stop or play mode, press and release either the **Up** or **Down Folder** buttons. The first file of the next or previous folder will be played.

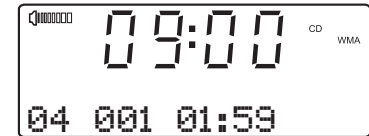
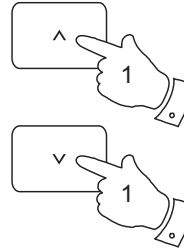

Repeat and shuffle options

The Sound 100 allows you to use the same playback options for files as can be used for conventional CDs (see pages 25-29). In addition to repeat a single file and repeat all options, there is also a repeat folder facility.

iPod® and iPhone® docking

Your sound system has an iPod dock facility which allows you to play digital audio files and video soundtracks held on your iPod or iPhone using the sound system's loudspeakers.

The Sound 100 uses the Universal Dock Connector developed for use with most iPods. Some models of iPod are supplied with Universal Dock Adaptor inserts which ensure correct alignment of the iPod with the electrical connector. Should you require an insert to use your iPod with the Sound 100, then please contact an iPod accessories supplier.

Important: To avoid possible damage to your iPod or iPhone, do not use your iPod or iPhone with the product without the correct adaptor fitted to the sound system.

Throughout this section of this book, iPod means iPod or iPhone.

Docking your iPod

1. Ensure that the sound system is in standby. Carefully remove the iPod dock connector cover from the top of your sound system.
2. Place the iPod docking adaptor (see above) into the iPod docking recess so that it is securely seated.
3. Carefully place your iPod onto the Universal Dock connector.
4. Press and release the **On / Standby** button to switch on your sound system.
5. To select the iPod mode press the **Mode** button until 'iPod' shows on the display. If it was previously playing, your iPod will switch on and continue playing from where it was previously stopped.

Note: The sound system is able to recharge your iPod's internal battery. Your iPod will use its backlight settings as configured. If these need changing, use the iPod's *Settings* menu.

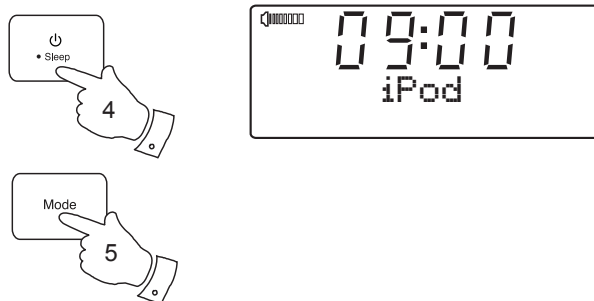
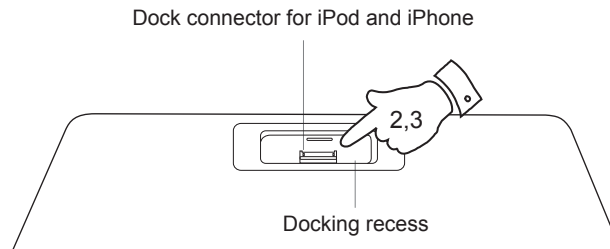

Navigating your iPod

1. Press and release the **Menu** button to navigate to higher level menus on your iPod.
2. Use the **Folder Up** or **Down** buttons as required to move up and down a menu screen on your iPod.
3. Press the **Select** button to choose the highlighted on screen menu item. If this item is a lower level menu item, you may then navigate further using the **Folder Up** or **Down** and **Select** buttons.

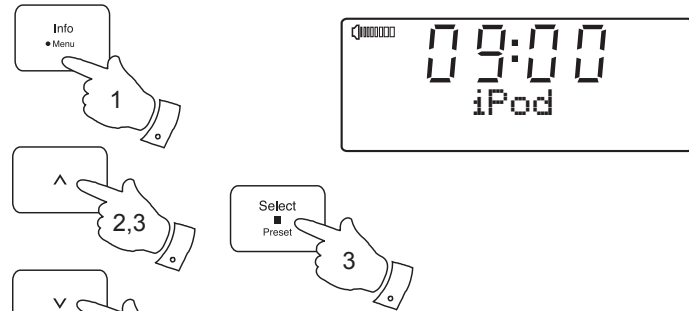

Playing a file on your iPod

1. When you have found the required item use the **Select** button to start the iPod playing.
2. Adjust the volume to the required setting using the **Volume Up** and **Down** buttons on your sound system.
3. To pause playback press the **Play/Pause** button. To resume playback press the **Play/Pause** button again.
4. iPod's do not have a Stop button (they use the Pause function). To play an alternative selection, use the iPod menus to make the selection using the **Play/Pause** button to stop playing the current item if needed.

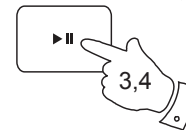
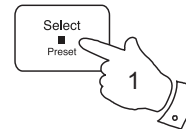
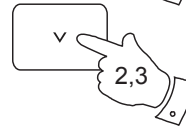

Search function

1. While the iPod is playing, press and hold the **Fast-forward** or **Rewind** buttons. Release the button when the desired part of the item is reached.

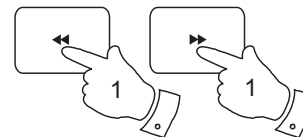

Alarms

Your sound system has two alarms which can each be set to wake you to DAB, FM radio, CD, iPod or buzzer alarm. The alarms may be set while the unit is in standby mode or while playing.

Note: If no buttons are pressed for several seconds, your sound system will exit the alarm setup. To exit the alarm setup at any time press and release the **Menu** button as needed.

1. Before setting an alarm ensure that the clock time is set (see page 40). Press and hold the **Menu** button.
2. Press the **Tuning Up** or **Down** buttons until 'Set alarm' shows on the display. Press and release the **Select** button to enter the alarm setup menu.
3. Press the **Tuning Up** or **Down** buttons to display the required alarm, 1 or 2. Press and release the **Select** button 'Alarm Setting' will show on the display.
4. Press and release the **Select** button to choose alarm setting. 'Alarm: On/Off' will show on the upper line of the text display.
5. Press the **Tuning Up** or **Down** buttons to choose whether to set the alarm to On or Off. If Off is selected, the unit will exit the alarm menu.
6. With 'On' selected on the display, press and release the **Select** button. 'Alarm: Time' will show on the upper line of the text display and the Alarm hour digits will flash.

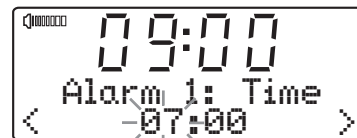
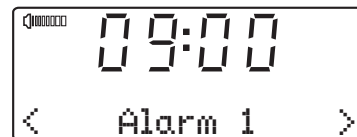
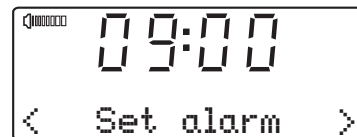
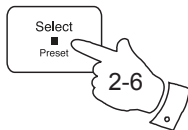
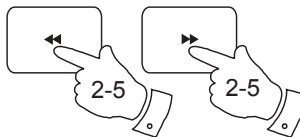
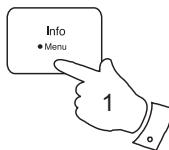

7. Press the **Tuning Up** or **Down** buttons to choose the alarm hour and then press and release the **Select** button to enter the hour setting. The Alarm minute digits will then flash on the display.

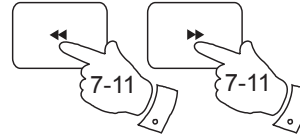

8. Press the **Tuning Up** or **Down** buttons to choose the alarm minute and then press and release the **Select** button to enter the minute setting. 'Alarm: Mode' will show on the upper line of the text display.

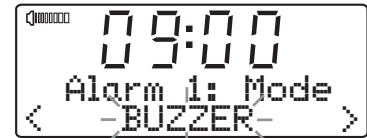
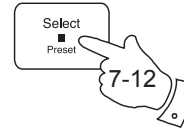

9. Press the **Tuning Up** or **Down** buttons to choose the required alarm mode and then press the **Select** button to confirm the setting.

Each alarm can be set to any of the following modes:

- BUZZER - will wake you with a buzzer alarm
- DAB - will wake you with DAB radio
- FM - will wake you with FM radio
- CD - will wake you playing a CD
- iPod - will wake you playing your iPod



10. Press and release the **Select** button to select the alarm mode. 'Alarm: Day' will show on the upper line of the text display.

11. Press the **Tuning Up** or **Down** buttons to select the required day option on the display.

Your alarm can be set to the following options:

- Once - will sound at one time only
- Daily - will sound everyday
- Weekdays - will sound only on weekdays
- Weekends - will sound only on weekends

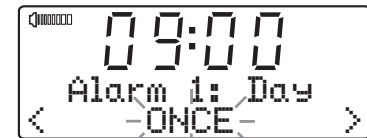

12. Press and release the **Select** button. The alarm volume will flash on the display. The sound system uses the saved volume setting for each alarm when it sounds.

13. Press the **Tuning Up** or **Down** buttons to select the desired alarm volume.

14. Press and release the **Select** button to confirm the alarm settings.
The sound system will exit the alarm menu.

Active alarms are indicated in the display by the  symbol and the corresponding alarm number.

Important: If using your iPod or iPhone as the source for the alarm, then be sure to dock your iPod or iPhone. If the iPod or iPhone is not detected a buzzer alarm will sound instead.

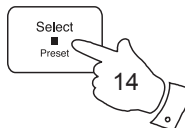
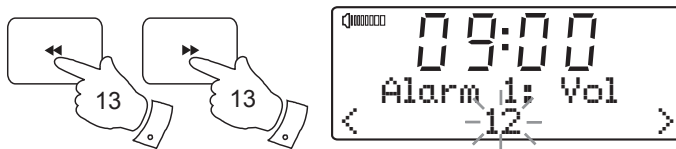

When the alarm sounds

The alarm will sound at the selected times for up to 60 minutes unless cancelled. The volume used for the alarm will be specified during the alarm setting procedure. If the radio cannot connect to the specified radio station, the buzzer will be used instead.

Note: If the radio is switched on because of a radio alarm you can control basic functions such as the volume control.

When the buzzer alarm activates it will start softly and gradually increase in level.

The alarm icon will flash on the screen and the radio will automatically switch back to standby mode when the 60 minutes have elapsed.

To cancel the alarm press and release the **On / Standby** button.

To cancel an alarm at any other time, enter the alarm setup menu and set the alarm On/Off option to 'Off'. See steps 1-5 page 35.

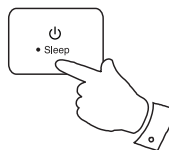

To view the alarm settings

1. Press and hold the **Menu** button.
2. Press the **Tuning Up** or **Down** buttons until 'Set alarm' shows on the display. Press and release the **Select** button to enter alarm setup menu.
3. Press the **Tuning Up** or **Down** buttons to display the required alarm, 1 or 2. Press and release the **Select** button.
4. Press the **Tuning Up** or **Down** buttons until 'View' shows on the display.
5. Press and release the **Select** button to cycle through each of the settings for the chosen alarm.

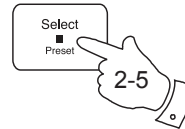
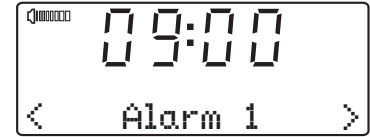
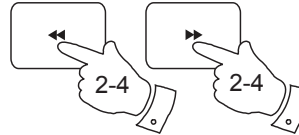
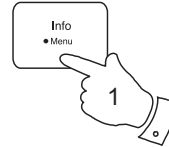

Snooze function

1. When the radio, iPod, CD or buzzer alarm sounds, pressing **any button** other than the On / Standby or Volume buttons will silence the alarm for 5 minutes. The Snooze symbol (SNOOZE) will flash. This sequence can be repeated during the 60 minute alarm period.
2. To cancel the Snooze function, press the **On / Standby** button.

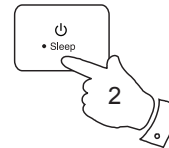

Sleep function

Your sound system can be set to turn off after a preset time has elapsed. The sleep setting can be adjusted between 15 and 120 minutes. Ensure your sound system is switched On.

1. When using your sound system, press and hold the **Sleep** button. 'Sleep time' appears on the display.
2. Press the **Tuning Up** or **Down** buttons to select the desired sleep time. The options are 15, 30, 60, 90 or 120 minutes. A further press will cause the sleep timer to be set to Off which will cancel the sleep function.
3. Press and release the **Select** button. The display will exit the sleep options. The sleep symbol ☹ will show on the display.
4. Your sound system will switch off after the preset sleep time has elapsed.
5. To cancel the sleep timer and switch off your sound system before the chosen sleep time has elapsed, press and release the **On / Standby** button.
To cancel the sleep timer without switching off your sound system, set the sleep timer to 'Off' in step 2 above.
6. When the sleep time has been set you may view the remaining sleep time. Press and hold the **Sleep** button. The remaining sleep time will show on the display.

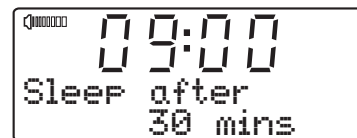
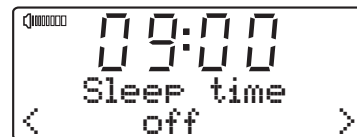
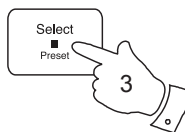
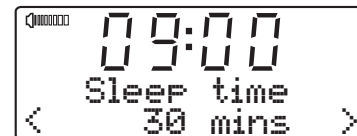
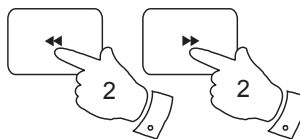
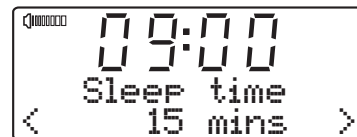
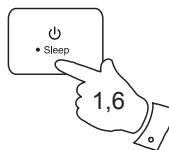

Setting the clock manually

Normally your sound system will set its clock automatically using the DAB radio signal. If no DAB signal is available and you need to set the time manually, please follow the procedure shown below. The clock may be set while the unit is in standby mode or while playing.

1. To set the clock time, press and hold the **Menu** button.
2. Press the **Tuning Up** or **Down** buttons until 'Set clock' appears on the display. Press and release the **Select** button.
3. Press the **Tuning Up** or **Down** buttons until 'Manual' appears on the display.
4. Press and release the **Select** button. The hour digits will then flash on the display.
5. Press the **Tuning Up** or **Down** buttons to set the desired hour.
6. Press and release the **Select** button to enter the hour setting. The minute digits will then flash on the display.
7. Press the **Tuning Up** or **Down** buttons to set the desired minute.
8. Press and release the **Select** button. The year will then flash on the display.

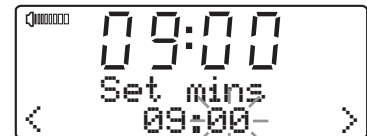
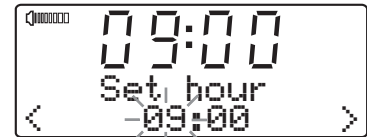
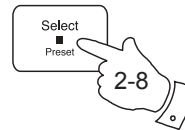
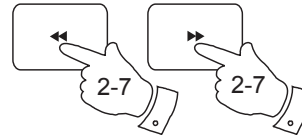
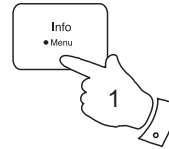

9. Press the **Tuning Up** or **Down** buttons to select the current year.
10. Press and release the **Select** button to enter the year setting. The month will then flash on the display.
11. Press the **Tuning Up** or **Down** buttons to set the current month.
12. Press and release the **Select** button to enter the month setting. The day will then flash on the display.
13. Press the **Tuning Up** or **Down** buttons to change the day as needed.
14. Press and release the **Select** button to confirm the clock setting. The sound system will exit the menu.

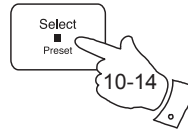
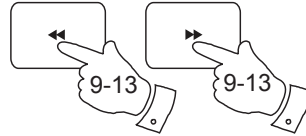

To return to auto clock set mode

The auto clock set mode may be set while the unit is in standby or while playing.

1. Press and hold the **Menu** button.
2. Press the **Tuning Up** or **Down** buttons until 'Set clock' appears on the display. Press and release the **Select** button.
3. Press the **Tuning Up** or **Down** buttons until 'Auto' appears on the display. Press and release the **Select** button.
4. The sound system will set its time according to the information received with the DAB broadcast when the radio is tuned to a DAB station.

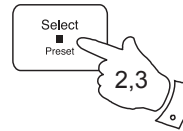
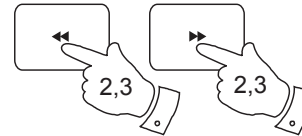
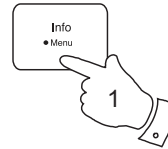

Standby brightness control

The brightness of the display when the unit is in standby mode may be adjusted. If you use the unit in the bedroom, you may prefer a lower standby brightness level than the standard setting.

The standby brightness level may be set while the unit is in standby or while it is playing.

1. Press and hold the **Menu** button.
2. Press the **Tuning Up** or **Down** buttons until the display shows 'Set Brightness' on the lower line of the text display.
3. Press and release the **Select** button to show the current setting.
4. Press the **Tuning Up** or **Down** buttons to change the standby brightness level. The backlight level will change at the same time so that you can see the effect of the change when the unit is in standby mode.
5. Press and release the **Select** button to save the new setting.

The default setting after a system reset is 5. Possible brightness values range from 1 - 7.

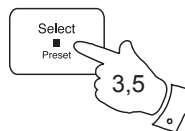
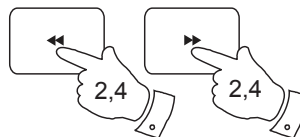
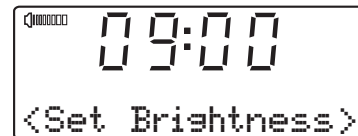
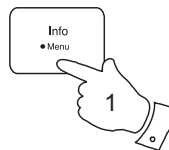

Equalizer function

The sound on your sound system can be adjusted to suit your personal taste for the material that you are listening to. The Sound 100 has six preset equalizer options. Alternatively, you may set the treble and bass levels to your own preferences.

1. Press and release the **On / Standby** button to switch on the sound system.
2. Press and hold the **Menu** button.
3. Press the **Tuning Up** or **Down** buttons until 'Set Equalizer' appears on the display.
4. Press and release the **Select** button to enter the equalizer menu.
5. Press the **Tuning Up** or **Down** buttons to cycle through the various options until the desired option is displayed. Press and release the **Select** button to confirm your choice.
 - a. Flat - no tone modification is applied
 - b. Jazz
 - c. Rock
 - d. Classic
 - e. Pop
 - f. News
- For details on setting the treble and bass settings, please see overleaf.

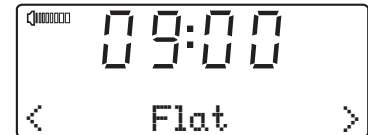
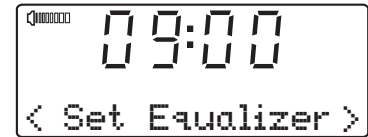
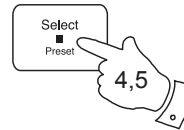
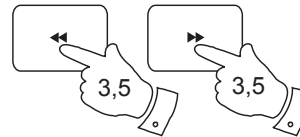
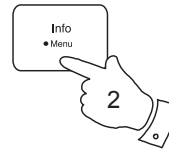

Treble control

1. Follow steps 1-4 on the preceding page to enter the Equalizer setup menu.
2. Press the **Tuning Up** or **Down** buttons to cycle through the options until 'Treble' appears on the display.
3. Press and release the **Select** button. The current treble setting will be displayed.
4. To adjust the treble setting press the **Tuning Up** or **Down** buttons until the desired level is displayed.
5. Press and release the **Select** button to confirm the setting.

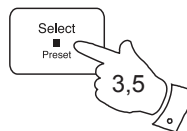
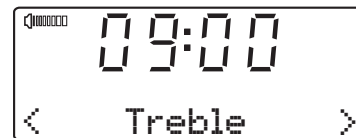
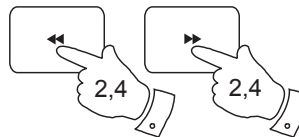

Bass control

1. Follow steps 1-4 on the preceding page to enter the Equalizer setup menu.
2. Press the **Tuning Up** or **Down** buttons to cycle through the options until 'Bass' appears on the display.
3. Press and release the **Select** button. The current Bass setting will be displayed.
4. To adjust the Bass setting press the **Tuning Up** or **Down** buttons until the desired level is displayed.
5. Press and release the **Select** button to confirm the setting.

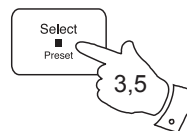
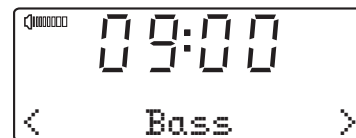
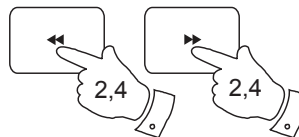

Mute function

When playing in DAB, FM radio or Auxiliary input mode, the Play / Pause button has a mute function. Pressing the Play / Pause button will mute the output from the loudspeakers.

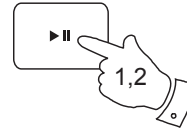

1. Press and release the **Play / Pause** button to mute the sound output. The speaker volume symbol on the display will disappear.
 2. Press and release the **Play / Pause** button again or one of the **Volume** buttons to un-mute the sound output.
-

USB socket for software upgrade

In the event that any software update is made available for your sound system, information on how to update your sound system will be made available via our website at <http://www.robertsradio.co.uk>

Software version displays

The sound system has the means to display the version numbers of the different software components that allow it to function. These displays are provided for reference in case they are needed for service or customer support.

To display the system software version...

1. Press and hold the **Menu** button.
2. Press the **Tuning Up** or **Down** buttons until the display shows the software version information for a few seconds.

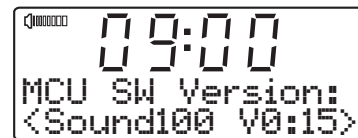
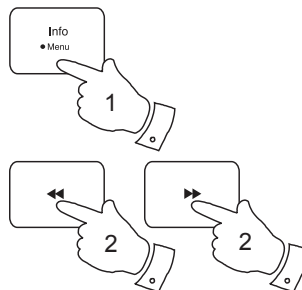

To display the DAB/FM radio software version...

1. In DAB mode press and hold the **Menu** button. 'DAB Menu' will appear on the display. Press and release the **Select** button to enter the DAB menu.
2. Press the **Tuning Up** or **Down** buttons until the display shows the software version information for a few seconds.

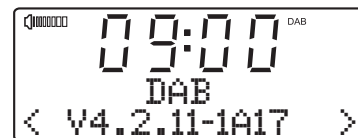
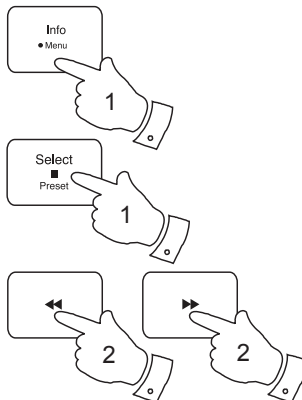

To display the CD/MP3/WMA software version...

1. In CD mode with no CD inserted press and hold the **Mode** button.
2. The display shows the software version information for a few seconds.

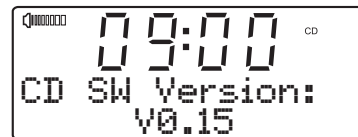
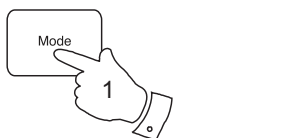

System reset

If your sound system fails to operate correctly, or some digits on the display are missing or incomplete carry out the following procedure.

1. Press and hold the **Menu** button.
2. Press the **Tuning Up** or **Down** buttons until the display shows 'System reset'.
3. Press and release the **Select** button. The display will show 'Press SELECT to reset'.
4. Press and release the **Select** button again to confirm the reset operation.
5. A full reset will be performed. The station list and presets will be erased. Alarms will be cancelled, audio equaliser and display brightness settings will have been set to their default values. The clock will be reset and the unit will behave as when first switched on (see page 9).

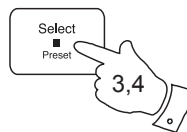
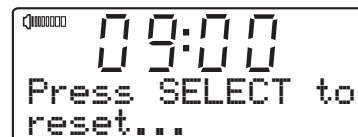
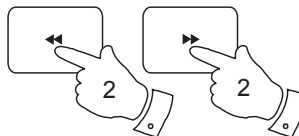
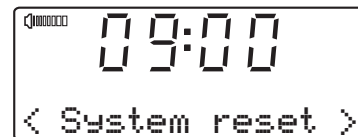
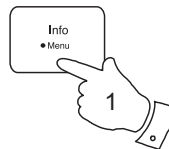

In case of malfunction due to electrostatic discharge, reset the product using the above procedure. In some circumstances it may be necessary to disconnect and then reconnect the mains power in order to resume normal operation.

If a problem persists our technical staff would be pleased to help offer any assistance on operating the radio. Our technical helpline number is 020 8758 0338.

Headphone socket

A 3.5mm stereo **Headphone Socket** is provided on the rear of your sound system for use with headphones. Inserting a plug automatically mutes the internal loudspeakers.

Please be aware that the sensitivity of headphones can vary widely. We therefore recommend setting the volume to a low level before connecting headphones to the sound system.

IMPORTANT: Excessive sound pressure from earphones and headphones can cause hearing loss.

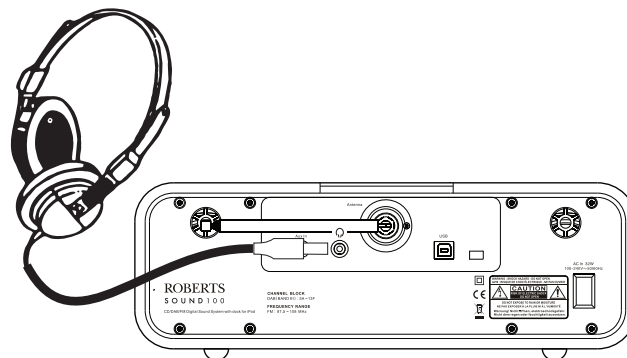

Aerial removal

The fitted telescopic aerial is suitable for most applications. In some locations if reception conditions are poor, an external antenna may be more suitable. For this purpose the telescopic aerial may be removed to allow connection to an external aerial using a coaxial cable.

First remove the two small screws holding the antenna connector cover in place using a small cross-head screw driver. Then using a suitable spanner (11mm across the flats), remove the telescopic aerial by rotating in an anti-clockwise direction when viewed from the rear of the product.

This will expose an F-type connector to which a coaxial cable may then be connected.

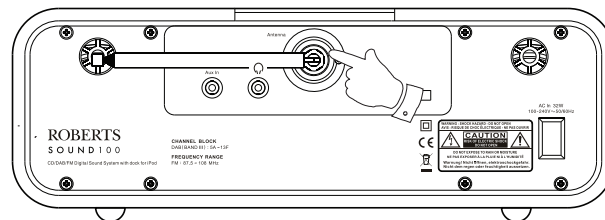

Auxiliary input socket

A 3.5mm stereo **Auxiliary Input socket** is provided on the rear of your sound system to permit an audio signal to be fed into the unit from an external audio device such as iPod, MP3 or CD player.

1. Press and release the **Mode** button until "AUX IN" is displayed.
2. Connect an external audio source (for example, iPod, MP3 or CD player) to the **Auxiliary input socket**.
3. Adjust the volume setting on your iPod, MP3 or CD player if necessary to ensure an adequate signal level, and then use the **Volume Up** or **Down** buttons on the sound system as needed for comfortable listening.

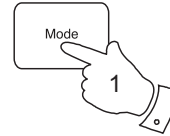
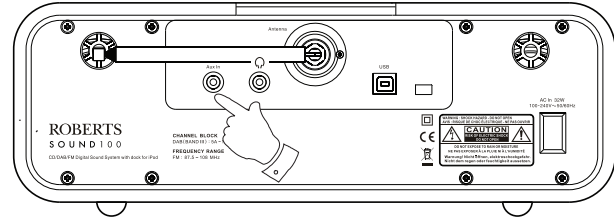

Cautions

Do not allow this sound system to be exposed to water, steam or sand. Do not leave your sound system where excessive heat could cause damage.

It is recommended that the DAB band is used for radio listening where possible since this may result in better sound quality and freedom from interference than will often be obtained on the FM band.

The name plate is located on the rear of your sound system.



- The sound system shall not be exposed to dripping or splashing and that no objects filled with liquids, such as vases, shall be placed on the sound system.
- It is recommended to operate the product such that there is a minimum distance (10cm recommended) to adjacent objects in order to ensure good ventilation.
- The ventilation of the product should not be restricted by covering it or its ventilation openings with items such as newspapers, tablecloths, curtains etc.
- No naked flame sources such as lighted candles should be placed on the product.
- It is recommended to avoid using or storing the product at extremes of temperature. Avoid leaving the unit in cars, on window sills, in direct sunlight etc.

Specifications

Power Requirements

| | |
|--------------------------|--------------------------------|
| Mains | AC 230 volts, 50Hz \sim only |
| Battery (Remote control) | 1 x CR2032 |

Frequency Coverage

| | |
|-----|----------------------|
| FM | 87.5-108MHz |
| DAB | 174.928 - 239.200MHz |

Circuit features

| | | |
|---------------------|-------------|-------------------|
| Output Power | 2 x 7 watts | |
| Headphone socket | 3.5mm dia | |
| Auxiliary in socket | 3.5mm dia | |
| Aerial System | FM | Telescopic aerial |
| | DAB | Telescopic aerial |

The Company reserves the right to amend the specification without notice.

Mains supply

The Sound 100 will operate from a supply of AC 230 volts, 50Hz \sim only.

DO NOT cut off the mains plug from this equipment. If the plug fitted is not suitable for the power points in your home or the cable is too short to reach a power point, then obtain an appropriate safety approved extension lead or adaptor. If in doubt consult your dealer.

If nonetheless the mains plug is cut off, remove the fuse and dispose of the plug immediately to avoid a possible shock hazard by inadvertent connection to the mains supply.

If this product is not supplied with a mains plug, or one has to be fitted, then follow the instructions given below:

IMPORTANT. DO NOT make any connection to the larger terminal which is marked with the letter E or by the safety earth symbol \perp or coloured Green or Green-and-yellow.

The wires in the mains lead are coloured in accordance with the following codes :-

BLUE - NEUTRAL

BROWN - LIVE

The wire coloured BLUE must be connected to the terminal marked N or coloured BLACK.

The wire coloured BROWN must be connected to the terminal marked L or coloured RED.

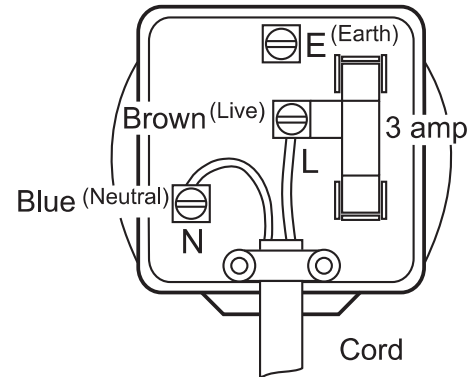

Fuse

When replacing the fuse only a 3A ASTA approved to BS1362 type should be used and be sure to re-fit the fuse cover.

IF IN DOUBT - CONSULT A QUALIFIED ELECTRICIAN.

Replacement fuse holders are available from Roberts Radio Technical Services at the address shown on the rear of this manual.

iPhone and iPod are trademarks of Apple Inc., registered in the U.S. and other countries.

"Made for iPod" and "Made for iPhone" mean that an electronic accessory has been designed to connect specifically to iPod or iPhone respectively, and has been certified by the developer to meet Apple performance standards.

Apple is not responsible for the operation of this device or its compliance with safety and regulatory standards. Please note that the use of this accessory with iPod or iPhone may affect wireless performance.

This instrument is guaranteed for twelve months from the date of delivery to the original owner against failure due to faulty workmanship or component breakdown, subject to the procedure stated below. Should any component or part fail during this guarantee period it will be repaired or replaced free of charge.

The guarantee does not cover:

1. Damage resulting from incorrect use.
2. Consequential damage.
3. Receivers with removed or defaced serial numbers.

N.B. Damaged or broken telescopic aerials will not be replaced under guarantee.

Procedure:

Any claim under this guarantee should be made through the dealer from whom the instrument was purchased. It is likely that your Roberts' dealer will be able to attend to any defect quickly and efficiently but should it be necessary the dealer will return the instrument to the Company's service department for attention. In the event that it is not possible to return the instrument to the Roberts' dealer from whom it was purchased, please contact Roberts Radio Technical Services at the address shown overleaf.

These statements do not affect the statutory rights of a consumer.

ROBERTS RADIO TECHNICAL SERVICES

97-99 Worton Road

Isleworth

Middlesex

TW7 6EG

Technical Helpline :- 020 8758 0338 (Mon-Fri during office hours)

Website: <http://www.robertsradio.co.uk>

