

Roberts

Rambler Max

Smart Radio with Internet radio / DAB+ / FM / Bluetooth / USB and Streaming Services
and remote control from iPhone and Android using Oktiv



Please read this manual before use



Contents

Rambler Max Smart Radio features	2	Bluetooth mode	32
Before you can use this product	3	Connecting Bluetooth devices	32
About this instruction manual	4	Playing audio files in Bluetooth mode	33
Controls and connections	5	Connecting a different Bluetooth device	33
Navigation controls	7	Disconnecting a Bluetooth device	34
Text entry	7	Clear Bluetooth Pairings	34
Configuration	9	Additional Bluetooth connection options	34
Plugging in and language selection	9	Bluetooth information	35
Clock and time settings	10	Clock and Alarms	36
Connecting to your computer network	11	Automatically updating the clock	36
Keep network connected	11	Manually setting the clock	37
Changing the network connection	15	Setting the alarm clock	38
Manual network configuration	16	Snooze timer	40
Internet Radio	17	Disabling alarms	40
Internet Radio - the basics	17	Sleep timer	41
Selecting a radio station by location and genre	18	Display and Audio	42
Searching for a radio station by name	18	Equaliser function	42
Selecting a Popular station / Discover new stations	19	Brightness control	43
Selecting a Podcast	19	Headphone socket	44
Last Listened	19	Auxiliary input socket	44
Presetting stations Internet radio, DAB and FM	20	Inactive Standby feature	45
Display options - Radio / Bluetooth / USB	21	USB socket for smartphone or tablet charging	45
Using USB memory devices	22	Information	46
Playing files from USB memory devices	23	Using the Oktiv app	46
Playlists	24	Using the BP3 rechargeable battery pack accessory	47
Repeat and Shuffle play options	26	Factory reset	48
DAB Radio	27	Electro-magnetic compatibility advice	48
Selecting a DAB radio station	27	Product markings	48
Finding new DAB radio stations	28	Software update	49
FM Radio	30	Troubleshooting	51
Manual tuning	30	Cautions	53
Scan sensitivity setting - FM	31	Specifications	54
		Guarantee	57



Rambler Max Smart Radio features

The Roberts Rambler Max Smart Radio provides the following features in an attractive compact unit:-

- Listen to local, regional, national and international broadcasts using FM, DAB and Internet radio.
- Listen to thousands of radio stations from around the world and listen to podcasts from a wide range of broadcasters.
- 60 radio station presets (20 Internet Radio / Podcasts, 20 DAB and 20 FM).
- Playback of MP3 audio files from USB memory devices.
- The Rambler Max connects to your home network using a WiFi connection. Dual band WiFi allows compatibility with a wide range of networks.
- WiFi Protected Setup (WPS) is supported for simpler setting up with compatible broadband routers.
- All radio station presets, network configuration details and user settings are retained in the event of a power failure.
- Spotify Connect allows your Spotify selections to be played through the radio, remotely controlled from your iPhone, iPad, Android device or any Desktop.
- Supports remote control from smart phones and tablets using the Oktiv app.
- Bluetooth streaming to play your music or video soundtracks from your smartphone, tablet or similar device.
- Large clock display with time and date when in standby.
- Two alarm timers with snooze feature to wake you to either a buzzer or a radio alarm.
- Adjustable sleep timer, can be set to turn the radio off after a delay.
- Menu display in a choice of languages - Danish, Dutch, English, French, German, Italian, Norwegian.
- Power saving Inactive Standby.
- Easy-to-read colour graphic display with an adjustable display backlight.
- Auxiliary input for playing audio from MP3 players, iPods or other audio equipment.
- Mains or battery powered using supplied mains adaptor or the Roberts BP3 rechargeable battery pack (available separately).



Before you can use this product

Before you can use your radio, you must have the following:

- A broadband Internet connection (not required for DAB, FM or Music Player functions).
- A router providing a WiFi signal, connected to your broadband Internet service.
- To use remote control features in the Oktiv app you will need a smart phone or tablet which uses either the Android operating system (version 8.0 or later) or Apple iOS (version 13.0 or later).
- If your WiFi network requires a security password to allow connection, then you either need to know the password used for encryption so that you can get the radio to communicate with the network, or your router needs to offer WiFi Protected Setup (WPS).

The radio's WiFi system is compatible with 802.11b, g, n or a networks and can use 2.4 GHz or 5 GHz WiFi frequency bands.

The radio will typically work within a 10-20 metre radius from your broadband router. The actual range achieved will depend upon the building type, other nearby WiFi networks, and possible interference sources. DAB and FM radio functions can operate wherever the radio is able to receive a suitable broadcast signal.

You will first need to connect your radio to your WiFi network see [Configuration, page 9 onwards](#).

Once connected, your smart radio will check for any software updates.

[Details on updating your smart radio can be found on page 49.](#)

IMPORTANT: Before you continue, make sure that your router is powered up and working with your broadband Internet service (use your computer, smart-phone or tablet to verify this). To get this part of the system working you must refer to the instructions supplied with those items.



About this instruction manual

This instruction manual is split into sections for each of the operating modes of your Roberts Rambler Max smart radio. Each section is clearly identified by the shaded heading in the top right hand corner of each pair of pages.

Before using the Internet Radio, you will need to connect your radio to your broadband using the WiFi connection. This is covered in the section titled **Configuration**. This section also explains how to set the menu language option.

The **Internet Radio** section describes how to find radio stations to listen to. These can be radio stations that you already know and listen to conventionally, or new stations you may search for.

The section for the **USB** describes how you may play music files that you have stored on a USB memory device.

The two sections for **DAB** and **FM Radio** describe how to use the radio to listen to conventional radio broadcasts.

The **Bluetooth** section describes how to use your Rambler Max to play audio files or video soundtracks directly from your smartphone, tablet or similar devices.

The section titled **Clock** and **Alarms** describes the different ways by which the clock in the radio may be set, as well as explaining the use of the alarms, snooze and sleep timer features.

The **Display** and **Audio** section shows how to adjust the display, use the equaliser and connect your radio to other audio equipment.

The **Information** section includes downloading Oktiv, using the optional battery pack, troubleshooting, specifications and warranty information.

The buttons on each page (as below) and the coloured page references (as above right) in this manual allow you to jump quickly to a particular section when viewing using a tablet, phone or PC. If this does not work, it may be that the PDF viewer on your device does not support this feature.



Configuration

[\(page 9\)](#)

Internet Radio

[\(page 17\)](#)

USB

[\(page 22\)](#)

DAB & FM Radio

[\(page 27\)](#)

Bluetooth

[\(page 32\)](#)

Clock and Alarms

[\(page 36\)](#)

Display & Audio

[\(page 42\)](#)

Information

[\(page 46\)](#)

Controls and connections

Top view

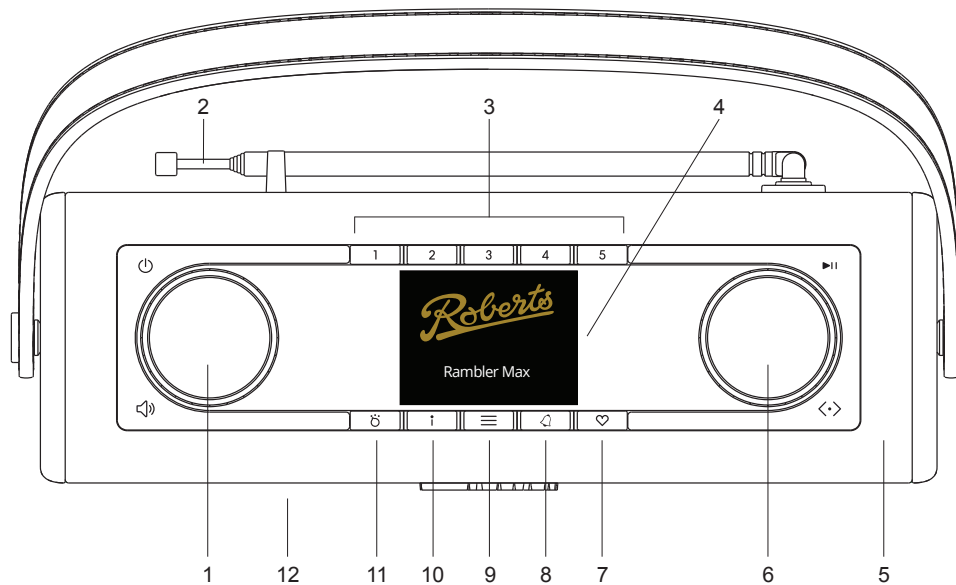

1. Volume / On / Standby control

2. Telescopic aerial

3. Preset buttons 1 - 5

4. LCD display

5. WiFi antenna (internal)

6. Tuning / Select / Snooze control

7. Recall / Store Presets button

8. Alarm / Sleep button

9. Menu button

10. Info button

11. Mode button

12. Loudspeaker



Bottom view

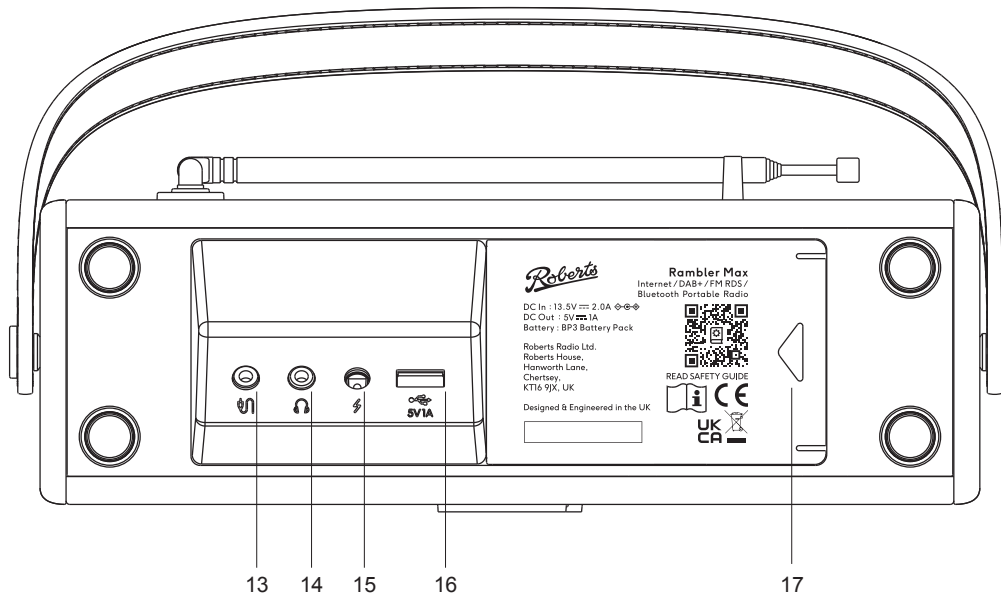

- 13. Auxiliary Input socket
- 14. Headphone socket
- 15. DC Input socket
- 16. USB socket
- 17. Rechargeable Battery compartment



Navigation controls

This page describes the basic means of controlling your Rambler Max radio. Instructions for each operating mode are given in the later sections of this book.

1. Pressing and releasing the **On/Off** control brings your radio out of Standby mode if running from the mains or switches it on if using the rechargeable battery. Pressing and releasing the **On/Off** control while the radio is in use will cause it to return to the Standby mode with the clock display when running from the mains, or will switch it off after a short delay when running from the battery.
2. Pressing the **Mode** button gives you access to each of the operating modes in turn. Alternatively press the **Mode** button and then turn the **Tuning/Select** control clockwise or anti-clockwise to highlight the desired mode and then press the control to select that option. The Audio Equaliser function is also available from here.
3. Pressing the **Menu** button will access the menu system.
4. Many operations require the user to make a selection from the menu. This is done using the **Tuning/Select** control. Turn the control clockwise or anti-clockwise to highlight the desired menu item then press the control to select that item.

If there are more than six items in a menu, then the display will automatically scroll up or down so that the additional items become visible. A sliding bar on the right gives an indication showing the current portion of the menu that is displayed. If there are many items in a menu, then the radio allows the menu to 'wrap around' in either direction. This can make it easier to reach items at the end of a long menu, such as a list of countries or Internet radio stations.
5. If an error is made when navigating the menus, it is generally possible to go back to a higher level menu by pressing the **Menu** button.
6. The **Info** button allows the display of information relating to the radio station or music file being played.

Note: In this booklet, press always means **press and release**. If it is required to give a long press on a button this will be described as **apply a long press** and the button should be held down for 2 to 3 seconds until the radio has responded.

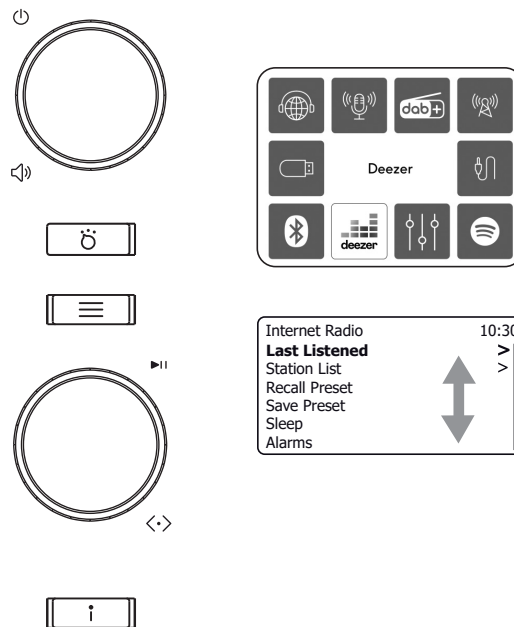

Navigation controls cont.

Text entry

There are several occasions when you may need to enter text characters into your radio. For example, when setting up the WiFi connection, or when searching for particular radio stations. Text is entered using the **Tuning/Select** control. The rotary control allows you to choose from all of the available characters.

1. Rotate the **Tuning/Select** control to highlight each character as needed and press the control to enter each character into the radio.
2. The **Info** button allows quick access to the Backspace control. You can then use the **Tuning/Select** control to access the OK and Cancel options. Press **Info** again to go back to the character selection.

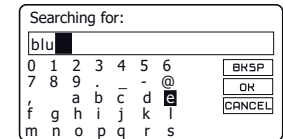
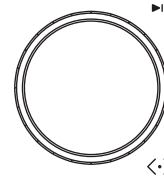

Configuration

Plugging in and language selection

Your radio may be configured using either the display and buttons on the radio, or by using the Oktiv app.

1. Plug the cable from the mains adaptor into the **DC input socket** located underneath your radio (marked ) ensuring that the plug is pushed fully into the socket and place your radio on a flat surface.

2. Plug the mains adaptor into a wall socket and switch on the socket.

IMPORTANT: The mains adaptor is used as the means of connecting the radio to the mains supply. The mains socket and any multi-way mains block used for the radio must remain accessible during normal use. In order to disconnect the radio from the mains, the mains adaptor should be removed from the mains socket outlet completely.

3. When you apply power, the display on the radio will light up and show a start up screen for a few seconds. If this is the first time that you use your radio (or after a Factory Reset) the display will then show the language menu.

4. By default your radio will display all menus and messages in English. Rotate **Tuning** to highlight the desired language. Press **Tuning** to enter the selection. Your radio will display a privacy policy. Please read the privacy policy and then press the **Tuning** control to accept the policy. The radio will then show 'Setup Wizard' and 'YES' will be highlighted on the screen.

5. Press **Tuning** to select 'YES' and to begin setting up your radio

Continue on the next page.

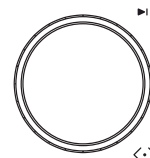
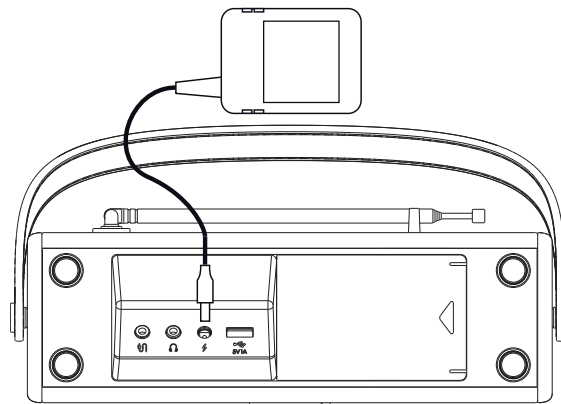

Clock and time settings

The following instructions assume that you have just plugged in your radio and you have just specified the language option for the menus ([see page 9](#)).

1. Rotate **Tuning** to highlight the desired clock format (either 12 or 24 hour) then press the control to enter your selection.
2. Next, the way in which the radio updates its clock is set. A menu allowing you to specify the auto-update option for the clock will be shown. The 'Update from Network' option will be best for most users.
3. Rotate **Tuning** to choose an auto-update option for the clock. This can be updated from DAB or FM radio, from the Network, or not updated automatically. The default is to auto-update from the network. If you choose a different option go to '[Connecting to your computer network](#)' on page 11. Otherwise you will first need to select the correct time zone and daylight savings setting, see the next steps. If you choose 'No update' you will later need to set the [clock manually](#), see page 37. Press the control to confirm your choice.
4. Rotate **Tuning** to highlight the correct time zone for your current location. Press **Tuning** to enter the setting.
5. You will then need to set the Daylight Savings option according to your location (Daylight Savings is also known as Summer/Winter time or BST/ GMT adjustment).
 Rotate **Tuning** to highlight 'ON' or 'OFF' as required. The asterisk shows the current setting.
 For the UK, 'ON' is equivalent to British Summer Time and 'OFF' is equivalent to Greenwich Mean Time.
6. Continue setting up your radio on the next page.

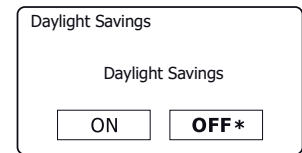
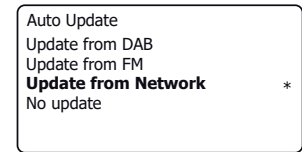
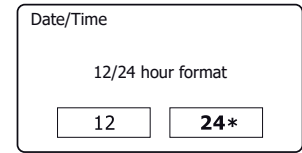
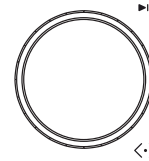

Connecting to your computer network

Before you can use your Rambler Max to listen to Internet radio or to any music streaming services, it must first be connected to your WiFi network. This section describes how to do this.

The following instructions assume that you have set up the clock and time options using the Setup Wizard as described on the preceding page. These instructions also apply to the Network Wizard in the Network Settings menu (from step 2 onwards).

Keep network connected

You can choose whether your radio will keep its connection to WiFi available when it is in standby through the menu option *'Keep Network Connected'*. In the Standby mode display the WiFi signal indicator is shown with or without a cross through it, according to the state of the connection.

1. After setting the [Daylight Savings options \(see page 10\)](#), the display will show the *'Keep network connected?'* option. You should choose 'Yes' if you wish to keep the radio connected to the network when it is in Standby mode. This will allow your radio to be controlled using an app on a phone or tablet when needed.

If you choose 'No' then your radio will shut down its WiFi connection when it is in Standby, DAB, FM, Bluetooth or Aux-in modes. This slightly reduces power consumption but it does mean that you will need to switch the radio on manually in order to use it with either Spotify Connect or the Oktiv app.

Rotate **Tuning** to highlight the required option and then press the control to make the selection.

Your radio will then scan for available WiFi networks.

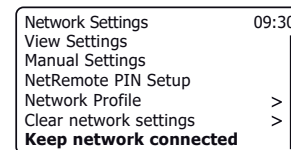
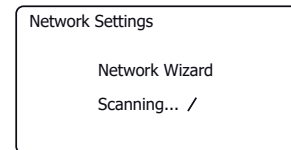
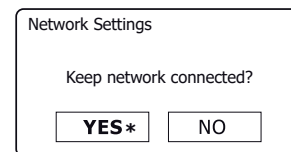

Connecting to your computer network - cont.

- The radio will enter the Network Settings Wizard and will display 'Scanning...'. The radio will automatically scan both 2.4GHz and 5GHz WiFi bands. After a short while the display will show a list of the available WiFi networks.
- You will first need to identify your network in the list of network names presented by the Network Wizard. If no networks are found then you may have to get your broadband router working (please see the instructions supplied with it) or you may be too far from the router.

When the radio finds your WiFi network, it displays the Network Name (SSID) for the network on the screen. This is a name that is allocated to the WiFi from your router by the person who set up the network - for example: 'Jones family' or 'Paul's network'.

Routers supplied by Internet Service Providers often have the default name of the WiFi network provided on a label or card for easy reference (e.g. BTHub-1234, VM1234567).

If the router supports WiFi Protected Setup, then '[WPS]' will be shown in front of the SSID.

It is quite likely that your radio will find more than one WiFi network, in which case you should choose your network from the list.

- Rotate **Tuning** to see the SSID for each WiFi network that has been found. If your network is shown proceed to step 6 on the next page. If it is *not* shown then proceed to step 5, also on the next page.

If you make a mistake at any point, use the **Menu** button to go back to the previous screen.

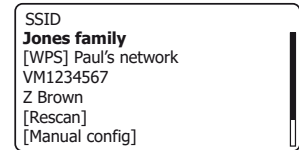
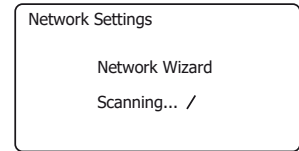
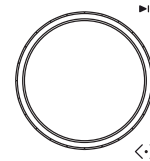

Connecting to your computer network - cont.

5. If your network is not found, it may be because the router is configured not to broadcast the SSID. You should then use the **Tuning** control to highlight and select the *'[Manual config]'* option in order to enter the network details manually. This is described in ['Manual Network Configuration', see page 16.](#)

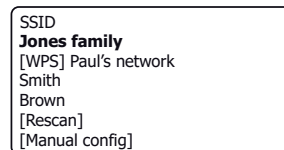

If your network name is being broadcast but it was not found, then try re-scanning (press the **Menu** button), and if necessary try moving your radio to a location closer to your router.

6. When the SSID for the WiFi network you wish to connect to is highlighted on the screen, press the **Tuning/Select** control. If WiFi Protected Setup (WPS) was indicated, you will see an additional menu at this point, otherwise proceed to step 7.

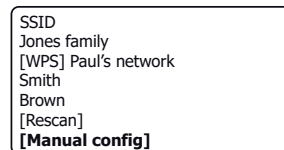

Choose one of the WPS menu options as required for your router (WPS may be via push button, or using an identification number).

'Push Button' - the display prompts you to press the WPS button on your router and then the **Tuning/Select** control on the radio. The two devices should then connect with the encryption key sent automatically to the radio.

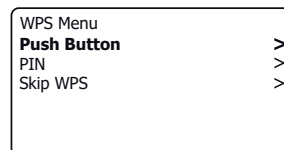

'PIN' - the display shows an identification number which you must enter into your router using a web browser (refer to your router's user documentation). You should then press the **Tuning/Select** control on the radio. The two devices should then connect with the encryption key sent automatically to the radio.

'Skip WPS' - if you wish to enter the encryption key yourself (or if it was previously entered).

If you chose Push Button or PIN the screen will then show *'Connecting...'* and then *'Setup wizard completed'*. Press the **Tuning** control to exit the setup wizard and then go to paragraph 10 on the next page.

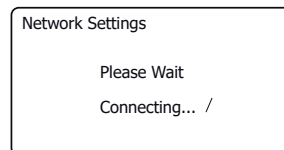

7. If your network is configured without an encryption key, the screen should say *'Connecting...'*, and then *'Setup wizard completed'*. Press **Tuning** to exit the setup wizard and show the Main menu. If this is the case then you have successfully connected your radio to your network, so please go to paragraph 10 on the next page.

8. If the screen displays *'Key:'*, it is because the network is using WEP or WPA encryption. You will need to enter the correct text key into the radio to allow it to communicate with your WiFi network. If you do not have the key, then you should obtain it from the person who set up your network. Broadband routers often have an encryption key already set up by the supplier, in which case you should refer to the documentation provided with it. WPA is used here to also include WPA2.

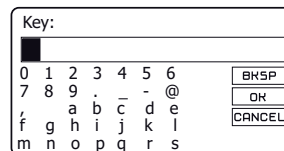

Connecting to your computer network - cont.

WEP keys are 10 or 26 characters long (using 0 - 9, and A - F). WPA keys may be between 8 and 63 characters.

Note: WEP is now not considered to be secure, but it is supported by the radio for compatibility with older WiFi installations.

- To enter the key, characters are selected and entered using the **Tuning** control. As you rotate the control, the highlight scrolls through the available characters as well as the three controls on the right. The character currently highlighted will be entered when you press the **Tuning** control. [See also 'Text Entry' page 8.](#)

Do this as needed until the complete key has been entered. Remember, WEP keys only use the numbers 0-9 and letters A-F. WPA keys are sensitive to upper and lower case characters. You must enter the key **exactly** or the radio will not connect to the network.

The three controls on the right-hand side of the screen have special functions. You can quickly access these by pressing the **Info** button and then using the **Tuning** control as needed:

- select '**BACKSP**' to erase a character just entered (long press to clear); **Info** again to continue
- select '**OK**' when the complete key has been entered
- select '**CANCEL**' to cancel and re-run the Network Wizard

If a key has previously been entered for the selected SSID then the display will show 'Key: [Set]'. If you have previously entered a different key, you must clear this by selecting the '**BACKSP**' symbol. This will remove the '[Set]' indication.

After the final character of the key has been entered, highlight the '**OK**' symbol and press the **Tuning** control. The screen will show 'Connecting...' and then 'Setup wizard completed'. Press the **Tuning** control to the exit setup wizard. The radio should now be able to connect to the network.

- Once you have connected your radio to the network (and therefore also to the Internet) it will display the Main menu. Press the **On/Off** control to put the radio into Standby mode. It should then display the time as obtained from the Internet. If the time display is not correct for any reason, it can easily be adjusted later. [see page 37. 'Manually setting the clock.'](#)

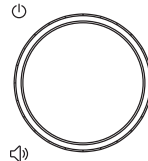
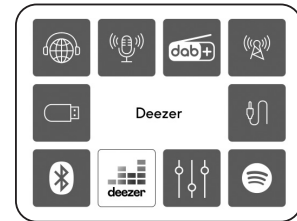
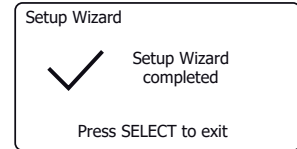
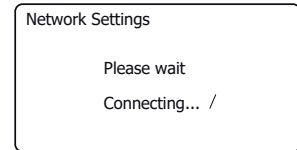
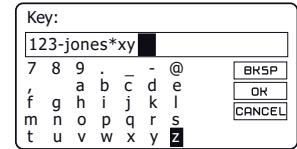
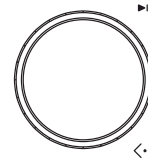

Connecting to your computer network - cont.

If you have followed the steps on the preceding pages successfully, your radio will have connected to your router, and then made a connection to the Internet and set its clock.

You can now listen to radio stations via the internet and use the other features of your radio ([see page 17 onwards](#)).

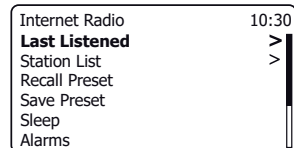

Changing the network connection

In the sections above, you chose how your radio would be connected to your network, using a WiFi connection. If you change your broadband supplier or change location, you may find that you need to connect to a different WiFi network. The Network Settings menu allows you to change your radio's network settings, scan for an alternative WiFi network, or manually configure the network parameters.

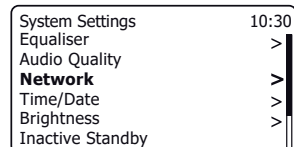

The steps outlined below describe how you can do this - see also the section '[Network profiles](#)' on [page 49](#). If you have no need to do this, however, [please skip to page 17](#).

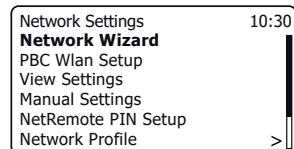

Configuring the radio to use an alternative WiFi connection

1. From the Network Settings menu select '*Network wizard*'. This will present you with details of any WiFi networks that are found. Scroll down the list using the **Tuning/Select** control to the desired network name. Press the control to select this network.

The radio will then use its WiFi system to communicate with the network. Depending on the settings for the new network you may need to [enter an encryption key](#) (see [pages 13-14](#)). By default the radio will then acquire an IP address and other network settings from the network's router automatically using a system known as DHCP.

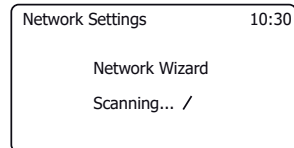

2. Instead of the '*Network Wizard*' option, the '*PBC Wlan Setup*' option can be used if you know that the new network supports WiFi Protected Setup (WPS). You will then be asked to press the WPS button on your router. Then press the **Tuning** control to initiate the connection process.



Note: Most users will not need to use manual network configuration.

If you do not wish to use DHCP for automatic network configuration, then you will need to enter some network settings manually. This facility is provided to allow the product to be used with networks where the configuration of devices is not managed by the router, or if your network is configured with a hidden SSID, or where customised settings may be required. In such cases it is assumed that the user already has sufficient knowledge to understand the terms and settings used for this purpose. IPv4 address schemes are used.

- From the radio's Network Settings menu, select '*Manual Settings*'. You must then choose to connect using the '*Wireless*' connection. There are as many as nine '*Wireless*' settings screens, shown by the '*1 of 9*' progress marker in the top right corner of the display.
- The subsequent menus allow configuration of the following parameters:
 - DHCP - On or Off
 - IP address - e.g. 192.168.1.25
 - Subnet mask - e.g. 255.255.255.0
 - Gateway address - e.g. 192.168.1.1
 - DNS address (primary and secondary addresses)
 - SSID - needed for WiFi connections if the SSID is not broadcast
 - WEP / WPA / WPA2 key and settings

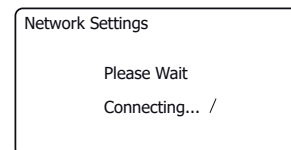
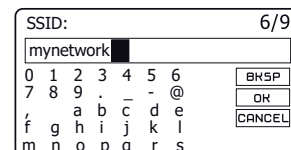
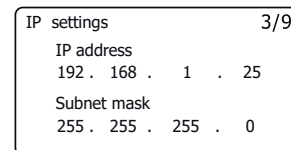
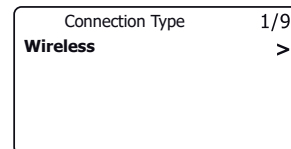
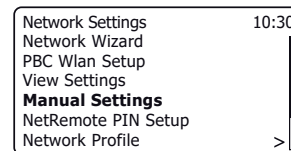

When entering the SSID or the WiFi pass key, the three controls on the right-hand side of the screen have special functions. You can quickly access these by pressing the **Info** button and then use the **Tuning** control as needed:

- select '**BKSP**' to erase a character just entered (long press to clear); **Info** again to continue
- select '**OK**' when the complete encryption key has been entered
- select '**CANCEL**' to cancel and go back to the TKIP / AES options screen

- Upon completion of the settings the radio should connect to the network. If the connection is made successfully, the radio will return to the Network Settings menu. If the unit cannot connect, then it will display a '*Failed to connect*' message. You will then need to identify which setting may need to be changed, or whether some other network issue is responsible. Once connected to the network, the settings are saved. They are retained in memory while the radio is disconnected from the mains.



Internet Radio

Internet Radio - the basics

Before you can use your radio to listen to broadcasts via the Internet, it is necessary to have connected it to your WiFi network. [Please see page 11 for details.](#)

There are many thousands of radio broadcasts available via the Internet as well as 'Podcasts'. Your radio provides several ways of searching for broadcasts in order to make finding and choosing them easier. The Rambler Max connects to a database of radio stations which serves many users in many countries. This means that there is a very wide range of programme content available.

Once you have found the radio stations that you like, you may store them as presets within the radio. The radio allows you to store up to 20 presets.

You may search for an Internet radio station by Location. If you know the name of the station and the country from which a station is broadcast this may be the easiest method to find a station. It is also a great way to experience radio from other parts of the world.

Having chosen a region, you may also search for an Internet radio station by Genre. If you prefer a particular type of music, Classical, for example, you may search for a radio station that broadcasts that type of music, and you can then choose from a list of Classical Music radio stations.

If you know part of the name of an Internet radio station, you can enter it into the radio and it will search for stations that match that name. This can be helpful if you are unsure of the location or genre of a particular station.



Internet radio



Selecting a radio station by location and genre

The Internet Radio menus may offer one or more localised options for your country and region, based on your router's public address on the internet, which it receives from your broadband provider. These may include radio stations from national broadcasters, those located near major cities, and so on.

1. Press **On/Off** to switch on the radio. Press **Mode** until Internet Radio is selected.
2. Press **Menu** and choose 'Station List' and then 'UK' (or the region offered). You may then choose from 'Local', 'Popular', 'BBC' (or your equivalent), 'Genres' and 'Cities'. Choose the desired category, and then choose the particular station that you wish to listen to.
3. With your chosen radio station name highlighted, press **Tuning**. The radio will then connect to the chosen station and start playing.
4. To choose radio stations from a different location choose 'Station List', then 'Location', then scroll the list of continents and then countries in either direction, selecting each option by pressing **Tuning**.
5. For the chosen location, a list of genres may then be offered to help narrow your search. After choosing a genre (if applicable) highlight your chosen radio station. Press **Tuning** to connect to the station and start playing.

If the radio is unable to connect to a particular radio station this may be for one of the reasons explained in ['Troubleshooting' on page 51](#).

Searching for a radio station by name

1. Press **Menu**.
2. Choose 'Station List' then 'Search'.
3. To enter the search word(s) rotate **Tuning** to highlight each character for the search in turn, and press **Tuning** to enter. If you make an error rotate the control or use **Info** to access the delete character 'BKSP' on the screen and then press **Tuning**. Rotate the control or press **Info** again to go back to the character selection. After the final character of the search has been entered, use **Info** and then **Tuning** to highlight the 'OK' symbol on the screen and then press the control to finish. [Also see 'Text Entry' page 8](#).

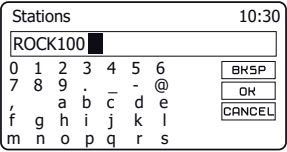
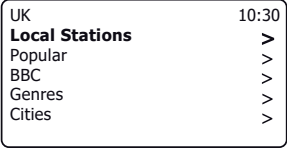
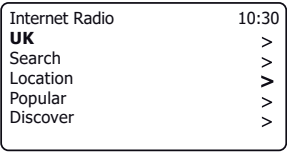
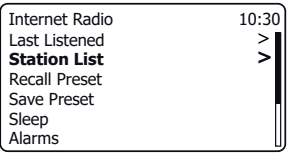
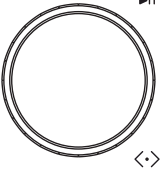

Selecting a Popular station / Discover new stations

The Popular stations is option is provided to highlight stations which are particularly popular with listeners around the world.

The Discover option allows you to specify the location, genre and language of a radio station and then provides a selection based on the choices you have made.

1. When in Internet Radio mode press **Menu**.
2. Choose 'Station List' and then 'Popular' or 'Discover'.
3. Highlight your chosen radio station or search option. Press **Tuning** after each selection until you have chosen a radio station.

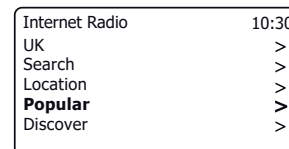
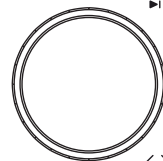
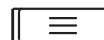

Selecting a podcast

Radio broadcasters and individuals may make programmes which are not part of a radio stations regular content. These are commonly known as Podcasts.

1. Press **Mode** until Podcasts is selected.
2. You may then use **Tuning** to search by location, genre, or using part of the name of the Podcast. The searches operate in exactly the same way as when searching for a conventional radio station.
3. Unlike conventional radio, you may pause and resume playing of a Podcast. Simply press **Tuning** within a programme to pause or resume.

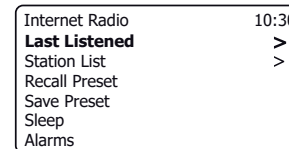
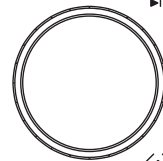
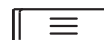
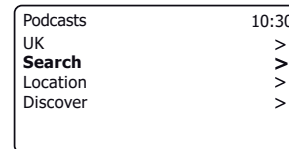
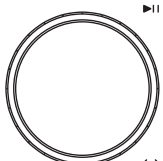

Last Listened

The Last Listened feature provides you with quick access to the ten most recently listened to radio stations and podcasts. As each new radio station is listened to the oldest item is deleted from the list. The Last Listened list is stored when the radio is disconnected from the mains.

1. When in Internet Radio or Podcast mode, press **Menu** and then choose 'Last Listened'.
2. The display will then show a list of the last ten Internet radio stations or Podcasts.
3. Highlight whichever you wish to listen to and then press **Tuning** to cause your radio to reconnect to that radio station or podcast.



Presetting stations Internet radio, DAB and FM

Your radio has 20 memory presets for Internet radio / Podcast, 20 DAB and 20 FM which can easily be set to store the details of any radio station. The radio station presets are retained even when the radio is switched off.

For internet radio only, please also see the sections '[Last Listened](#)' on page 19.

Storing a preset

1. Switch on your radio and tune to the required Internet Radio / Podcast, DAB or FM station.
2. To store to any of presets 1 to 5 *press and hold* one of the numbered **Preset** buttons.
3. For presets 6-20, or to see the full list, *press and hold* the **Presets** button to display the 'Save Preset' menu.
4. Use the **Tuning** control to scroll through the preset list until you reach an unused preset or a preset that you wish to change. Press and release the **Tuning** control to store the preset. 'Preset stored' will be shown on the display. Repeat this procedure as needed for the remaining presets.
5. Stations which are already stored in the presets may be over-written by following the steps above.

Recalling a preset

1. Select the required mode (Internet Radio / Podcast, DAB or FM) using the **Mode** button.
2. To recall any of presets 1 to 5 *press and release* one of the numbered **Preset** buttons.
3. For presets 6 to 20, or to see the full list, *press and release* the **Preset** button to display the 'Recall Preset' menu.
4. Use the **Tuning** control to select the desired preset station or podcast. Press and release the **Tuning** control. Your radio will then connect to the station or podcast stored in the preset memory.

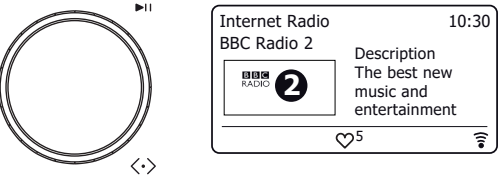
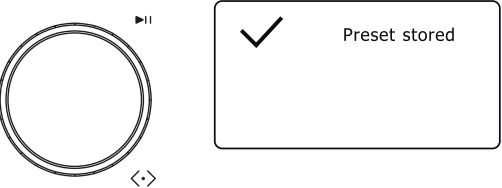

Display options - Radio / Bluetooth / USB

Your radio has a range of display options when in Internet Radio, Podcast, DAB, FM, Bluetooth and USB modes. Press the **Info** button to cycle through the various options.

When images are displayed (station logos, album art, DAB Slideshow) they may be displayed full screen by pressing and holding the **Menu** button. Press and hold the button again to exit.

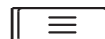

Internet Radio / Podcast display options

Description, genre, reliability, format, playback buffer, date.

Additional or alternative information may be displayed when listening to Podcasts.

DAB Radio display options

Station name, scrolling text, program type, multiplex name, channel & frequency, signal strength / error rate, bit rate, audio type and date.

Some stations may also broadcast station logos or pictures (known as DAB slideshow). Press and hold the **Menu** button to change the image size.

For the signal strength/error rate a low error number indicates a better quality of DAB radio signal. The minimum signal marker 'I' which separates the left and right parts of the signal graph shows the minimum signal level required for satisfactory reception.

FM Radio display options

Station name, scrolling text, frequency, program type and date.

In FM mode your radio can use the Radio Data System (RDS) to display the radio station name and additional text when provided by the broadcaster and where the radio signal is sufficiently clear.

Bluetooth display options

If your connected device is able to provide information from the track being played, your radio can display the following in Bluetooth mode:- Title, album and artist details.

USB display options

Progress bar, artist, album, folder, format and date details.



Using USB memory devices

This section describes how to use your radio to access and playback your audio files via USB memory devices. USB memory devices plug into the rectangular slot on connector panel under the radio.

Important: Your radio is only designed to work with USB flash memory devices. It is not intended to be connected to hard disk drives or any other type of USB device.

The Rambler Max radio has been tested with a range of USB memory devices of up to 256GB capacity. USB memory must use the FAT or FAT 32 filing system in order to operate with your radio. Your radio is unable to play from media formatted using the exFAT, NTFS or other formats.

It is possible to use SD and micro-SD cards for media storage and playback when held in a suitable USB adaptor. However, due to the wide variation of such adaptors, it is not possible to guarantee that all adaptor / card combinations will work with the radio.

The audio coding supported is MP3. Other audio codings are not supported.

Recommendations:

Unless you have only a few files on the USB memory device, do not place all files in the root folder.

The number of items (files / sub-folders) in any folder should be less than 2000.

Searching and playback will be more responsive if the number of files in any one folder is limited (we suggest not more than 250).

It is recommended that the USB memory is reformatted in your computer before adding your music files.

The maximum depth of folder nesting permitted is 8 folder levels (but playback is only from the currently selected level).

Shuffle and Playlist functions are limited to 500 tracks.

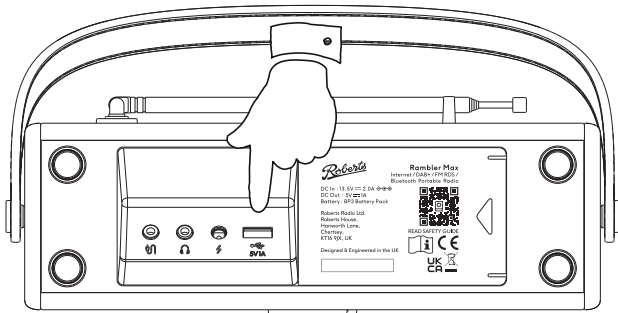

Cautions:

Use only USB devices which are small enough to sit under the radio without straining the device or the socket. To use larger USB devices, we recommend using a short USB extender cable with a USB type A plug and USB type A socket.

Remove the USB memory before carrying the unit or if not using the USB feature for a prolonged period.

Place the unit in Standby mode before removing your USB memory device.

The USB connection is intended only for flash memory devices. Other types of storage media are not supported.

Playback via USB of files stored on phones, tablets, MP3 players, etc. is not guaranteed.



Playing files from USB memory devices

1. Carefully insert the USB memory device into the USB socket on the underside of the radio. Press **On/Off** to switch the unit on.

The radio may detect that the memory has been connected, in which case it will ask whether you wish to open the folder view of the memory contents. Press **Tuning** to select 'Yes' and skip to step 4 below.

If the USB memory was not automatically detected, proceed as follows.

2. To select USB playback mode, press **Mode** as needed until the 'USB mode' is selected. If needed press **Menu**.
3. Rotate **Tuning** until 'USB Playback' is highlighted on the display and press the control. The radio will now list the content stored on the USB memory device. If there are many files or folders this may take a few seconds.
4. Rotate **Tuning** to highlight the required folder and press the control to enter the current folder. The list of tracks in the current folder will be displayed.

Alternatively, if you have nested folders (such as album folders within an artist folder) then you will simply step to the next folder level.

5. Rotate **Tuning** to select a track and press the control to begin playing from the highlighted track.

Files are sorted by filename in numeric-alpha order (0 - 9 ... A - Z) before being played. Albums will play in the correct order if the filename begins with the track number (use leading zeroes if more than 9 tracks).

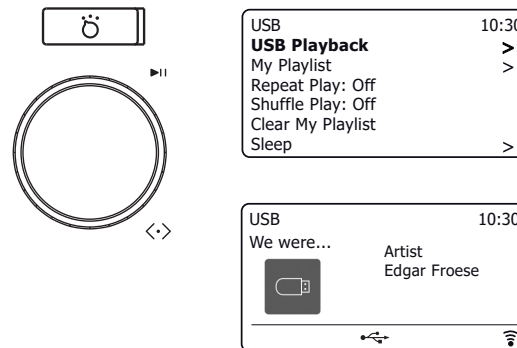

Controlling playing of files

1. Press **Tuning** to pause playing of the current track.
2. Press **Tuning** again to resume playing from the point where it was paused.
3. Rotate **Tuning** clockwise to play the next track in the list.
4. Rotate **Tuning** anti-clockwise to play the previous track in the list.

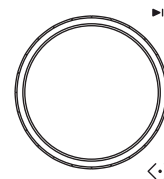

Playlists

You may wish to set up a list of music tracks or folders of files from a USB memory device which can then be played as background music for a party, for example. Your radio can be configured to hold a queue of up to 500 tracks in a playlist menu. The playlist is held in the radio until the external power is removed, or until the playlist is cleared from the menu.

Adding a track or folder to your playlist

1. When selecting (or when playing) a track using a USB memory device **apply a long press** on the **Tuning** control and the display will show 'Added to My playlist'.
2. The track will be added to the playlist for playback later.
3. To add multiple files at once, highlight a desired folder and **apply a long press** on **Tuning**. The display will show 'Added to My playlist'.
4. Each of the tracks within the selected folder will be added to the playlist individually. This allows any unwanted tracks to be removed from the playlist if needed (see below).

Viewing your playlist

1. Ensure you are in the main USB menu. Press **Menu** if needed.
2. Choose 'My Playlist' to enter the playlist.
3. Rotate **Tuning** to scroll through the playlist. USB tracks will show their file name.

Erasing a track from the playlist

1. Ensure you are in the main USB menu. Press **Menu** if needed.
2. Choose 'My Playlist' to enter the playlist.
3. Rotate **Tuning** until the track you wish to erase is highlighted. **Apply a long press** on **Tuning**.
4. To delete the track rotate **Tuning** until 'YES' is highlighted, then press the control to confirm the deletion. If you do not wish to delete the track from the list rotate **Tuning** to highlight 'NO' and press the control to cancel the operation.

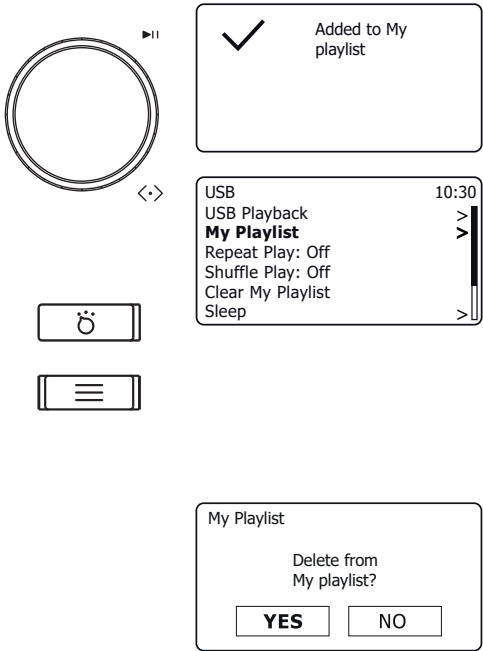

Clearing the playlist

1. Press **Menu**. To clear the whole playlist choose '*Clear My Playlist*' and then choose '**YES**'. If you do not wish to clear the playlist choose '**NO**'.

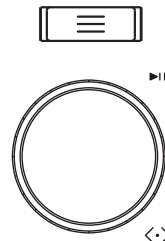

Playing your playlists

1. Ensure you are in the main USB menu. Press **Menu** if needed.
2. Choose '*My Playlist*'.
3. To play the playlist from a particular track, rotate **Tuning** until the desired track is highlighted then press the control to start play.
4. While playing from the playlist, you can use this function to jump to a particular track within the playlist. While playing from the playlist, you may add additional tracks or folders or remove specific tracks (please see the preceding page).

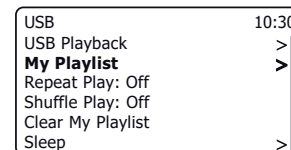
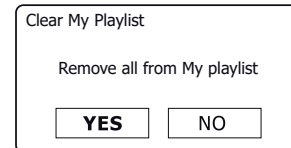
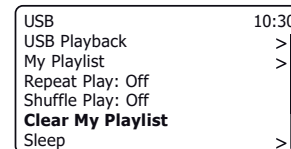

Repeat and Shuffle play options

When playing tracks from your USB memory device you may choose to repeat the current folder or playlist, or to play the files in random order, or both options together.

Repeat tracks

1. Ensure you are in the main USB menu. Press **Menu** if needed.
2. Rotate **Tuning** until 'Repeat Play' is highlighted.
3. To activate the repeat option press **Tuning** so that 'On' appears on the display. Your selected tracks will now be played repeatedly and the **Repeat** icon will show on the display.
4. To turn off the repeat option highlight 'Repeat Play' and press **Tuning** so that 'Off' appears on the display.
5. Press **Menu** to exit.

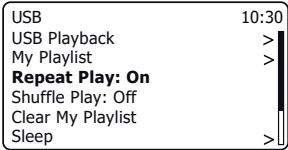
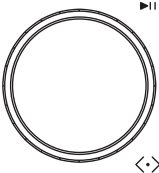

Play tracks in random order

1. Ensure you are in the main USB menu. Press **Menu** if needed.
2. Rotate **Tuning** until 'Shuffle play' is highlighted.
3. To activate the shuffle option press **Tuning** so that 'On' appears on the display. Your selected tracks will be played in random order and the **Shuffle** icon will show on the display.
4. To turn off the shuffle option highlight 'Shuffle play' and press **Tuning** so that 'Off' appears on the display.
5. Press **Menu** to exit.

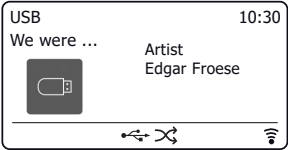
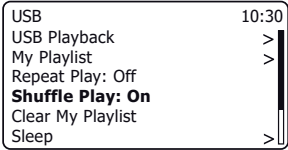
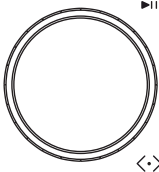

If both Repeat and Shuffle playback options are set to 'On' then both Repeat and Shuffle icons will be shown in the display.



DAB Radio

1. Carefully extend the telescopic aerial. Press **On/Off** to switch on the radio. If the radio has been used before the last used mode will be selected.
2. Press **Mode** as needed to select the DAB Radio mode.
3. If this is the first time that the DAB mode is used a scan of the Band III DAB channels will be carried out. The display will show 'Scanning'. During the scanning process, as new stations are detected the station counter will increase and the stations will be added to the list which is stored in the radio. The bar graph indicates the progress of the scan. When scanning is completed the radio will list the stations found (in numeric-alpha order 0....9...A...Z), unless it has previously tuned to a DAB station.
4. Rotate **Tuning** to scroll through the list of available DAB radio stations.
Press **Tuning** to select the highlighted station. The display may show 'Connecting...' while the radio re-tunes. Use the **Volume** control to set the sound level as needed.
5. If the station list is still empty after the scan the display will show 'Service not available'. If no stations are found it may be necessary to relocate your radio to a position giving better reception.

Selecting a DAB radio station

1. When playing a DAB radio station, rotate **Tuning** to access the radio station list and to scroll through the available stations.
2. Press **Tuning**. The display may show 'Connecting...' while the radio re-tunes.
Note: A question-mark in front of the station name indicates that the station has not recently been detected by the radio.

[The use of the radio station presets is described on page 20.](#)

Secondary services

Some radio stations may have one or more additional broadcasts associated with them. If these are available, they will appear immediately after the main station as you rotate the **Tuning** control clockwise. To tune to the selected service, press **Tuning**.

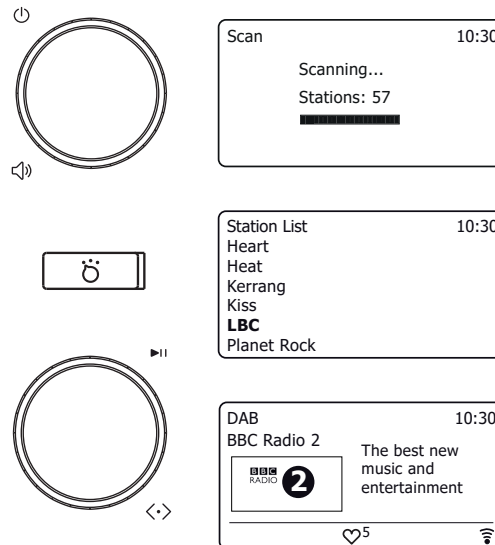

Finding new DAB radio stations

Should you wish to use your radio for DAB reception in a new location, or if no stations were detected during the initial scan, you can follow this procedure to allow your radio to find out which DAB radio stations are available.

1. Press **Mode** as needed to select the DAB Radio mode.
2. Press **Menu**.
3. Choose 'Scan'.
4. Press **Tuning**. The display will show 'Scanning' and your radio will perform a scan of the Band III DAB frequencies. As new stations are found the station counter will increase and stations will be added to the list. The bar graph indicates the progress of the scan.

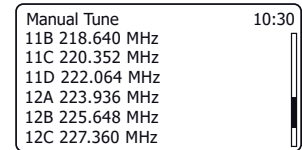
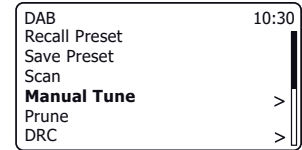
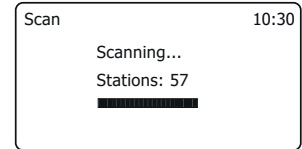
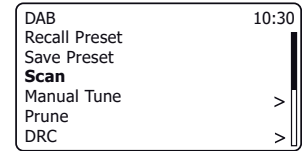
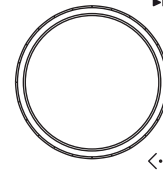

Manual Tuning

Manual tuning allows you to tune your radio to a particular DAB frequency in Band III. Any new stations found will be added to the station list. This function can also be used to assist the positioning of the telescopic aerial or the radio to optimise reception for a specific channel or frequency.

1. When in DAB mode, press **Menu**.
2. Choose 'Manual Tune'.
3. Choose the required DAB channel. Press **Tuning**.

When the radio has tuned, the display shows the channel number and frequency, and the name of the DAB multiplex found (if any). A bar graph shows the signal strength and is useful if you need to reposition the radio or its aerial. The minimum signal marker 'I' which separates the left and right parts of the signal graph shows the minimum signal level required for satisfactory reception. Any new radio stations found on the tuned DAB multiplex will be added to the list stored in the radio.

4. Press **Menu** to choose a different frequency.
5. Press **Menu** a second time to access the main DAB menu.

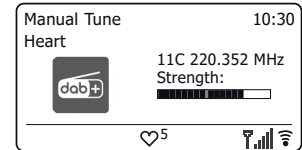
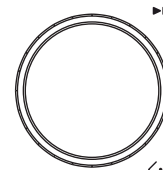
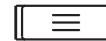

Dynamic Range Control settings

The DRC facility can make quieter sounds easier to hear when your radio is used in a noisy environment.

1. When in DAB mode, press **Menu**.
2. Choose 'DRC' and then choose the required DRC setting (default is Off).
DRC Off - DRC is switched off, Broadcast DRC will be ignored. DRC Low - DRC level is set to 1/2 that sent by broadcaster. DRC High - DRC is set as sent by broadcaster.
3. Press **Tuning** to confirm the setting. **Note:** Not all DAB broadcasts use the DRC function. If the broadcast does not provide DRC information, then the DRC setting in the radio will have no effect.

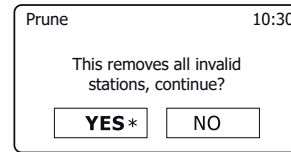
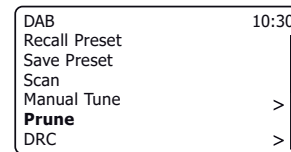
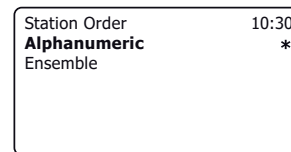
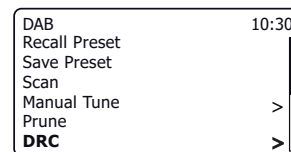
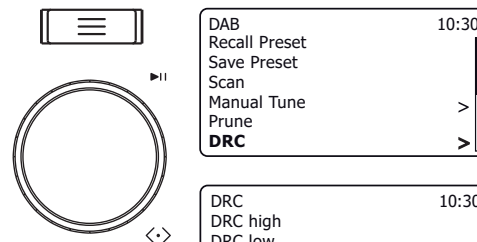

Station order setup

Your radio has 2 station order settings from which you can choose. The station order settings are, alphanumeric and ensemble. **Note:** The default station order on your radio is alphanumeric.

1. When in DAB mode, press **Menu**.
2. Choose 'Station Order' and then choose 'Alphanumeric' (list alphabetically) or 'Ensemble' (organised by DAB multiplex).

Prune stations

If you move to a different part of the country, some of the stations listed may no longer be available. Also, some DAB services may stop broadcasting or change location or frequency. Stations which cannot be found, or which have not been received for a very long time are shown in the station list with a question mark. The Prune stations function will delete the marked DAB stations from your station list.

1. When in DAB mode, press **Menu**.
2. Choose 'Prune' and then choose 'YES' to cause the invalid station names to be removed from the station list. If you do not wish to prune stations choose 'NO'.

Note: If you have moved your radio to a different part of the country you should also carry out a search for new stations ([please see the section 'Finding new stations' on page 28](#)).



Operating your radio in FM mode

1. Carefully extend the telescopic aerial and press **On/Off** to switch on the radio.
2. Press **Mode** as needed to select the FM Radio mode.
3. Rotate **Tuning** in a clockwise direction. The displayed frequency will increase. Press **Tuning** to carry out an auto-tune. Your radio will scan up the FM band from the currently displayed frequency and will stop scanning when it finds a station of sufficient strength.
4. The display will show the frequency of the signal which has been found. If RDS information is available, after a few seconds the display will show the radio station name.
If you only hear hiss or interference, simply press **Tuning** to scan further. Your radio may have found a spurious interference signal.
5. To find more FM stations press **Tuning** to repeat the scan operation. To scan down in frequency, rotate **Tuning** in an anti-clockwise direction first and then press the control. Your radio will scan down the FM band from the currently displayed frequency and will stop scanning when it finds a signal of sufficient strength.
6. When the end of the waveband is reached your radio will recommence tuning from the opposite end of the waveband.
7. Use the **Volume** control to adjust the sound level as needed.

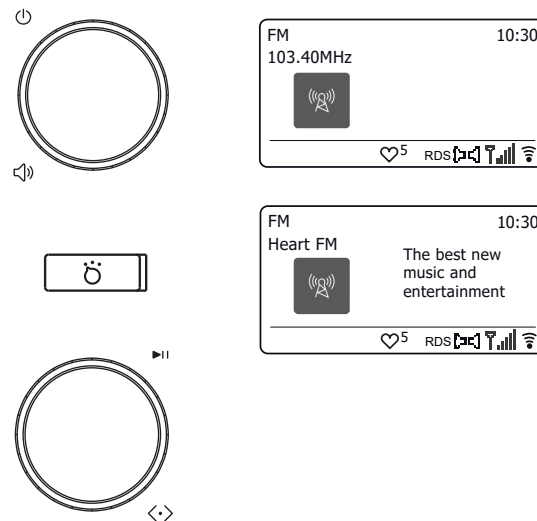

Manual tuning

1. Rotate **Tuning** to tune to a station. The frequency will change in steps of 50kHz.
2. Adjust the volume.



Scan sensitivity setting - FM

Your radio will normally scan for FM broadcasts which are strong enough to give good reception. However, you may wish the Auto-scan function to also be able to find weaker signals, possibly from more distant radio transmitters. Your radio includes a local / distant option for the Auto-scan function.

1. When in FM mode, press **Menu**.
2. Choose 'Scan Setting'.
3. To set your radio so that only the stations with the strongest signals are found during scanning choose 'YES'. (Normally this will restrict scanning to local transmissions).
4. Alternatively, to set your radio so that all available stations are found during scanning (local and distant transmissions) choose 'NO'.

Note: The initial setting (out of the box, or after a System Reset) causes the radio to ignore weaker (or more distant) signals.

Stereo / Mono switching - FM (headphone output only)

Your radio will play stereo FM broadcasts in stereo (via the headphone output only) provided that the received signal is of adequate strength. However, as a stereo signal becomes weaker the audio signal will become poorer.

It may be preferable to force the radio to play the station in mono in order to reduce the level of background hiss.

1. Ensure your radio is in FM mode and tune to the required FM station.
2. To change the audio setting, press **Menu**.
3. Choose 'Audio Setting'. The current audio setting is indicated with an asterisk. To switch to mono in order to reduce the hiss from a weak FM signal choose 'YES' or choose 'NO' to return to the normal automatic 'stereo or mono' setting.

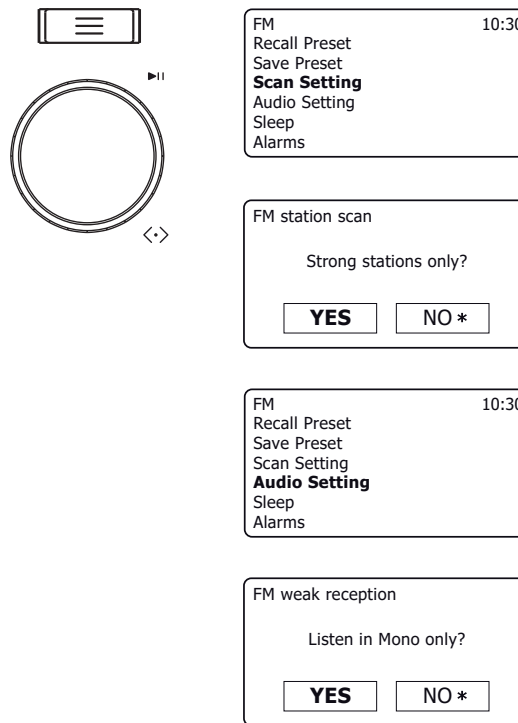

The Bluetooth mode allows you to stream music and play audio from video files to your radio from Bluetooth capable devices such as your mobile phone, computer, tablet etc.

- When your Rambler Max is in a 'discoverable' state other Bluetooth devices can detect, pair with or connect to it.
- 'Bluetooth pairing' occurs when two Bluetooth enabled devices agree to establish a connection and communicate with each other.

Connecting Bluetooth devices

1. Ensure that the Bluetooth capability on your phone, tablet or PC is enabled. You may need to refer to the user documentation for your device, since the method will vary with each device.
2. Ensure your radio is switched on.
3. Press the **Mode** button on your radio until the Bluetooth mode is selected. Your radio will show that it is 'discoverable' by displaying the message "*Looking for device...*".

If the radio is already connected to another device then its device name will be displayed. To cause the radio to become 'discoverable', press **Menu** and select "*Disconnect*". Your radio will then become discoverable by other devices.

4. Using the Bluetooth settings of your phone, tablet or PC direct it to search for discoverable devices. After a few seconds, you should see a device named '*Rambler Max*'. Just occasionally it may take longer for the radio to be found by your device.
5. Select '*Rambler Max*' to cause your phone, tablet or PC to pair with your radio and to establish a connection. Some devices will also require you to confirm the connection on the device.
6. Once the connection is established the device name will be shown and you can now begin playing music from your smart-phone, tablet, etc.

Some Bluetooth devices may require a 'Passkey' (an authentication key) in order to establish a link between devices. A passkey is similar to a password, although you only need to use the passkey once to establish a link. If your device asks for a passkey to be able to pair with your radio then enter a code of 0000 (four zeroes).

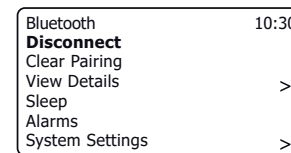
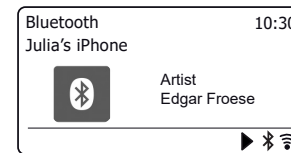
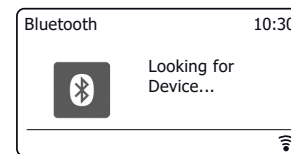
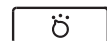

Playing audio files in Bluetooth mode

When you have successfully connected your radio with your chosen Bluetooth device you can start to play your music using the controls on the device.

1. Once playing has started adjust the volume to the required setting using the **Volume** control on your radio or on the connected Bluetooth device.
2. The audio player in your phone, tablet or PC may be able to respond to the **Play**, **Pause**, **Next** track, **Previous** track functions on the radio.

Press **Tuning** to pause playback of the current track.

Press **Tuning** again to resume playback from the point where it was paused.

Rotate **Tuning** anti-clockwise to playback the previous track.

Rotate **Tuning** clockwise to playback the next track.

Note: Not all player apps or devices may respond to all of these functions.

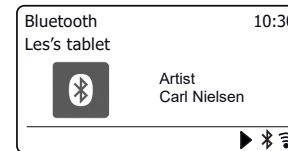
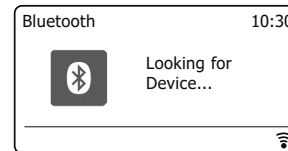
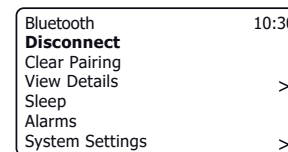
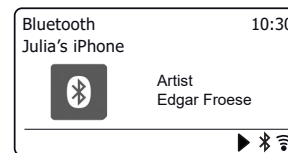
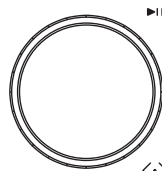
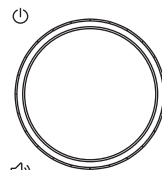

Connecting a different Bluetooth device

You can only have one Bluetooth device connected to the radio at any one time although it may be paired with several devices. Once you have a Bluetooth enabled device connected to your radio it cannot be interrupted by another Bluetooth device unless you choose to break the connection.

1. To connect to a different device, press **Menu** and select "Disconnect". The radio will then show 'Looking for Device...'.
2. You can now pair the radio with a new device using its Bluetooth settings. The radio will be listed on the device as 'Rambler Max'. When the new Bluetooth connection has been established radio will show the name of the connected device and the **Bluetooth indicator** will appear at the bottom of the display. You may then play music from the new device through the radio.
3. If you no longer want your Bluetooth device to be paired with your radio you will need to delete the 'Rambler Max' pairing on the device. Please refer to your device's Bluetooth documentation.



Disconnecting a Bluetooth device

You may disconnect your Bluetooth device using the Bluetooth menu.

1. To disconnect your Bluetooth device, press **Menu**, then choose '*Disconnect*' and then choose 'YES'. Your radio will become 'discoverable' by other devices.

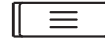

Bluetooth	10:30
Disconnect	
Clear Pairing	
View Details	>
Sleep	
Alarms	
System Settings	>

Clear Bluetooth Pairings

You may clear all stored Bluetooth pairings from your radio using the Bluetooth menu.

1. To clear all stored Bluetooth pairings, press **Menu**, then choose '*Clear Pairing*' and then choose 'YES'. Your radio will now have no pairings stored, and will also become 'discoverable' by other devices to allow new pairings to be made.

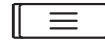

Bluetooth	10:30
Disconnect	
Clear Pairing	
View Details	>
Sleep	
Alarms	
System Settings	>

Additional Bluetooth connection options

1. To view the details of the currently connected Bluetooth device, press **Menu**, then choose '*View Details*' and then choose the desired option.
2. '*Bluetooth Info*' shows the connection status of your radio and its Friendly Name as used for Bluetooth pairings.
3. '*Connected Device*' shows details of the currently connected Bluetooth Device and its support for remote control of audio playback.
4. '*Paired Device List*' shows all of the currently stored pairings. You can use this list to directly reconnect to a different device, provided that device is within range and has its Bluetooth functionality enabled.



Bluetooth	10:30
Disconnect	
Clear Pairing	
View Details	>
Sleep	
Alarms	
System Settings	>

View Details	10:30
Bluetooth Info	>
Connected Device	>
Paired Device List	>



Bluetooth - general information

Bluetooth connectivity performance may vary depending on the connected Bluetooth devices. Please refer to the Bluetooth capabilities of your device before connecting to your radio. All features may not be supported on some paired Bluetooth devices.

A Bluetooth connection can provide a link for audio up to a distance of approximately ten metres. When pairing two Bluetooth enabled devices, for convenience, we recommend they should be no more than 2 to 3 metres apart. The presence of other functioning Bluetooth devices during connection may lead to operational difficulties.

Bluetooth is a short-range radio communication system and generally Bluetooth devices can communicate with each other clearly within a regular sized room or office. The reliability of a Bluetooth connection between different rooms will greatly depend upon the construction of the building.

Bluetooth communication range may be substantially reduced if the signal passes through a solid object. Human bodies, brick and concrete walls, heavy furniture or bookcases will all reduce the operational range of your Bluetooth devices to a greater or lesser extent. Glass, dry-wall or wood paneled walls and office partitions may have a less severe but noticeable effect. Metal pipes, foil-lined plasterboard, metal window frames and domestic wiring can also have an effect. You should position your Bluetooth devices closer to each other if you observe communication difficulties.

WiFi networks and cordless phones generally use similar radio frequencies to Bluetooth and may interfere with one another. If any interference is noticed, then try relocating the radio or one of the other devices.

The Bluetooth capabilities of your radio enable it to receive audio from many Bluetooth capable devices including mobile phones, personal computers and tablets. Only one Bluetooth device can be connected to your radio at a time. It supports the following Bluetooth profiles and functionality.

- Your radio supports A2DP (Advanced Audio Distribution Profile) which is a stereo audio connection that streams stereo music from PCs, mobile phones etc. SBC audio codec is supported.
- Your radio supports AVRCP (Audio Video Remote Control Profile) which allows your radio to control music playback from the connected device.

Note: Some mobile phones may temporarily disconnect from your radio when you make or receive calls. Some devices may temporarily mute their Bluetooth audio streaming when they receive text messages, emails or for other reasons unrelated to audio streaming. Such behaviour is a function of the connected device and does not indicate a fault with your radio.

Note: If the unit is in the Bluetooth mode and it is not playing from a Bluetooth device for more than 15 minutes it will automatically switch to the standby mode. If powered from batteries the radio will then switch off completely. To use the radio again, simply press the On/Off control to switch it on.



Clock and Alarms

Automatically updating the clock

Your radio can update the clock automatically from the internet, or from DAB or FM radio. Which you choose may depend on which operating modes you generally use, or on the availability of the required radio signals. Updating the time from the internet will generally be the preferred option.

Alternatively you may specify that the time is not automatically updated. In this case the clock may need to be set manually after a power interruption.

1. With your radio switched on, press **Menu**.
2. Choose 'System Settings', 'Time/Date', 'Auto Update' and then choose an update option from 'Update from DAB', 'Update from FM', 'Update from Network' or 'No update' as required. Select 'Update from Network' to get time updates from the internet.
3. Updates are performed when the radio is in standby, or when the radio is being used in the specified update mode. For internet time updates, the WiFi connection must be available. For DAB or FM radio time updates, the aerial should be extended and the radio must have been previously tuned to a DAB or FM radio station, as appropriate.

Setting the clock format

The clock display used in Standby mode and on the playing mode screens can be set to 12 or 24 hour format. The selected format is then also used when setting the alarms.

1. With your radio switched on, press **Menu**.
2. Choose 'System Settings', 'Time/Date', 'Set Format' and then select either 12 or 24 hour. The current clock display format is marked with an asterisk.

If the 12 hour clock format is chosen, the radio will then use the 12 hour clock for the setting of alarms, and will display a 12 hour clock with an AM or PM indicator when in standby mode.

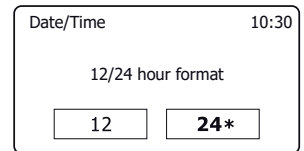
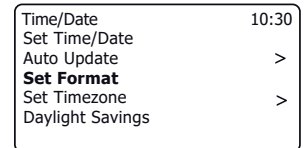
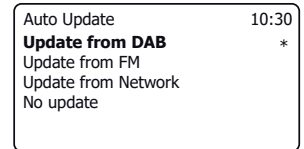
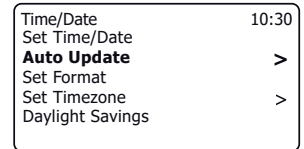
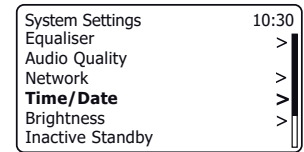
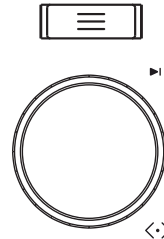

Manually setting the clock

After a connection to the Internet has been established, your radio will normally set its clock automatically to the local time zone that was specified during setup ([see page 10](#)) provided that time updates from the network were selected.

Should you need to set the time manually, change the time zone, or manually switch from winter to summer time (from GMT to BST in the UK, also commonly known outside the UK as daylight savings time), then please follow this procedure.

1. With your radio switched on, press **Menu**.
2. Choose 'System Settings'.
3. To change the current time or date setting choose 'Time/Date', 'Set Time/Date', and then set the correct day, month, year, hour and minute digits.

To change the time zone setting go to step 5.

To change from winter to summer time go to step 6.

4. The display will then return to the previous menu.
5. Select 'Set Timezone' and choose the time zone which is applicable to your location.
6. Select 'Daylight Savings'. The asterisk shows the current setting.

In the UK, ON is equivalent to British Summer Time, OFF is equivalent to Greenwich Mean Time.

Note: This option is only available for Network Time updates.

7. Choose 'ON' or 'OFF' as required. Press **Menu** to exit.

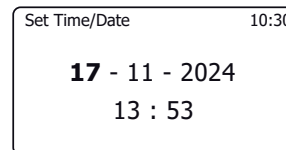
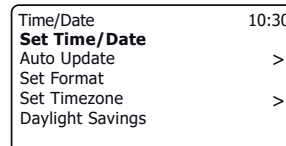
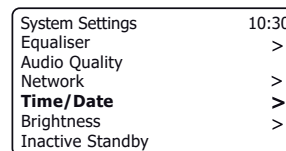
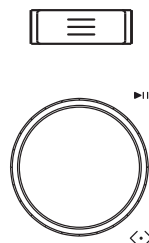

Setting the alarm clock

Your radio has two separate alarms which can be set to wake you to either the radio or a buzzer alarm. The alarms can only be used when the radio is powered from the mains or when you have the optional battery pack installed.

Alarms may be set while the radio is in standby mode or switched on. In the event of a power interruption your radio will retain your alarm settings. Ensure that the time is set correctly before setting the alarms.

1. To change the states of the alarms while the radio is in *Standby* press the **Alarm** button. With each press the display will cycle through No Alarm, Alarm 1 enabled, Alarm 2 enabled, or Alarms 1 and 2 enabled.
2. To change the alarm settings while the radio is in Standby, **apply a long press** on the **Alarm** button. This will cause the Alarms menu to be displayed. Then skip to step 5 below.
3. To change the alarm settings while the radio is switched on, either press and release the **Alarm** button and then skip to step 5 below, or alternatively press **Menu**. Choose 'Alarms'.
4. The current alarm settings will be displayed. If no change is required, press the **Menu** button to exit.
5. Choose alarm 1 or 2 as needed.
6. Choose 'Time' and then choose the alarm hour and then the alarm minute. If the radio has been set to use a 12 hour clock format, there will also be an option here for setting AM or PM for the alarm time.
7. The display will then return to the alarm setting menu.
8. Choose 'Enable'. The display will show the Frequency options for the alarm. The alarm frequency options are as follows:

'Off' - the alarm will be disabled

'Daily' - the alarm will sound everyday

'Once' - the alarm will sound once

'Weekends' - the alarm will sound only at weekends

'Weekdays' - the alarm will sound on weekdays only

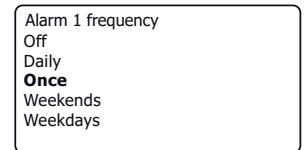
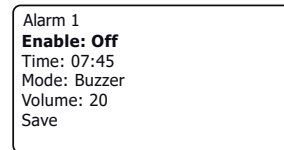
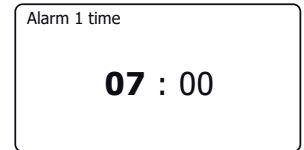
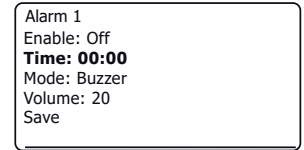
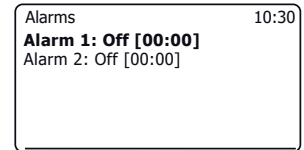
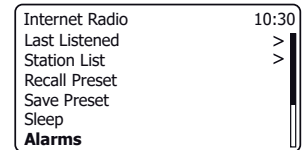
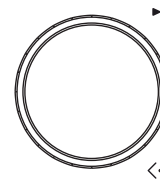
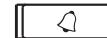

Setting the alarm clock - cont.

9. Choose the alarm frequency option. Choosing 'Off' will disable the alarm.
If you choose to set the alarm to Once you will also need to set the date.
10. The alarm can be set to buzzer, Internet radio, DAB radio or FM radio. For whichever radio mode is selected, the radio alarm may be set to any of the stations which have been stored as presets or to the station most recently listened to.
Choose the 'Mode' option for the alarm either 'Buzzer' or the required radio mode.
11. If setting the alarm to a radio option, choose the 'Preset' option.
Choose from either the radio station 'Last Listened' to, or from the list of presets. Scroll to the chosen option and press the control to confirm the selection.
Note: The alarm may only use a preset which has already been stored.
12. Choose the 'Volume' option. The radio uses the saved volume setting for each alarm when it sounds. Use the **Tuning** control to set the required volume setting.
13. In order to store the alarm settings select the 'Save' option. Press **Tuning**. Your radio will show 'Alarm Saved' and will then go back to the list of alarms with the new alarm setting shown in the display.

If you decide not to save the settings, press **Menu**. The display will show 'Save changes' with a 'YES' or 'NO' option. Choose 'NO'. 'Alarm not saved' will show on the display. Active alarms are shown using small alarm indicators on the playing displays and on the clock display when in Standby. **Note:** If you make a mistake, use the **Menu** button to go back to the previous screen.

When the alarm sounds

The buzzer or radio alarm will sound at the selected times for up to 60 minutes unless cancelled. The volume used for the alarm will be as specified during the alarm setting procedure. If the radio cannot receive the specified DAB radio station, the buzzer alarm will be used instead.

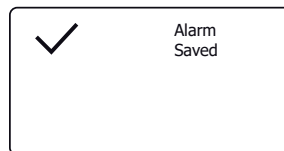
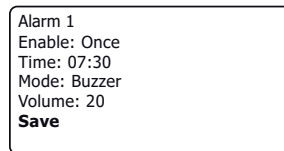
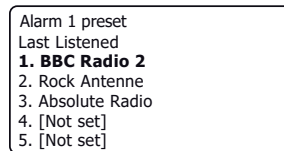
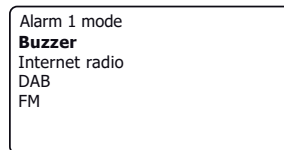
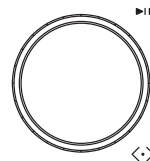

When the alarm sounds cont.

1. During an alarm, the alarm icon will flash on the display. The radio will automatically revert to standby mode after 60 minutes.
2. The radio volume may be adjusted as needed using the **Volume** control.
3. To cancel an alarm, press **On/Off** to return to Standby mode.

Note: If the radio is switched on because of an alarm you can control basic functions such as volume but you cannot perform operations which involve the **Tuning/Select** control since this also acts as the Snooze (see below).

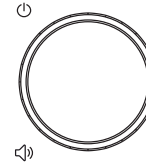

Snooze timer

1. The buzzer or radio alarm can be silenced for 5 minutes by pressing the **Tuning/Select/Snooze** control. Should you wish for a longer snooze duration this can be extended. Pressing the control again while the radio is snoozed will set the available snooze time to 5, 10, 15 or 30 minutes.
2. While the snooze timer is active the remaining snooze time is shown next to the flashing alarm icon on the clock display.
3. In order to cancel the Snooze timer while the alarm is suspended, press **On/Off**. The display will briefly show an 'Alarm Off' message.

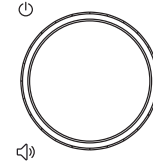
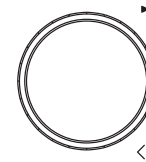

Disabling alarms

1. To disable an alarm while the radio is in standby mode press and release the **Alarm** button to cycle through the [alarm on-off options \(see page 38, step 1\)](#).
2. To disable an alarm while the radio is playing enter the Alarms menu ([see page 38, steps 3 and 4](#)) and select alarm (1 or 2).
3. Choose 'Enable' and choose the 'Off' option.
4. Choose the 'Save' option and press **Tuning** to save the new setting.
The chosen alarm will now be disabled.

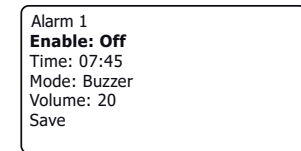
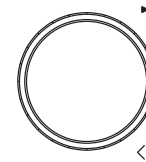

Sleep timer

Your radio can be set to turn off after a preset time has elapsed. The sleep timer can be adjusted between 15 and 120 minutes.

1. Press **On/Off** to switch on the radio and choose the desired mode of operation.
2. With the radio playing, apply a **long press** on the **On/Off control** to display the sleep timer options.
3. Rotate and press the **Tuning** control to choose the required sleep time setting. The sleep timer can be set to between 15 and 120 minutes, or to Off.
4. To set the sleep time using the menu, press **Menu** and then choose 'Sleep' and the required sleep time. Press **Tuning** to confirm the setting.
5. Your radio will switch into Standby mode after the preset time has elapsed. If running on batteries it will switch off completely shortly afterwards.
6. An active sleep timer is shown using a small timer indicator at the bottom of the playing displays. This indicator also shows the sleep time remaining before the radio switches itself into Standby mode.
7. To cancel the sleep time before the preset time has elapsed and to turn off the radio, press **On/Off** to turn the radio off manually.
8. To cancel the sleep timer and leave the radio playing, go back into the sleep timer settings (steps 2 to 3 above) and select the 'Off' option in step 3.

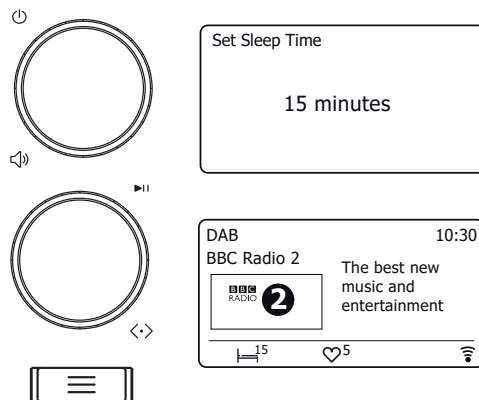

Equaliser function

The sound on your radio can be adjusted to suit your personal taste for the material that you are listening to. The Rambler Max has a range of equaliser options. Alternatively you may set the treble and bass levels to your own preferences which can be accessed from the *My EQ* menu item.

1. With your radio switched on, press **Menu**.
2. Choose '*System Settings*', '*Equaliser*' and then cycle through and highlight the various option. Press **Tuning** to confirm your selection.

'Normal', 'Classic', 'Jazz', 'Pop', 'Rock', 'News', 'My EQ'

The currently selected option is marked with an asterisk.

3. Alternatively the Equaliser menu may be accessed by pressing the **Mode** button and then using the **Tuning** control to select the Equaliser function from the Mode icons display.

Setting up your My EQ profile

If you find the preset equaliser functions not to your liking, you may set up a custom treble and bass setting as follows:

1. Follow steps above in order to enter the Equaliser menu.
2. Choose '*My EQ profile setup*' then '*Bass or Treble*'.
3. Choose the desired level (between -8 and +8). The sound will change as you turn the tuning control. Press the control when you are happy with the bass or treble setting.
4. Press **Menu as needed** and the display will prompt you to save the changes. If you wish to save the changes choose '*YES*'. If you do not wish to save the changes choose '*NO*'. Press **Tuning**.
5. To use the '*My EQ*' profile choose '*My EQ*'.

To quickly cancel the effect of the '*My EQ*' profile choose '*Normal*'.

The treble and bass settings will be remembered for the next time that you wish to use the '*My EQ*' setting.

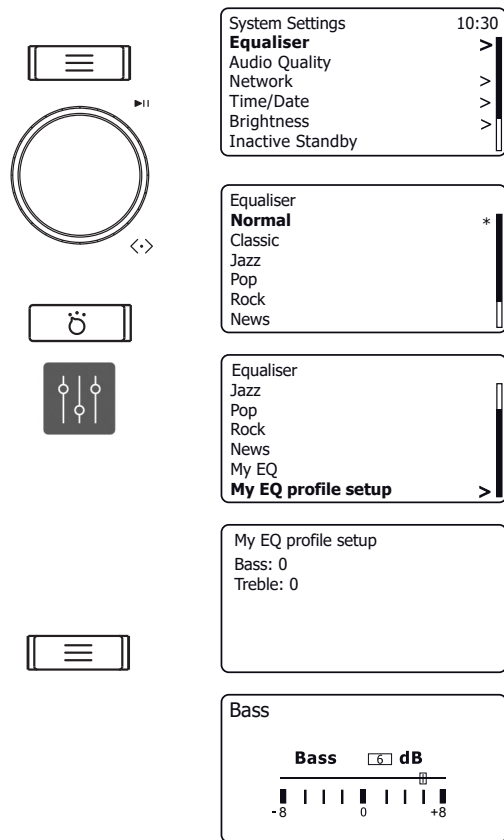

Brightness control

The brightness of the display can be adjusted for when the radio is in standby and for when it is in use. If you use the unit in the bedroom, you may prefer a lower standby brightness level than the standard setting.

There are 4 standby brightness levels and 3 levels for when the radio is in use. To change the current brightness setting please follow these steps.

1. With the radio in standby or in use apply a **long press** on the **Info** button.
Alternatively, while the radio is in use you may also press **Menu** and choose 'System Settings' then 'Brightness' to access the display brightness setting.
2. To adjust the display brightness when the radio is switched on select the 'Power-on level'.
To adjust the display brightness when the radio is in standby select the 'Standby level'.
The display brightness will change while you change the highlighted option. Then press **Tuning**. The current setting will be marked with an asterisk.
3. Choose either the 'High', 'Medium' or 'Low' setting. If setting the standby brightness level there is also an option to set the brightness to 'Very low'. Press the **Tuning** control to set the level. If the radio is playing, then the chosen brightness will be applied immediately. If the radio is in standby, then the chosen brightness will be applied after a few seconds delay.

When the radio is in Standby mode and powered by the mains, pressing a button or turning a rotary control will cause the radio to switch a higher brightness level for a few seconds. This is so that even if the standby brightness level is set very low, it is still possible to see the time when needed.

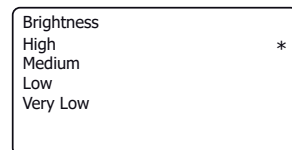
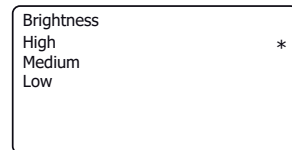
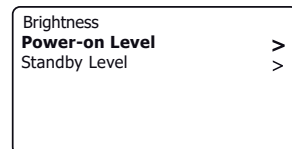
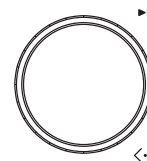
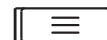
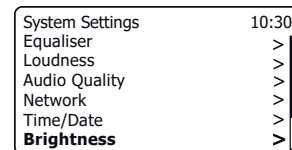

Headphone socket

A 3.5mm **Headphone Socket** is located on the underside of your radio. Inserting a plug automatically mutes the internal loudspeaker. Please be aware that the sensitivity of headphones can vary widely. We therefore recommend setting volume to a low level before connecting headphones to the radio.

IMPORTANT: Excessive sound pressure from earphones and headphones can cause hearing loss.



To prevent possible hearing damage, do not listen at high volume levels for long periods.

Auxiliary input socket

A 3.5mm **Auxiliary Input** socket located on the underside of your radio for connecting the audio signal from an external audio source such as an MP3 or CD player.

1. Connect a stereo lead from the headphone output of your MP3 or CD player to the Aux In socket located under the radio. Typically this lead will have a 3.5mm stereo plug at both ends.
2. Switch on your radio and press the **Mode** button until 'Aux In' mode is shown on the display.
3. Press 'play' on the connected audio device. If you are using its headphone output for the connection, set its volume control to a level of somewhere between two-thirds and maximum (the objective is to get a strong audio signal but without too much distortion). Then adjust the volume on the radio as required.
4. After use, disconnect your player in order to listen to your radio conventionally.

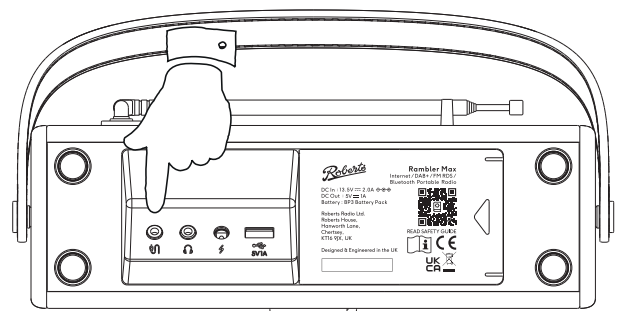
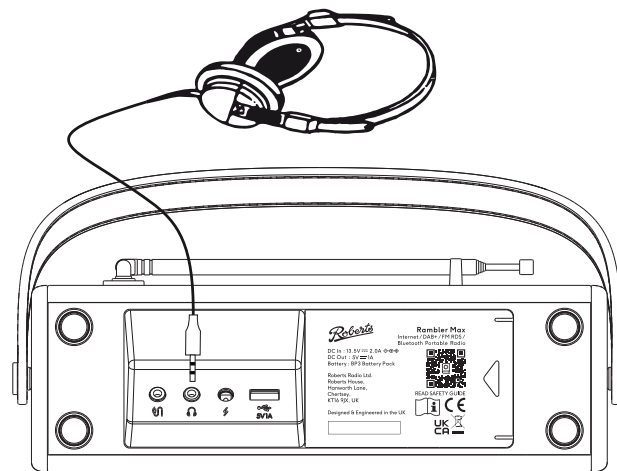

Inactive Standby feature

The Inactive Standby timer allows your radio to save power by automatically going to Standby if no controls are used for a period of time. By default this period is set to 8 hours but you may change it if you wish.

1. With your radio switched on, Press **Menu**.
2. Choose 'System Settings'.
3. Choose 'Inactive Standby' and then choose from 2, 4, 6, 8 hours or Off.
4. Your radio will go into standby after the selected time has expired. Setting Inactive Standby to Off will disable this feature.

Your radio may also enter standby mode if no radio or audio signal is received for 15 minutes in order to minimise power consumption.

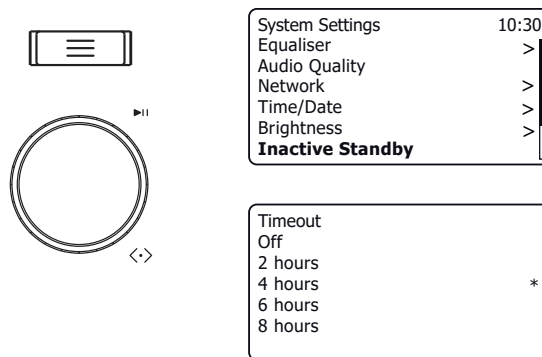

USB socket for smartphone or tablet charging

Your radio has a USB socket which can be used for charging a smartphone, tablet or other similar devices.

Charge time may vary and in some cases may take longer to charge than when using the manufacturers charging unit supplied with the device.

1. Ensure your radio is plugged in and powered from the mains.
2. Connect your device to the USB charging socket on the underside of your radio.
3. Your device will begin to charge. Once your device has charged remove the USB lead.

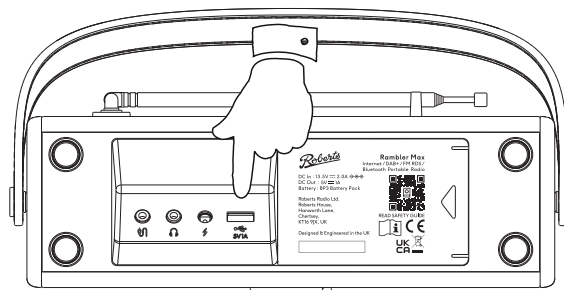

Using the Oktiv app

Download and install the Oktiv app on to your Android or iOS device.

If you have already have an older Roberts Smart Radio which uses the UNDOK app, you may prefer to continue using that app instead, although you would not then have access to the newer features provide by Oktiv. At the time of writing, Oktiv does not support older Roberts Smart Radios.

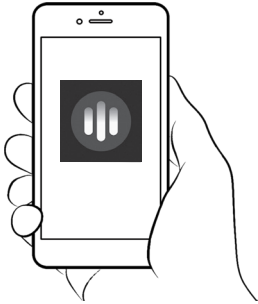

- iOS - Download from Apple App Store
- Android™ - Download from Google Play

There may be more than one app called Oktiv. The app needed is OKTIV from Frontier Smart Technologies, which has the logo as shown on the left.

Note: At the time of writing a device using Android version 8.0 or later, or iOS version 13.0 or later, is required to use Oktiv.



If you already have the Oktiv app installed on your device ensure that you have the latest version.

1. Ensure the radio is active and connected to the same WiFi router as your smart device.
2. Launch Oktiv and select your device from the Discover screen.
3. To connect to a different device select '*Settings*' - '*Connected audio devices*' - '*Add Connected audio*', and then select your device from the Discover screen.
4. You can now use Oktiv to control many of the functions of your radio remotely, including changing the mode (use), searching for stations, adding and selecting presets, searching a USB device, and controlling the volume.

Please refer to the developer's website for guidance on how to use the latest version - <https://support.oktiv.app>



Using the BP3 rechargeable battery pack accessory

Inserting the battery pack

1. Hold the radio with the base uppermost and disconnect the radio from the mains adaptor.
2. Slide the battery cover located underneath the unit in the direction of the arrow and lift upwards to open the battery compartment.
3. Note the orientation of the battery and cable in the diagram. Carefully bend the cable as shown then insert the plug into the socket in the battery compartment.
4. Position the end of the battery furthest from the plug into the compartment.
5. Lower the battery fully into the compartment so that its cable sits in the channel beneath the battery.
6. Lower the battery cover fully and then slide it back so that it latches in the closed position.
7. Reconnect the mains adaptor to the DC input socket under the radio and place the radio upright for use.
8. With the battery installed, a battery status indicator is shown on the display whenever the radio is in use. This will indicate the battery level, and will also show when the battery is being charged.

Removing the battery pack

If the radio is not to be used for an extended period of time it is recommended that the battery pack is removed from the radio after giving it a charge. It should then be stored in a cool, dry place until needed, out of reach from children. Avoid storing the battery in a completely discharged state, since this will shorten its working life.

1. To remove the battery pack, disconnect the radio from the mains adaptor and open the battery compartment.
2. Carefully remove the battery. To unplug the cable, hold the cable near the plug and pull gently while rocking the cable slightly side to side. **Do not pull on the plug by holding only the battery.**

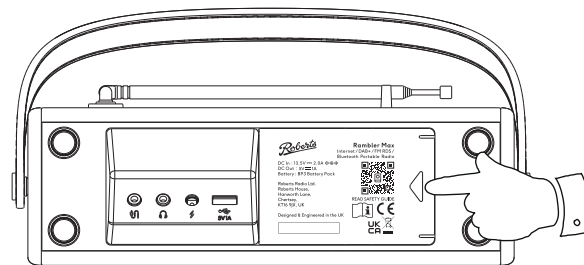

Position of the battery cable and plug when being inserted into the battery compartment.

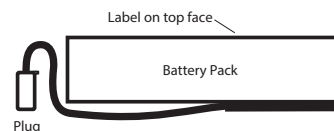

Important: Be sure to read the safety notices in the leaflet supplied with the battery pack. This leaflet also describes how to dispose of the pack safely when it is at the end of its working life.



Information

Factory reset

If you wish to completely reset your radio to its initial state this may be performed by following this procedure. By performing a factory reset, all user entered settings will be erased.

1. With your radio switched on, Press **Menu**.
2. Choose 'System settings', 'Factory Reset' and then 'YES' to proceed.
If you do not wish to carry out a system reset, highlight 'NO' and then press the control. The display will revert to the previous menu.
3. With 'YES' highlighted, press **Tuning**. A full reset will be performed and the radio will restart as if first plugged in. The DAB stations list together with any preset stations will be erased and your WiFi network connection details will be lost. All configuration settings will be restored to their defaults, the clock and alarms will be reset.

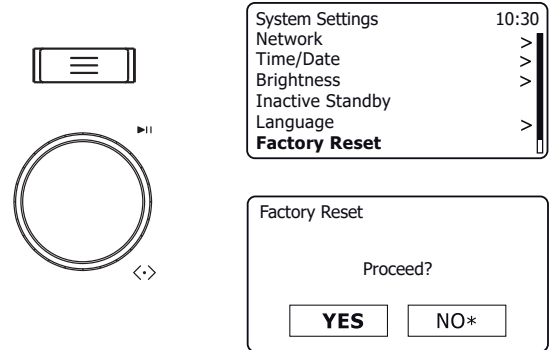

Electro-magnetic compatibility advice

In the event of a malfunction due to electrostatic discharge, mains power supply transients or short interruptions, reset the product as above to resume normal operation. If you are not able to perform the reset operation as above, removal and reconnection of the power supply and battery pack may be required.

If the product is used in an environment with any ESD Immunity / Radiated Immunity / Conducted Immunity disturbance, the product may malfunction. It will automatically recover to normal when the ESD Immunity / Radiated Immunity / Conducted Immunity disturbance is stopped.

Product markings

	DC Voltage Power input 13.5V / 2.0A USB output 5V / 1A
	Recycling This product bears the selective sorting symbol for Waste Electrical and Electronic Equipment (WEEE). This means that this product must be handled pursuant to European directive 2012/19/EU in order to be recycled or dismantled to minimize its impact on the environment. The user has the choice to give the product to a competent recycling organization or to the retailer when buying a new electrical or electronic equipment.



Software update

Your radio has been designed to allow its internal software to be updated using your Internet connection. You should not attempt to update your radio unless it is recommended to you by Roberts Customer Services. Updating the software may remove all network settings, radio station presets and alarm settings from your radio. It is important that you do not attempt this procedure unless you have a good Internet connection and a reliable mains power supply. The radio connects to your router using a WiFi connection, make sure that this is also reliable before proceeding.

1. The '**Software update**' option is accessed via the System Settings menu. When you select '**Software Update**' the menu will display '**Auto check setting**' and '**Check now**'. If you want your radio to check periodically for new software versions choose '**Auto check settings**' and then choose '**YES**'. If you do not want your radio to check for updates choose '**NO**'.
2. To check if there are any software updates available currently, choose '**Check now**'. The radio will check to see if an update is available. The display will show '**Checking for new versions**'. If there are no updates then the display will show '**Software up to date**'. If a software update is available your radio will then offer the choice of updating the software or not, displaying '**New version available. Update software?**'. Select the '**YES**' option if you wish to go through the update process. If you choose to update your radio it will first download the new software and will then reprogram its internal memory. This may take anything from a few seconds to a few minutes depending on the speed of your internet connection.
3. Once the software update is completed, the radio will prompt you to press **Select** to restart. Press **Tuning** and your radio will then restart. You may find that you will need to reconfigure your network connection following an update. You may also need to re-enter all radio station presets, alarm settings, and configuration options.

VERY IMPORTANT: Do not switch off the power to the radio until the update operation is complete and the radio has restarted, otherwise the unit may become permanently damaged.

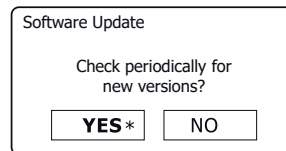
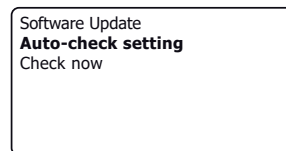
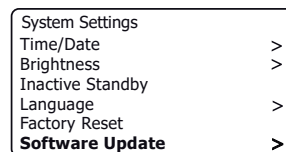

Network profiles

Each time that you connect your radio to a WiFi network, the radio will store the details of that connection (SSID, security key, DHCP/IP address settings) as a profile. Up to four such profiles are stored in the radio so that if the unit is used in multiple locations there is no need to enter the network settings when returning to a location previously visited. The radio stores the four most recent profiles in memory identified by their SSID. Normally the radio will attempt to connect to one of the stored profiles and only if it is unable to do so will you need to use the [Network Wizard \(see page 11\)](#).

In the event that you visit a location only once you may wish to delete the profile for the network in that location to avoid losing other profiles.

1. Press **Menu**. Choose '**System Settings**', '**Network**' and then '**Network Profile**'. Press **Tuning** to see the stored profiles. The profile which is currently in use (if any) is marked with an asterisk.
2. To remove a profile from memory, rotate **Tuning** to highlight the profile to be deleted and then press the control. The radio will offer a '**YES**' or '**NO**' selection. Choose '**YES**'. The selected profile will be deleted. Note that it is not possible to delete a profile which is currently in use.



Software version display

A display showing the software versions and other information is provided for reference and customer support purposes.

1. Press **Menu**. Choose 'System Settings' and then 'Info'. The display will show the software version and radio ID. Rotate **Tuning** to display further information.
2. Press **Menu** to exit.

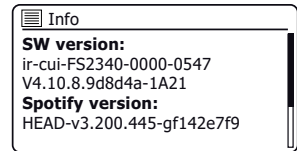
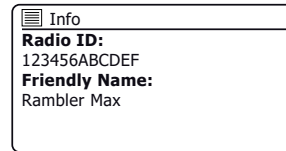

Friendly name

Your radio uses a Friendly Name so that it is identifiable within remote control software such as the Oktiv app, on devices with Bluetooth, and in connected apps such as Spotify. By default, your radio's Friendly Name will be shown as "Rambler Max". If you would like to change this name to something more personalised you may either use the Oktiv app ('Settings' - 'Connected audio devices') or follow the instructions below.

1. Press **Menu** and choose 'System Settings', 'Network' and then 'View Settings'. The current network settings will be displayed.
2. Rotate **Tuning** until the IP address is showing on the display. This is the local IP address used by your radio on your network. In the example screen to the right the IP address is 192.168.1.27. Make a note of the IP address shown on your radio's display for the next stage.
3. Ensure that your device with a web browser is on the same network as the radio. Enter the IP address noted above into the address bar of your web browser. For example, enter 192.168.1.27 followed by Return. This will allow you to view some of the radios settings and will allow you to change the friendly name. Type the new name in the box as shown and then click **'Apply'** to save the name. The new Friendly Name will now be visible to network connected devices.

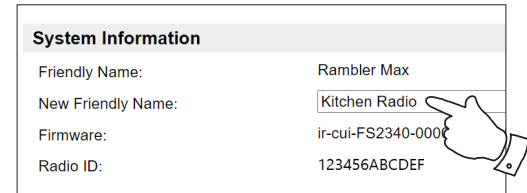
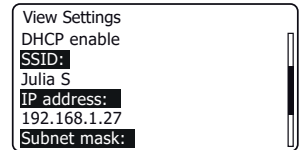

Troubleshooting

If you experience any trouble with your radio, then you may find it useful to visit the help section on our web site.

If you have difficulty connecting the radio to your computer network, some of these steps may help to resolve the problem:

1. Confirm that a WiFi connected PC can access the Internet (i.e. can browse the web) using the same network.
2. Check that other devices can be connected to your router. Your radio will by default use the method known as DHCP for this unless you choose to disable it. This may be configured using the menu items '*System settings*' -> '*Network*' -> '*Manual settings*'. This will ask you to configure a wireless connection. You then need to choose '*DHCP enable*' or '*DHCP disable*'. If you enable DHCP then the radio will negotiate with your router (or DHCP server) and will be provided with an IP address as well as the other settings needed. If you wish to set the network configuration manually, refer to paragraph 6.
3. Check that your network's firewall is not blocking any outgoing ports. As a minimum, the radio needs access to UDP and TCP ports 80 and 123. Some Internet radio services may require additional ports to be open, but this is not common.
4. Check that your router does not restrict connections to particular MAC addresses (sometimes called MAC address filtering).

You can view the radio's MAC address using the menu items '*System Settings*' -> '*Network*' -> '*View Settings*' -> '*MAC address*'.

The MAC address will typically be of the form

4C : 09 : FA : xx : xx : xx

5. If you have an encrypted network (which would normally be the case), check that you have entered the correct encryption key into the radio. Remember that text-format WPA keys are case sensitive. If your radio displays '*Network error*' when attempting to connect to an encrypted network, then please ensure that you enter the correct key for the network. If the problem persists, then you may need to re-check your network configuration.
6. If you need to set up your radio's IP address manually, you will need to know low-level details of your network's configuration. Use the menu items '*System Settings*' -> '*Network*' -> '*Manual settings*' -> '*Wireless*' -> '*DHCP disable*'.

The radio will then prompt you in turn for the

IP address
Subnet mask
Gateway address
Primary DNS
Secondary DNS

If you are setting up a WiFi connection manually you will also need to enter the SSID, the encryption type, and the encryption key.

[See page 16 for full details on how to set up your radio's network configuration manually.](#)



Troubleshooting - cont.

If your radio can connect to the network, but is unable to play a particular Internet radio station, it may be due to one these causes:

1. The station is not broadcasting at this time of the day.
2. The station has reached its maximum allowed number of simultaneous connections.
3. The Internet connection between your radio and the server (often located in a different country) is slow. This could be due to internet congestion, either locally or at a distance.
4. The station may choose to block internet connections to your geographic region (sometimes known as geo-locking).
5. The station is no longer broadcasting. The database of radio stations that your radio connects to is frequently updated and checked but may not always be completely accurate.
6. The radio station is broadcasting using an audio format which is not playable by your radio.

Try using a computer or phone to listen via the broadcaster's web site. If you can play the station with another device, it may be that the internet feed or local network connection is poor. However, some broadcasters (such as the BBC) provide different data streams for mobile users and Internet radio listeners, so this test is not always conclusive.

If you cannot play the station via your device this may indicate that the problem is not necessarily due to your radio, but it could be your network, your internet connection, the broadcaster, or internet congestion.



Cautions

Do not allow your radio to be exposed to water, steam or sand.
Do not leave your radio where excessive heat could cause damage.
The name plate is located underneath the radio.



- Use only the mains adaptor provided with the product, or a genuine replacement provided by Roberts Radio. The use of alternative adaptors will invalidate the guarantee.



IMPORTANT: The optional battery pack should not be exposed to excessive heat such as sunshine, fire or the like. After use, the battery pack should be taken to a suitable recycling centre. On no account should the battery pack be disposed of by incineration or in general refuse.

Please handle the radio with care. The leather-cloth finish may be susceptible to damage if mistreated. Avoid all contact with any abrasive material, chemical substances or cleaning solutions. Your radio may be wiped with a clean lightly damp cloth. **Please ensure that the product is unplugged from the mains socket outlet before attempting this procedure.**

- The mains adaptor and radio shall not be exposed to dripping or splashing and no objects filled with liquids, such as vases, shall be placed on the mains adaptor or the radio.
- It is recommended to operate the product such that there is a minimum distance (10cm recommended) to adjacent objects in order to ensure good ventilation.
- The ventilation of the product should not be restricted by covering it with items such as newspapers, tablecloths, curtains etc.
- No naked flame sources such as lighted candles should be placed on the product.
- It is recommended to avoid using or storing the product at extremes of temperature. Avoid leaving the unit in cars, on window sills, in direct sunlight etc.
- The mains adaptor and radio must be used in a moderate climate.
- There are no user serviceable parts inside this product.
- Do not attempt to disassemble any part of the product.
- To maintain the compliance with the WiFi RF exposure requirement, place the product at least 20 cm (8 inches) from nearby persons except when operating the controls.



Specifications

Power Requirements

Mains Adaptor 100 - 240 volts \sim 50/60hz
(use only supplied adaptor)

Battery Pack Roberts BP3 rechargeable pack
(not included)

Battery Life Approximately 8 - 10 hours depending
upon volume, display brightness and
operating mode.

Connectivity

WiFi 802.11 b, g, n or a supported with WEP
and WPA / WPA2 encryption

Compatible with 2.4 GHz and 5 GHz WiFi bands.

5 GHz Wi-Fi function: 5150 - 5350MHz
5470 - 5725MHz
5725 - 5875MHz

2.4GHz WiFi EIRP power (max.) 15.91dBm

5GHz WiFi EIRP power (max.) 17.37dBm

Usage restriction: This device is authorised in the following countries for
indoor use only when used with 5GHz Wi-Fi (5150 to 5350MHz; channels
36 to 64):



AT	BE	BG	CH	CY	CZ	DE
DK	EE	EL	ES	FI	FR	HR
HU	IE	IS	IT	LI	LT	LU
LV	MT	NL	NO	PL	PT	RO
RS	SE	SI	SK	TR	UK(NI)	

Headphone socket 3.5mm diameter, stereo
Aux In socket 3.5mm diameter, stereo

Aerial System WiFi Built-in antenna
DAB/FM Telescopic aerial

Frequency Coverage

FM 87.5 - 108MHz
DAB 174.928 - 239.200MHz

Bluetooth 4.2 frequencies 2.402 - 2.480GHz

Bluetooth EIRP power (max.) 6.66dBm

Bluetooth standards A2DP, AVRCP

Bluetooth codecs supported SBC

Operating temperature range +5°C to +40°C

The Company reserves the right to amend the specification without notice.



Software license information

Use of the software in this radio is subject to software licence terms contained in this user manual - by using the radio, you are agreeing to comply with these licence terms:

Thompson Licensing: MP3 audio decoder

MPEG Layer-3 audio coding technology licensed from Fraunhofer IIS and Thomson

Fraunhofer: MPEG-4 HE AAC Audio decoder

MPEG-4 HE-AAC audio coding technology licensed by Fraunhofer IIS:

<http://www.iis.fraunhofer.de/amm/>



Spotify: Spotify Connect

The Spotify software is subject to third party licenses found here:

<http://www.spotify.com/connect/third-party-licenses>



Notes



Guarantee

This product is guaranteed for twenty-four months from the date of purchase by the original owner against failure due to faulty workmanship or component breakdown, subject to the procedure stated below. Should any component or part fail during this guarantee period it will be repaired or replaced free of charge.

The guarantee does not cover:

1. Damage resulting from incorrect use.
2. Consequential damage.
3. Product with removed or defaced serial numbers.

N.B. Damaged or broken telescopic aerials will not be replaced under guarantee.

Procedure:

Any claim under this guarantee should be made through the dealer from whom the product was purchased. It is likely that your Roberts' dealer will be able to attend to any defect quickly and efficiently, but should it be necessary the dealer will return the product to the company's service department for attention. In the event that it is not possible to return the product to the Roberts dealer from whom it was purchased, please contact Roberts Radio using the contact details on the www.robertsradio.com website.

For product repairs falling outside the guarantee period, please refer to the "Customer care" tab on the www.robertsradio.com website.

These statements do not affect the statutory rights of a consumer.

Designed & Engineered in the UK

ROBERTS RADIO LIMITED

Roberts Radio Ltd, Roberts House, Hanworth Lane, Chertsey, Surrey, KT16 9JX, UK
Glen Dimplex Europe Ltd, Airport Road, Cloghran, Co. Dublin, K67 VE08, Ireland

www.robertsradio.com

© 2024 Roberts Radio Limited



Issue 1

October 2024

