

# ROBERTS

Sound for Generations

## RD-55

FM RDS/DAB Digital Portable Radio  
with SD/USB/One touch record

*Gemini 55*



### DAB

Digital Audio Broadcasting

Please read this manual before use

## Contents

Controls .....	2-5	Using an SD Memory card with your radio .....	23
Battery operation .....	6	Recording a radio program - DAB only .....	23
Mains operation .....	7	SD card format .....	24
Operation modes .....	8	View file space.....	25
Operating your radio - DAB .....	9	File playback .....	26-27
Selecting a station - DAB .....	10	Delete files.....	28
Presetting stations.....	11	USB connection.....	29
Finding new stations - DAB .....	12	FM Stereo/Mono.....	31
Manual tuning - DAB .....	12	Software version.....	31
Operating your radio - search tuning FM.....	13	Signal strength display - DAB.....	32
Manual tuning - FM .....	14	System reset .....	33
Secondary services - DAB .....	15	Auxiliary in socket.....	34
Display modes - DAB .....	16	Line out socket .....	34
Display modes - FM.....	17	Headphone socket .....	34
Using your radios PausePlus feature .....	18	Sound switch .....	35
Dynamic range control (DRC) .....	20	Display backlight .....	35
Station order setup - DAB .....	21	General.....	36
Favourite station order .....	21	Specifications .....	37
Alphanumeric station order .....	21	Guarantee .....	38
Active station order .....	21		
Prune stations .....	22		

## Controls

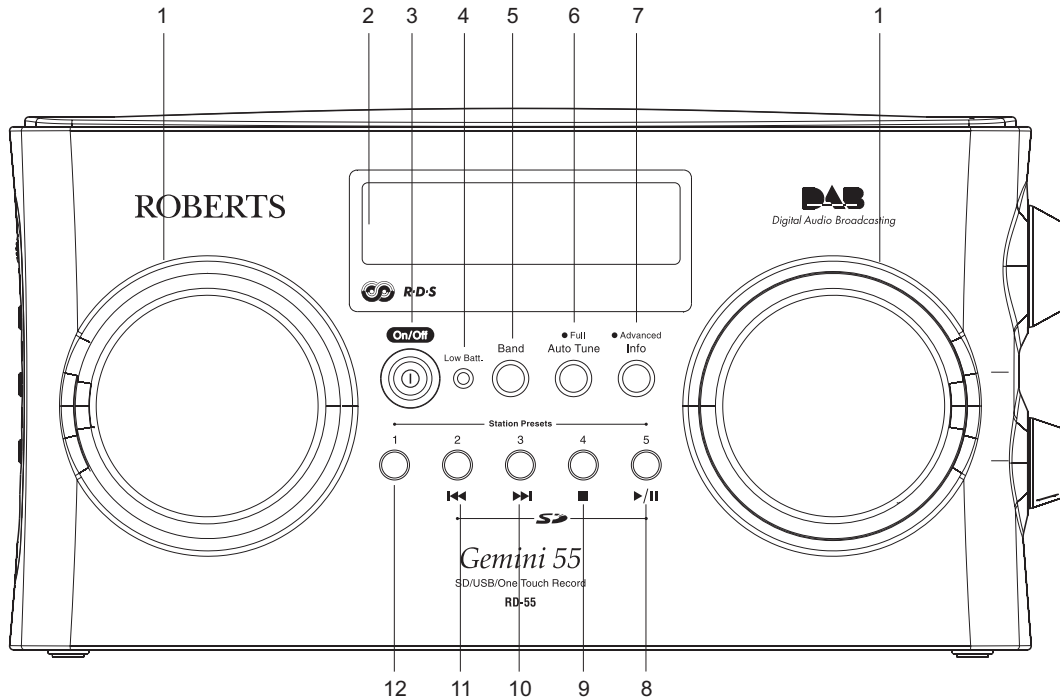

1. Speakers
2. LCD display
3. On/Off button
4. Low battery indicator

5. Band button
6. Auto tune button
7. Advanced information button
8. Preset 5/Play/pause button

9. Preset 4/Stop button
10. Preset 3/Fastforward button
11. Preset 2/Rewind button
12. Preset 1 button

If you need any further advice, please call our Technical Helpline on :-  
020 8758 0338 (Mon-Fri)

## Controls (rear)

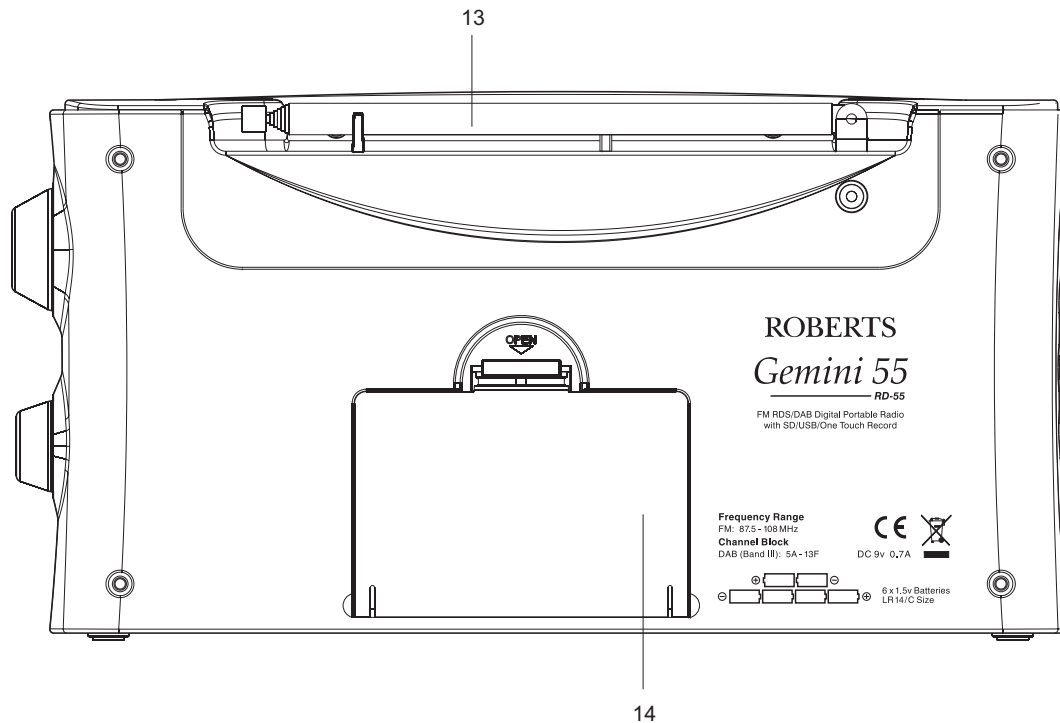

13. Telescopic aerial

14. Battery compartment

## Controls

Left hand side

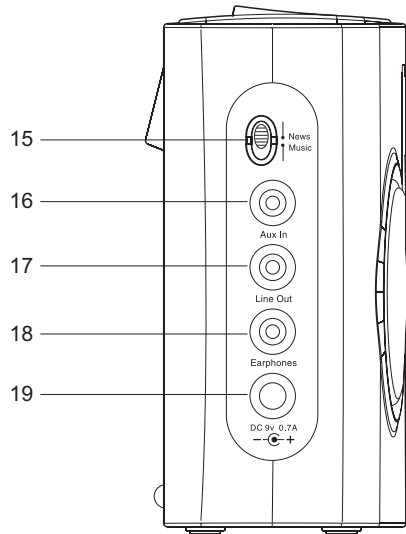

- 15. Sound switch
- 16. Auxiliary in socket
- 17. Line out socket
- 18. Earphone socket

Right hand side

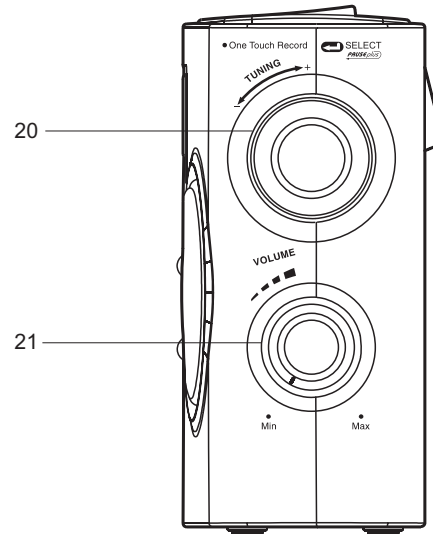

- 19. DC input socket
- 20. Tuning/Record control
- 21. Volume control

## Controls (Top)

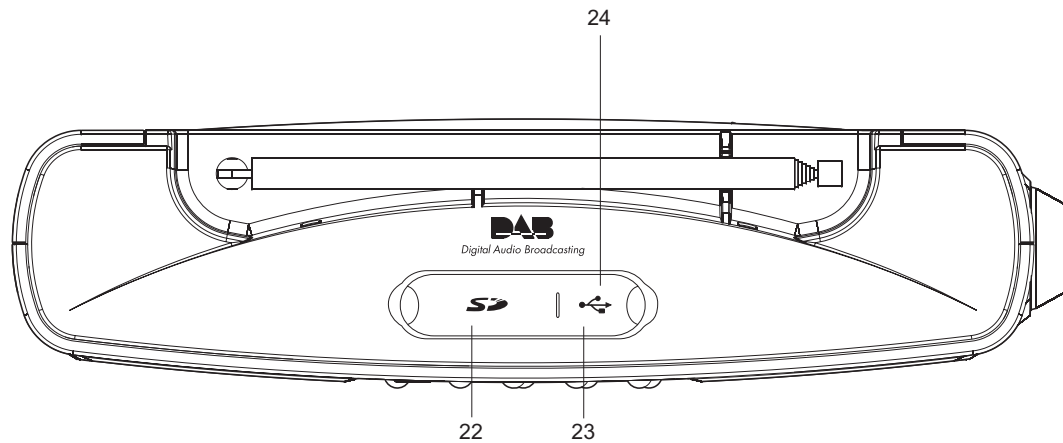

- 22. SD card slot
- 23. USB socket
- 24. Rubber cover

## Battery operation

1. Remove the **Battery cover** on the rear of the unit by pushing the catch downwards. Open the battery door.
2. Insert six LR14 (C size) batteries into the spaces in the compartment. Take care to ensure all batteries are inserted with the correct polarity as shown on the rear of your radio. Close the battery door.
3. When the battery drops below a certain level the low battery indicator will light. When you see this indicator you should change the batteries as soon as it is convenient to do so. Reduced power, distortion and a 'stuttering' sound are also signs that the batteries may need replacing.
4. If the radio is not to be used for any extended period of time it is recommended that the batteries are removed from the radio.

We would recommend for economy that the RD-55 is used via the mains adaptor whenever possible with battery operation for occasional or stand-by use only.

**IMPORTANT:** The batteries should not be exposed to excessive heat such as sunshine, fire or the like. After use, disposable batteries should if possible be taken to a suitable recycling centre. On no account should batteries be disposed of by incineration.

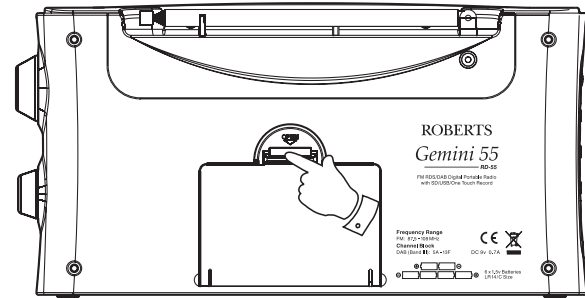

## Using the AC adaptor

Your radio is supplied with a Mains Adaptor.

1. Place your radio on a flat surface.
2. Insert the adaptor plug into the DC socket located on the left hand end of your radio.
3. Plug the adaptor into a standard 13 amp mains socket outlet. Whenever the adaptor is used, the batteries are automatically disconnected.

*The AC adaptor should be disconnected from the mains supply and the radio when not in use.*

- **IMPORTANT:** The mains adaptor is used as the means of connecting the radio to the mains supply. The mains socket used for the radio must remain accessible during normal use. In order to disconnect the radio from the mains completely, the mains adaptor should be removed from the mains socket outlet completely.

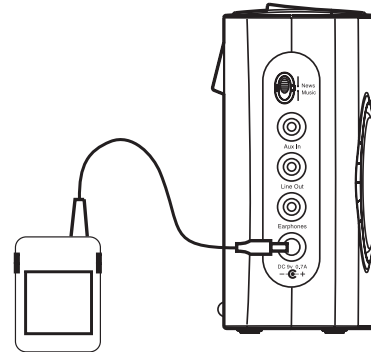



## Operation modes

Your radio has 4 operation modes, DAB, FM, Playlist mode and Auxiliary input.

1. Press the **Band button** to change the operation mode between DAB, FM, Playlist and Auxiliary input mode.
- DAB mode is used for listening to Digital Radio broadcasts and for recording programmes to a memory card.
  - FM mode is used for listening to FM radio broadcasts.
  - Playlist mode is used to play back digitally recorded programmes and for listening to MP2 and MP3 files.
  - The RD55 has a Auxiliary input socket which can be used as an amplifier and loudspeaker system for external MP3 players, mini disc players and similar devices.

Band



BBC 7  
Just a Minute...

FM 89.30 MHz

Play track  
◆ DAB000.MP2 ◆

AUX IN

## Operating your radio - DAB

1. Carefully extend the telescopic aerial.
2. Press the **On/Off button** to switch on your radio. The display will show "Roberts" for a few seconds.
3. If this is the first time the radio is used a quick scan of UK Band III DAB channels will be carried out. The display will show "Now tuning". If the radio has been used before the last used station will be selected.
4. During Autotune, the display will show "Scanning" and as each group of stations is detected the station count will be updated. The top line of the display shows a bargraph indicating progress of the Autotune.
5. When the Autotune is completed the first station (in numeric-alpha order 0...9...A...Z) will be selected.
6. If the station list is still empty after the Autotune your radio will display "No signal".
7. If no signals are found it may be necessary to relocate your radio to a position giving better reception.



Roberts

Now tuning...

■■■■■■■■■■  
Scanning... 24

1Xtra  
BBC National

No signal

## Selecting a station - DAB

1. The top line of the display shows the name of the station currently selected.
2. Rotate the **Tuning/Record control** to scroll through the list of available stations. Stop rotating the tuning control when you find the station that you wish to hear.
3. Press and release the **Tuning/Record control** to select the station. The display may show "Now tuning" while your radio finds the new station.
4. Adjust the **Volume control** to the required setting.

Note: If after selecting a station the display shows "Not Available" it may be necessary to relocate your radio to a position giving better reception.

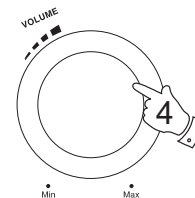
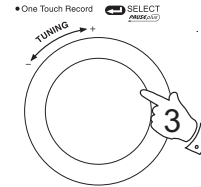
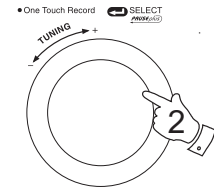

## Presetting stations

There are 5 memory presets on each radio band DAB and FM.

1. Press the **On/Off** button to switch on the radio.
2. Tune to the required station as previously described.
3. Press and hold down the required **Preset** button until the display shows e.g. "Preset 1 saved". The station will be saved under the chosen preset button. Repeat this procedure for the remaining presets.
4. Stations stored in preset memories may be overwritten by following the above procedure.

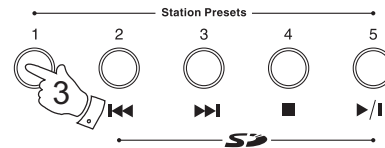

BBC R2  
Preset 1 saved

## Recalling a preset station

1. Press the **On/Off** button to switch on your radio.
2. Select the required waveband by pressing the **Band** button.
3. Momentarily press the required **Preset** button, your radio will tune to the station stored in preset memory.

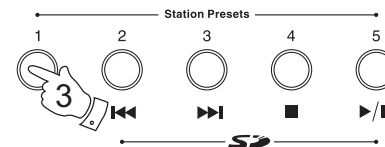

1Xtra  
BBC National

## Finding new stations - DAB

As time passes new stations may become available. To find new stations proceed as follows:-

1. Press and release the **Auto Tune button**, the display will show "Quick scan". Your radio will perform a scan of the UK DAB frequencies. As new stations are found the station counter on the right-hand side of the display will increase and stations will be added to the list.
2. To carry out a full scan of the entire DAB Band III frequencies press and hold down the **Auto Tune button** for more than 2 seconds and then release. The display will show "Full scan". As new stations are found the station counter on the right-hand side of the display will increase and stations will be added to the list.



Autotune  
Quick scan

Now tuning...



Autotune  
Full scan...

## Manual tuning - DAB

Manual tuning allows you to tune directly to the various Band III DAB channels. UK DAB stations are currently located in the range 11B to 12D.

1. Press and hold down the **Advanced Info button**, "Station order" will appear on the display. Then rotate the **Tuning/Record control** until the display shows "Manual tune". Press and release the **Tuning/Record control**.
2. Rotate the **Tuning/Record control** to select the required DAB channel.
3. Press and release the **Tuning/Record control** to select the channel. Any new stations that are found are automatically added to the stored list of stations.
4. Press and release the **Tuning/Record control** to return to normal tuning mode.



♦ ♦ or SELECT  
♦ Station order ♦

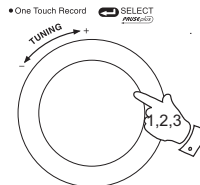

♦ ♦ or SELECT  
♦ Manual tune ♦

11C 220.35 MHz

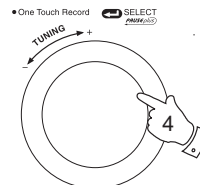

■■■■■□■■■■■  
11C EMAP SV

## Operating your radio - Search tuning FM

1. Fully extend the telescopic aerial for FM reception.
2. Press the **On/Off button** to switch on your radio. The display will show "Roberts" for a few seconds.
3. Press the **Band button** to select the FM band.
4. Press and immediately release the **Auto tune button**, your radio will scan in an upwards direction (low frequency to high frequency) and stop automatically when it finds a station of sufficient strength.
5. After a few seconds the display will update. The display will show the station name.
6. To find other stations, press and release the **Auto tune button** as before.
7. To scan the FM band in a downwards direction (high frequency to low frequency) press and hold down the **Auto tune button** for 0.5 seconds and then release.
8. When the waveband end is reached your radio will recommence tuning from the opposite waveband end.
9. Adjust the **Volume control** to the required setting.
10. To switch off your radio press the **On/Off button**.



Roberts



89.30 MHz FM



Searching... >

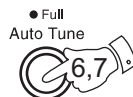

Searching... <

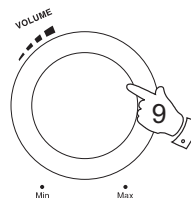

## Manual tuning - FM

1. Press the **On/Off button** to switch on your radio.
2. Press the **Band button** to select the FM band. Fully extend the telescopic aerial for FM reception.
3. Rotate the **Tuning/Record control** to tune to a station. The frequency will change in steps of 50 kHz on FM.
4. When the waveband end is reached the radio will recommence tuning from the opposite waveband end.
5. Set the **Volume control** to the desired settings.
6. To switch off your radio press the **On/Off button**.

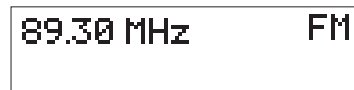
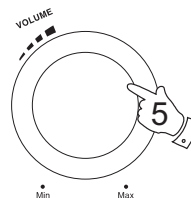
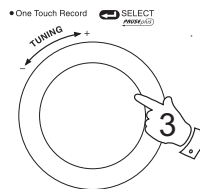

## Additional features DAB and FM

### Secondary services - DAB

1. Certain radio stations have one or more secondary services associated with them. If a station has a secondary service associated with it the display will show ">>" next to the station name on the station list. The secondary service will then appear immediately after the primary service when you rotate the tuning control clockwise.
2. Press and release the **Tuning/Record control** to select the station.

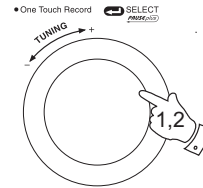



## Display modes - DAB

Your radio has eight display modes:-

1. Press the **Advanced Info** button to cycle through the various modes.

- |                            |   |
|----------------------------|---|
| a. Scrolling text          | Displays scrolling text messages such as artist/track name, phone in number, etc. |
| b. Programme type          | Displays type of station being listened to e.g. Pop, Classic, News, etc.          |
| c. Multiplex name          | Displays name of multiplex to which current station belongs.                      |
| d. Time and date           | Displays current time and date.   |
| e. Channel and frequency   | Displays current channel and frequency.   |
| f. Audio type and bit rate | Displays audio type and bit rate.   |
| g. Signal strength         | Displays signal strength for station being listened to.                           |
| h. Signal error            | Displays error for station being listened to.                                     |



a  
BBC 7  
Just a Minute...

b  
BBC 7  
Culture

c  
BBC 7  
BBC National

d  
BBC 7  
19:17 08-02-2007

e  
BBC 7  
11C 220.35 MHz

f  
BBC 7  
Stereo J 128kbps

g  
BBC 7  
■■■■■□■■■■

h  
BBC 7  
Signal error 0

## Display modes - FM

Your radio has four display modes:-

The Radio Data System (RDS) is a system in which inaudible digital information is transmitted in addition to the normal FM radio programme. RDS offers several useful features. The following are available on your radio:-

1. Press the **Advanced Info** button to cycle through the various modes.



a. Frequency                      Displays the frequency of the station being listened to.



b. Scrolling text                      Displays scrolling text messages such as artist/track name, phone in number, etc.

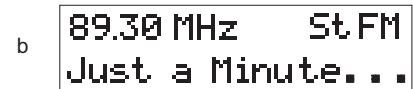

c. Programme Type                      Displays type of station being listened to e.g. Pop, Classic, News, etc.



d. Time and date                      Displays current time and date.

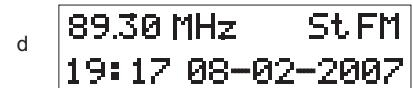

## Using your radio's Pauseplus feature - DAB

How many times has your favourite radio station been interrupted by that phone call from a double glazing firm or someone selling that must have item? Sound familiar? Now with a single press of the **Tuning/Record control** you can put your favourite station on hold while you answer that important call. After the call or other important task is finished simply press the **Tuning/Record control** to return to your favourite station exactly where you left off so that you never miss a single word.

Radio stations can effectively be put on hold between 5 and 20 minutes depending on the station you are listening to.

**Note the PAUSEplus feature only operates on the DAB waveband.**

1. To place your radio in PAUSEplus mode simply press and release the **Tuning/Record control**, the sound from the loudspeaker will be muted. The display will show the "Pause symbol" and the time that you are delayed by.
2. To return to the radio station that you were listening to simply press and release the **Tuning/Record control** and your radio will continue playing from where you left off.
3. To return to real time press in and release the **Stop button**, the display will return to normal radio display.

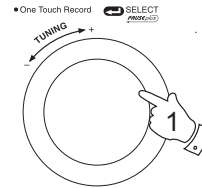

BBC 7 11 @m12s  
Just a Minute...

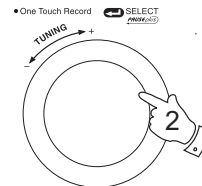

BBC 7 1m12s  
Just a Minute...

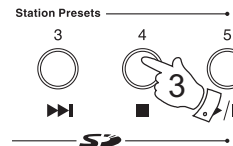

BBC 7  
Just a Minute...

## Pauseplus Rewind and fastforward - DAB

1. Rotate the **Tuning/Record control** or press and hold the **Fastforward** or **Rewind buttons** to scroll to the item you wish to listen.
2. When using your radio's **PAUSEplus** feature the top line of display automatically switches to show the time that you are delayed.

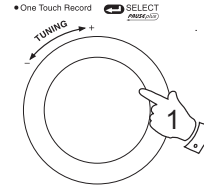

BBC 7 11 0m12s  
Just a Minute...

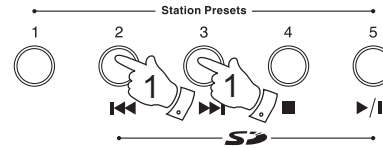

## Dynamic Range Control (DRC) settings

DRC can make quieter sounds easier to hear when your radio is used in a noisy environment.

1. Press the **On/Off button** to switch on your radio.
2. Press and hold in the **Advanced info button** until display shows "Station order."
3. Rotate the **Tuning/Record control** until the display shows "DRC value".
4. Press and release the **Tuning/Record control** to enter adjustment mode.
5. Rotate the **Tuning/Record control** to select required DRC setting (default is 0) .
  - DRC 0 DRC is switched off, Broadcast DRC will be ignored.
  - DRC 1/2 DRC level is set to 1/2 that sent by broadcaster.
  - DRC 1 DRC is set as sent by broadcaster.
6. Press and release the **Tuning/Record control** to confirm the setting. The display will return to radio mode.

• Advanced Info



• One Touch Record SELECT (DRC0)

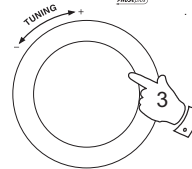

• One Touch Record SELECT (DRC0)

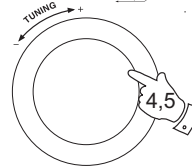

• One Touch Record SELECT (DRC0)

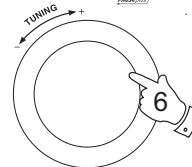

◆ ◆ or SELECT  
◆ Station order ◆

◆ ◆ or SELECT  
◆ DRC value ◆

DRC0  
◆ DRC0 ◆

DRC0  
◆ DRC 1/2 ◆

DRC0  
◆ DRC 1 ◆

## Station order setup - DAB

Your radio has 3 station order settings from which you can choose. The station order settings are, favourite station, alphanumeric and active station.

Note: Your radio default station order is alphanumeric.

1. Press and hold in the **Advanced info button** until "Station order" appears on the display. Press and release the **Tuning control**.
2. Rotate the **Tuning/Record control** to choose between favourite station, alphanumeric and active station.

### Favourite stations

When this setting is switched on, after a period of time the most listened to stations will move to the top of the station list and will be marked with the heart symbol ♥.

### Alphanumeric

Rotate the **Tuning/Record Control** until "Alphanumeric" appears on the display. Your radio will now select stations in alphanumeric order A....Z 0....9.

### Active station

Rotate the **Tuning/Record Control** until "Active station" appears on the display. The display will show only those that a signal can be found.

3. Press and release the **Tuning/Record control** to select the station order setting required.

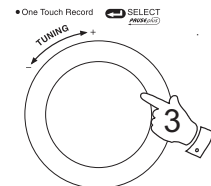
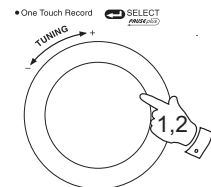

## Prune stations

Some DAB services may stop broadcasting or you may not be able to receive a station. Prune stations will delete the DAB stations from your station list that can no longer be received.

1. Press and hold in the **Advanced info button** until "Station order" appears on the display. Press and release the **Tuning/Record control**.
2. Rotate the **Tuning/Record control** until "Prune stations" appears on the display. Press and release the **Tuning/Record control** to select.

- Advanced Info



◆ ◆ or SELECT  
◆ Station order ◆

- One Touch Record

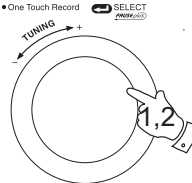

◆ Prune station ◆

## Using an SD memory card with your radio

An SD card can be used in your radio for recording, playing back previously recorded radio programs, or playing back MP2 and MP3 files transferred from a PC.

Depending on the radio station a 128MB SD card will give typically 2- 4 hours of recording time. If you are using a new SD card ensure that it is formatted correctly.

Many different brands and capacities of SD card are available. Your RD55 has been tested with the most popular cards up to 1 GB. However, there are many different card variants available and not all cards can be guaranteed to work in the RD55. The RD55 will not work with cards greater than 2GB capacity or cards which use the High Capacity Secure Digital (HCSD) standard.

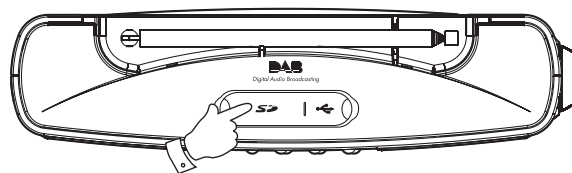

## Inserting and removing a card

To insert an SD card into your radio, lift up the left hand rubber cover on the top of your radio and push the card label side forward and gold contacts first into the SD card slot until it clicks.

To remove the card push the card in slightly and it will pop out allowing removal.

Note: The SD card should not be removed during a recording as damage or corruption of files on the card may occur.

## Recording a Radio program (DAB only)

1. Tune to the DAB station you want to record.
2. Press and hold in the **Tuning/Record control** to start recording. The record icon ● will show in the display.

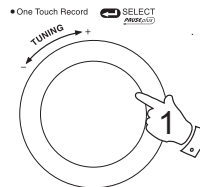



- Press the **Stop button** to stop recording. The recording will be saved on your SD card.
- The recording showing the track details will be added to your playlist. (see page 26)

If your radio is not recording correctly check the following:

- The card is the correct format (reformat as described below).
- The card has enough recording space available. (page 25)
- The card has not become corrupted (possibly by removing the card during recording). Reformat the card if necessary.

## SD Card Format

Formatting your SD card erases any previously recorded files. It also allows an SD card formatted on another device to be re-formatted for use on your radio. The SD card can be formatted in DAB, FM or Playlist mode.

- Insert an SD card into the slot.
- In DAB mode press and hold in the **Advanced info button** and rotate the **Tuning/Record control** until "Memory Card" is shown on display.

If in FM or Playlist mode simply press and hold the **Advanced info button** and "Memory Card" will show on display.

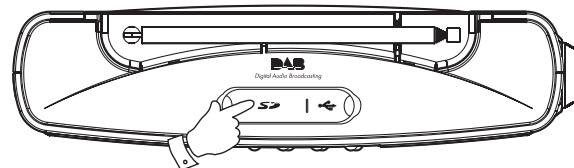

- Advanced Info



- One Touch Record

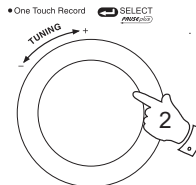

- Press and release the **Tuning/Record control**.
  - Rotate the **Tuning/Record control** until "Memory Card Format" appears on the display.
  - Press and release the **Tuning/Record control** "Continue format No" will appear on the display. To select yes rotate the **Tuning/Record control** until "Yes" appears on the display.
  - Press and release the **Tuning/Record control** and "Formatting please wait" will appear on the display. Your sd card will be formatted and the display will show "formatted". The radio will return to the previous screen.
- If you do not wish to format your SD card Rotate the **Tuning/Select control** until "No" appears on the display.

### To view space on SD card

- In DAB mode press and hold in the **Advanced info button** and rotate the **Tuning/Record control** until "Memory Card" is shown on display.  
If in FM or Playlist mode simply press and hold the **Advanced info button** and "Memory Card" will show on display.
- Press and release the **Tuning/Record control**.
- Rotate the **Tuning/Record control** until "Remaining free space" appears on the display.

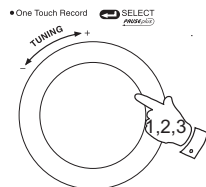
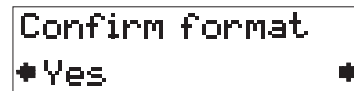
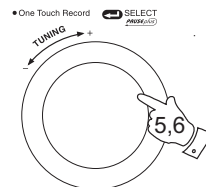
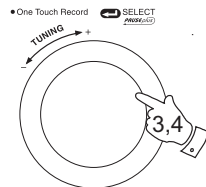

## File playback

The playlist mode displays the files on the current memory card. The display will show the current file details.

1. Ensure your SD card is inserted correctly.
2. Press the **Band** button until the Play list mode is selected. "Finding tracks" will be displayed then the current recording or track on your SD card will show on the display.
3. You can scroll through the list using the **Tuning/Record control** or the **Fastforward/Rewind buttons**.

## To play files

1. Press the **Play/Pause** button.
2. Your playlist recordings will be played in list order from the first selected file.
3. To pause playback press the **Play/pause** button. To resume playback press the **Play/pause** button again.

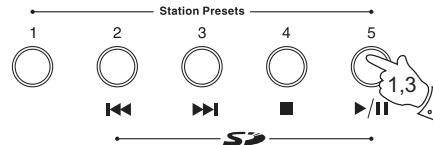
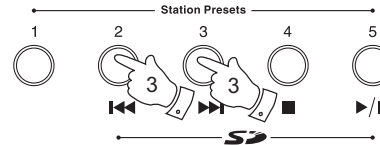
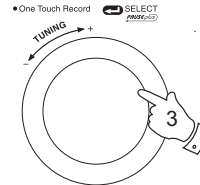

## Fast forward files

1. Press the **Fast Forward button** to skip to the next track until all files have been played.
2. Whilst a track is playing rotate **Tuning/Record control** the until the desired part of the track is reached.

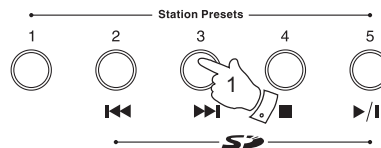

## Rewind files

1. Press the **Rewind button** to skip back a track until all files have been played.
2. Whilst a track is playing rotate **Tuning/Record control** until the desired part of the track is reached.

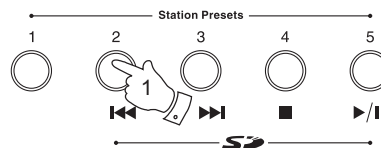

## Stop playing files

1. Press the **Stop button** and the track will stop playing and return to the playlist.

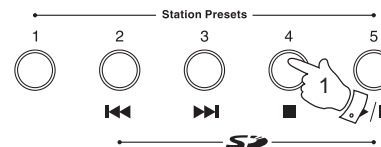

## Delete files

1. In DAB mode press and hold in the **Advanced info button** and rotate the **Tuning/Record control** until "Memory Card" is shown on display.

If in FM or Playlist mode simply press and hold the **Advanced info button** and "Memory Card" will show on the display.

2. Press and release the **Tuning/Record control**.
3. Rotate the **Tuning/Record control** until "Delete track" appears on the display.
4. Press and release the **Tuning/Record control** the display "will show finding tracks" then will return to the list of tracks.
5. Either rotate the **Tuning/Record control** or **press the Fastforward or Rewind buttons** to select a track for deletion.
6. Press and release the **Tuning/Record control** the display will show "Confirm delete".
7. Rotate the **Tuning/Record control** to select "Yes" on the display.
8. Press and release the **Tuning/Record control** and your file will be deleted from your track list. The radio will return to your track list.

- Advanced Info



- One Touch Record SELECT

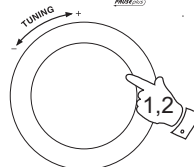

- One Touch Record SELECT

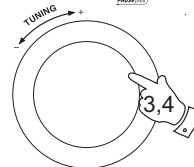

- One Touch Record SELECT

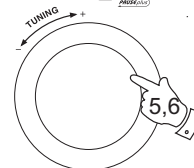

- One Touch Record SELECT

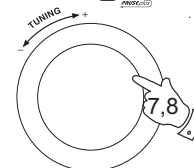

## USB connection

Your radio has a USB connection to connect your PC. The usb can be used to copy files to and from your SD card and also for any software updates available.

When the USB connection is used to link your radio to your PC the SD card should appear as a removable disk drive. MP2 and MP3 files are held in a folder called "RADIO".

If your PC already has an SD card reader, you will find that file transfer is faster when using this than when using the USB connection to your radio.

Your radio uses the FAT 16 format for storing files on the SD card.

1. Lift up the right hand side rubber cover on the top of your radio and insert the usb cable into the slot.

2. In DAB mode press and hold in the **Advanced info button** and rotate the **Tuning/Record control** until "Memory Card" is shown on display.

If in FM or Playlist mode simply press and hold the **Advanced info button** and "Memory Card" will show on display.

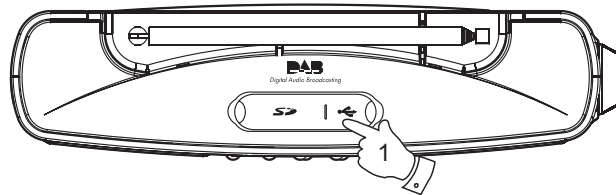

• Advanced Info



• One Touch Record 

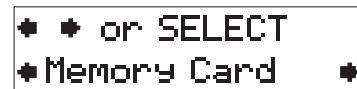
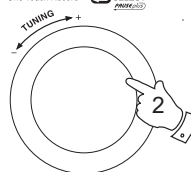

3. Press and release the **Tuning/Record control**.
4. Rotate the **Tuning/Record control** until "USB File Copy" appears on the display.
5. Press and release the **Tuning/Record control** to allow files to be copied between your PC and your SD card.
6. Use windows explorer (or equivalent software) to copy the files as needed. Remember, the RD55 radio records files into and plays files from the "RADIO" folder on the SD card.
7. When you have finished copying files press and release the **Tuning/Record control**. The radio will return to the playlist mode.

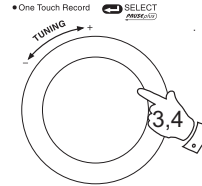

Memory Card  
 ◆ USB File Copy ◆

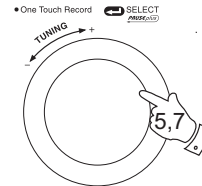

USB File Copy  
 Select to Stop

## FM Stereo/Mono

1. If a station being received is weak some hiss may be audible. To reduce the hiss press and release in the **Tuning/Record control** until the display shows "Audio mode : Mono" your radio will switch to mono mode.
2. To return to stereo mode press and release the **Tuning/Record control** until the display shows "Audio mode : Auto", your radio will switch to stereo mode.

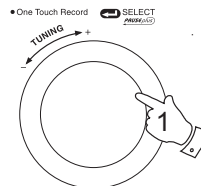

89.30 MHz FM  
Mono

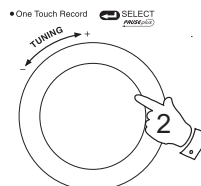

89.30 MHz FM  
Auto

## Software version

The software display cannot be altered and is just for your reference.

1. To view which software version your radio has press and hold in the **Advanced info button** until "Station order" appears on the display.
2. Rotate the **Tuning/Record control** until the software version shows on the display.



◆ U.135.5.2  
◆ Sw Version ◆

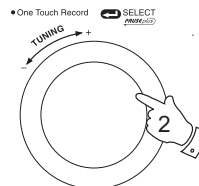



## Signal strength display - DAB

1. Press and release the **Advanced info button** until the lower line of the display shows the signal strength.
2. Position your radio and carefully angle the telescopic aerial for best reception using the signal strength display as a guide. Move your radio around and position to give maximum number of black rectangles on signal strength display. The clear unfilled rectangle indicates minimum signal level required for satisfactory reception.



## System reset

If your radio fails to operate correctly, or some digits on the display are missing or incomplete carry out the following procedure.

1. Switch on your radio.
2. Press and hold in the **Advanced info** button until "Station order" appears on the display.
3. Rotate the **Tuning/Record control** until the display shows "Factory reset".
4. Press in and release the **Tuning/Record control**, the display will show "Press SELECT to confirm reset . . .".
5. Press the **Tuning/Record control** to confirm. A full reset will be performed and all presets and station lists will be erased. A quick scan of UK DAB band III frequencies will be carried out.

In case of malfunction due to electrostatic discharge, reset the product (reconnection of power source may be required) to resume normal operation.

If a problem persists our technical staff would be pleased to offer any assistance on operating the radio. Our technical helpline number is 020 8758 0338.

• Advanced Info



• One Touch Record  SELECT PRESET

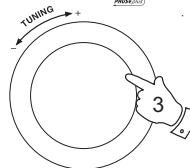

• One Touch Record  SELECT PRESET

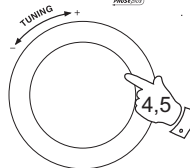

◆ ◆ or SELECT  
◆ Station order ◆

◆ ◆ or SELECT  
◆ Factory reset ◆

Press SELECT to  
confirm reset...

■■■■■■■■■■  
Scanning... 24

## Auxiliary in socket

1. Connect a stereo or mono audio source (ie CD Walkman, iPod, MP3 player) to the **Auxiliary in socket**.
2. Press the **Band** button to select AUX band. "AUX IN" will show on the display.
3. Adjust the **Volume control** for comfortable listening.

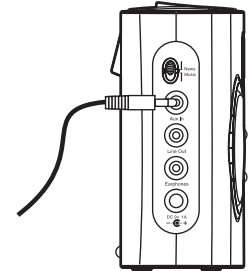

## Line out socket

A 3.5mm **Line out socket** located on the left hand end of your radio is provided for connecting the audio signal to an external amplifier. Inserting a line out audio cable will not mute the internal loudspeaker. Set the volume control to the minimum if desired.

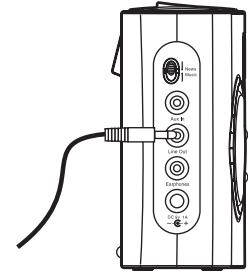

## Headphone socket

A 3.5mm **Headphone socket** located on the left hand end of your radio is provided for use with either headphones or an earpiece. Inserting a plug automatically mutes the internal loudspeaker.

**IMPORTANT:** Excessive sound pressure from earphones and headphones can cause hearing loss.

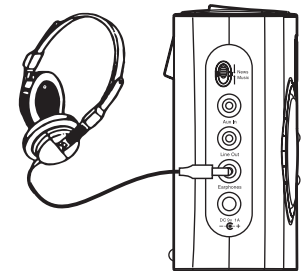

## News/Music sound switch

For all normal listening it is recommended to use the News/Music switch in the music position.

The alternative News position is intended to emphasise speech when there is significant background noise or music in the program content. It is not recommended for normal listening.

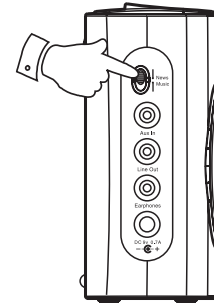

## Display backlight

1. When your radio is powered by the AC adaptor the display backlight will be switched on when the radio is in use.
2. When using on batteries, the display backlight will be switched on for approx. 12 seconds when any button is pressed.

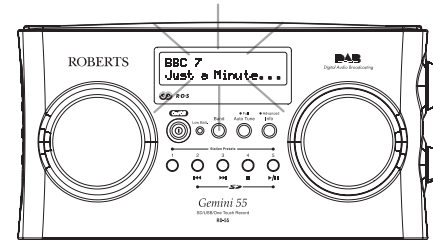

## General

Do not allow this radio to be exposed to water, steam or sand. Do not leave your radio where excessive heat could cause damage such as in a parked car where the heat from the sun can build up even though the outside temperature may not seem too high.



The name plate is located on the back of your radio.

- Your radio should not be exposed to dripping or splashing and that no objects filled with liquids, such as vases, shall be placed on the radio.
- It is recommended to operate the product such that there is a minimum distance (10cm recommended) to adjacent objects in order to ensure good ventilation.
- The ventilation of the product should not be restricted by covering it or its ventilation openings with items such as newspapers, tablecloths, curtains etc.
- No naked flame sources such as lighted candles should be placed on the product.
- It is recommended to avoid using or storing the product at extremes of temperature. Avoid leaving the unit in cars, on window sills, in direct sunlight etc.

## Specifications

### Power Requirements

AC adaptor	AC 230 volts, 50Hz $\sim$ only
Batteries	6 x LR14 (C size)

### Battery Life

Approx. 20 hours, listening for 4 hours a day at normal volume using alkaline cells.

### Frequency Coverage

DAB	174.928 - 239.200MHz
FM	87.50 - 108 MHz

## Circuit features

Loudspeaker	2 x 89mm 8ohms
Output Power	2 x 1 Watt
Headphone socket	3.5mm dia
Aux in socket	3.5mm dia
Line out	3.5mm dia

### Aerial System

DAB and FM	Telescopic aerial
------------	-------------------

*The Company reserves the right to amend the specification without notice*

## Guarantee

This instrument is guaranteed for twelve months from the date of delivery to the original owner against failure due to faulty workmanship or component breakdown, subject to the procedure stated below. Should any component or part fail during this guarantee period it will be repaired or replaced free of charge.

The guarantee does not cover:

1. Damage resulting from incorrect use.
2. Consequential damage.
3. Receivers with removed or defaced serial numbers.

N.B. Damaged or broken telescopic aerials will not be replaced under guarantee.

Procedure:

Any claim under this guarantee should be made through the dealer from whom the instrument was purchased. It is likely that your Roberts' dealer will be able to attend to any defect quickly and efficiently but should it be necessary the dealer will return the instrument to the Company's service department for attention. In the event that it is not possible to return the instrument to the Roberts' dealer from whom it was purchased, please contact Roberts Radio Technical Services at the address shown below.

*These statements do not affect the statutory rights of a consumer.*



Issue 1

## ROBERTS RADIO TECHNICAL SERVICES

97-99 Worton Road

Isleworth Middlesex

TW7 6EG

Technical Helpline :- 020 8758 0338 (Mon-Fri during office hours)

Website: <http://www.robertsradio.co.uk>

