

# ROBERTS

Sound for Generations

## RD-45

FM RDS/DAB digital radio

*Gemini 45*



Please read this manual before use

**DAB**  
Digital Audio Broadcasting

## Contents

<i>Controls</i> .....	2-3	<i>System reset</i> .....	17
<i>Battery operation</i> .....	4	<i>Headphone socket</i> .....	18
<i>Using the AC adaptor</i> .....	5	<i>Line out socket</i> .....	18
<i>Operating your radio - DAB</i> .....	6	<i>Display backlight</i> .....	18
<i>Selecting a station - DAB</i> .....	7	<i>General</i> .....	19
<i>Secondary services - DAB</i> .....	7	<i>Specifications</i> .....	20
<i>Display modes - DAB</i> .....	8	<i>Circuit features</i> .....	20
<i>Finding new stations - DAB</i> .....	9	<i>Guarantee</i> .....	21
<i>Signal strength display - DAB</i> .....	9	<i>Notes</i> .....	22
<i>Manual tuning - DAB</i> .....	10		
<i>Dynamic range control - DAB</i> .....	11		
<i>Operating your radio - FM</i> .....	12		
<i>Manual tuning - FM</i> .....	13		
<i>Display modes - FM</i> .....	14		
<i>FM Stereo/Mono function</i> .....	14		
<i>Software version</i> .....	15		
<i>Presetting stations</i> .....	15		
<i>Recalling a preset</i> .....	16		
<i>Favourite button</i> .....	16		

## Controls

(Front)

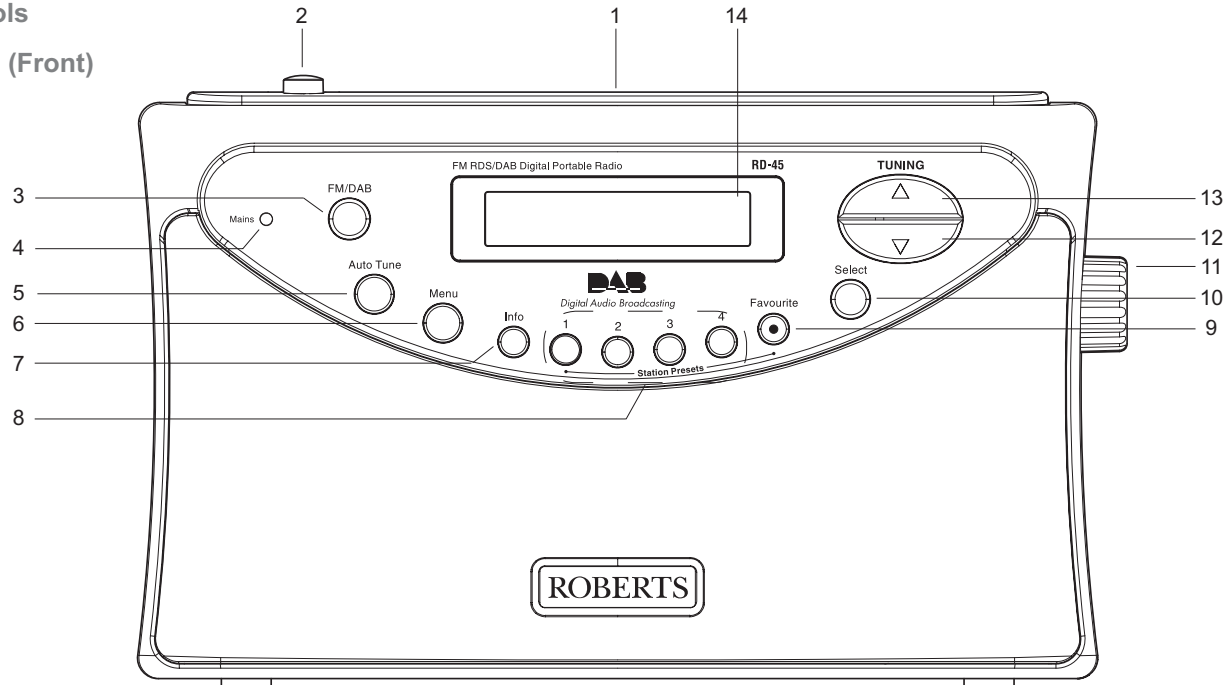

1. Telescopic aerial

2. On/Off button

3. FM/DAB button

4. Mains indicator

5. Auto Tune button

6. Menu button

7. Info button

8. Preset buttons 1-4

9. Favourite button

10. Select button

11. Volume control

12. Tuning Down button

13. Tuning Up button

14. LCD display

Controls  
(Back)

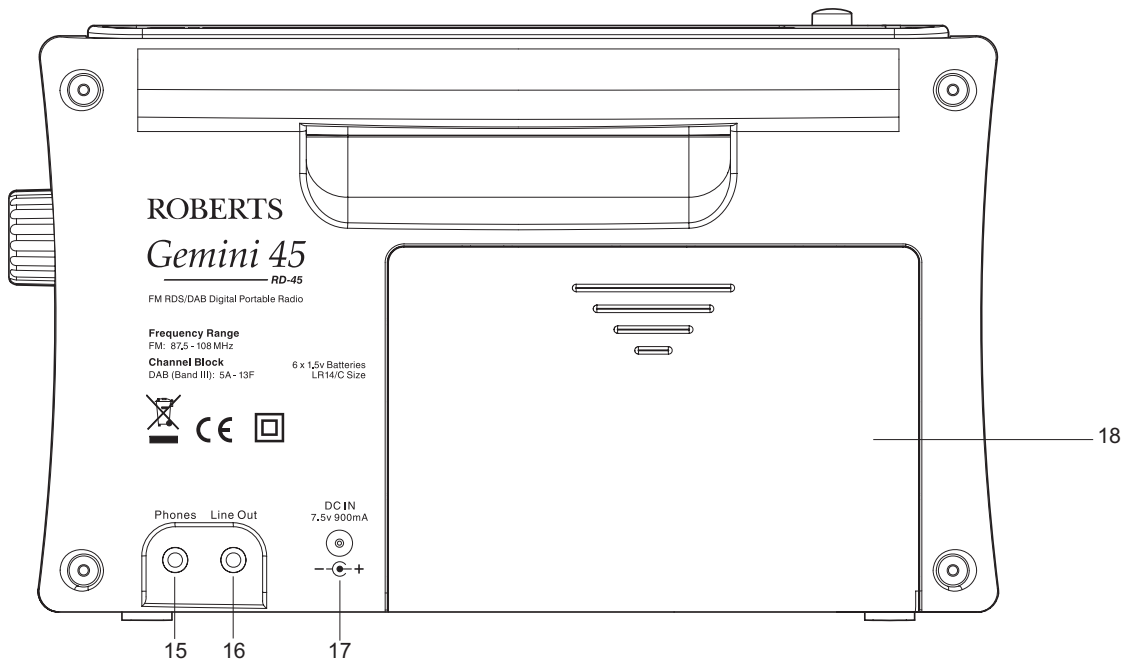

- 15. Headphone socket
- 16. Line out socket

- 17. DC jack socket
- 18. Battery compartment

## Battery operation

1. Remove the battery cover on the back of the unit by sliding the cover in the direction of the arrow.
2. Insert six LR14 (C size) batteries into the spaces in the compartment. Take care to ensure all batteries are inserted with the correct polarity as shown inside the battery compartment. Replace the battery cover.
3. Reduced power, distortion and a 'stuttering' sound are all signs that the batteries may need replacing.
4. If the radio is not to be used for any extended period of time it is recommended that the batteries are removed from the radio.

*We would recommend for economy that the RD-45 is used via the AC adaptor whenever possible with battery operation for occasional or stand-by use only.*

**IMPORTANT:** The batteries should not be exposed to excessive heat such as sunshine, fire or the like. After use, disposable batteries should if possible be taken to a suitable recycling centre. On no account should batteries be disposed of by incineration.

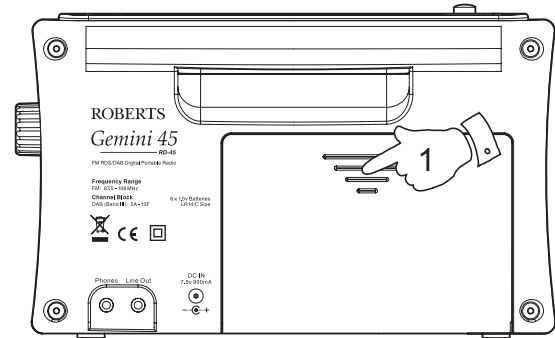

## Using the AC adaptor

The AC adaptor for use with the RD45 should provide 7.5 volts DC output at 900mA centre pin positive.

1. Insert the adaptor plug into the DC in socket on the rear of your radio.
2. Plug the adaptor into a standard 13A mains socket outlet. Whenever the adaptor is used the batteries are automatically disconnected.

*The AC adaptor should be disconnected from the mains supply and the radio when not in use.*

- **IMPORTANT:** The mains adaptor is used as the means of connecting the radio to the mains supply. The mains socket used for the radio must remain accessible during normal use. In order to disconnect the radio from the mains completely, the mains adaptor should be removed from the mains socket outlet completely.

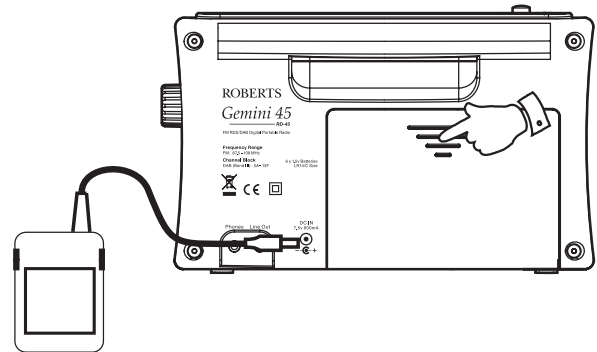

## Operating your radio - DAB

1. Carefully extend the telescopic aerial.
2. Press the **On/Off button** to switch on your radio. The **mains indicator** will light and the display will show "Roberts digital radio" for a few seconds.
3. If this is the first time the radio is used a quick scan of UK Band III DAB channels will be carried out. The display will show "Now tuning". If the radio has been used before the last used station will be selected.
4. During Autotune, the display will show "Scanning" and as each group of stations is detected the station count will be updated. The bottom line of the display shows a bargraph indicating progress of the Autotune.
5. When the Autotune is completed the first station (in numeric-alpha order 0...9...A...Z) will be selected. The first station in the list of stations found will be played. The display will show the station name in the first line of the display and other information in the second line.
6. If the station list is still empty after the Autotune your radio will display "No Signal".
7. If no stations are found, "Station not available" will be displayed and it may be necessary to relocate your radio to a position giving better reception. You should then carry out an autoscan to find stations as described on page 9.

On/Off



Roberts  
digital radio

Scanning... 24  
■■■■■■■■■■

Now tuning...

No Signal

Station not  
available

## Selecting a station - DAB

1. The top line of the display shows the name of the station currently selected.
2. Press the **Tuning Up or Down buttons** to scroll through the list of available stations.
3. Press and release the **Select button** to select the station. The display may show "Now tuning" while your radio finds the new station.
4. Rotate the **Volume control** to the required setting.

Note: If after selecting a station the display shows "No station available" it may be necessary to relocate your radio to a position giving better reception.

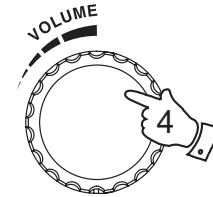
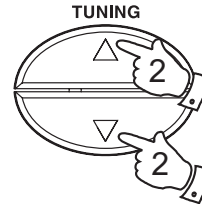

---

## Secondary services - DAB

1. Certain radio stations have one or more secondary services associated with them. If a station has a secondary service associated with it the display will show ">>" next to the station name on the station list. The secondary service will then appear immediately after the primary service as you press the Tuning Up button.
2. Press the **Select button** to select the station.





## Display modes - DAB

Your radio has seven display modes:-

1. Press the **Info button** to cycle through the various modes.
  - a. Scrolling text Displays scrolling text messages such as artist/track name, phone in number, etc.
  - b. Programme type Displays type of station being listened to e.g. Pop, Classic, News, etc.
  - c. Multiplex Name Displays name of multiplex to which current station belongs.
  - d. Time and date Displays current time and date.
  - e. Channel & frequency Displays channel number and frequency.
  - f. Bit rate/audio type Displays the digital bit rate and audio type.
  - g. Signal strength Displays signal strength for station being listened to.



a  
BBC 7  
Just a Minute...

b  
BBC 7  
Culture

c  
BBC 7  
BBC National

d  
BBC 7  
19:17 08-06-2006

e  
BBC 7  
11C 220.35 MHz

f  
BBC 7  
128kbps Stereo

g  
BBC 7  
■■■■■□■■■■

## Finding new stations - DAB

As time passes new stations may become available. To find new stations proceed as follows:-

1. Press and release the **Auto Tune button**, your radio will perform a scan of the UK DAB frequencies. As new stations are found the station counter on the right-hand side of the display will increase and stations will be added to the list.
2. To carry out a full scan of the entire DAB Band III frequencies press and hold down the **Auto Tune button** for more than 2 seconds and then release. The station counter on the right-hand side of the display will increase and stations will be added to the list.

Auto Tune



Auto Tune



---

## Signal strength display - DAB

1. Press and release the **Info button** until the display shows signal strength.
2. Position your radio and carefully angle the telescopic aerial for best reception using the signal strength display as a guide. Move your radio around and position so as to give maximum number of black rectangles on signal strength display. The clear unfilled rectangle indicates minimum signal level required for satisfactory reception.
3. Press the **Info button** to exit the signal strength display.

Info



## Manual Tuning - DAB

Manual tuning allows you to tune directly to the various DAB Band III channels. UK DAB stations located in the range 11B to 12D.

1. Press and release the **Menu button** the display will show "Manual tune".
2. Press and release the **Select button**.
3. Press either the **Tuning Up or Down buttons** to select the required DAB channel.
4. Press and release the **Select button** to select the required DAB channel. The open bar in the middle shows you the minimum signal strength needed for good DAB reception. The signal strength bars will go up and down showing the changing signal strength as you adjust the telescopic aerial on your radio.
5. When a DAB signal is found, the display will show the name of the DAB multiplex. Any new radio stations found will be added to the list stored in the radio.
6. Press and release the **Select button** to return to normal tuning.

Menu



Select



TUNING

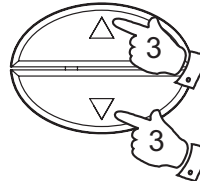

Select



## Dynamic Range Control (DRC) settings - DAB

DRC can make quieter sounds easier to hear when your radio is used in a noisy environment.

1. Press the **On/Off button** to switch on your radio.
2. Press and release the **Menu button** the display will show "Manual tune."
3. Press the **Tuning Up or Down buttons** until the display shows "DRC value".
4. Press and release the **Select button** to enter adjustment mode.
5. Press the **Tuning Up/Down buttons** to select required DRC setting (default is 0).
  - DRC 0 DRC is switched off, Broadcast DRC will be ignored.
  - DRC 1/2 DRC level is set to 1/2 that sent by broadcaster.
  - DRC 1 DRC is set as sent by broadcaster.
6. Press and release the **Select button** to confirm the setting. The display will return to normal tuning mode.

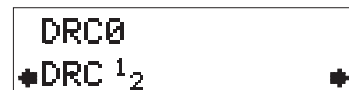
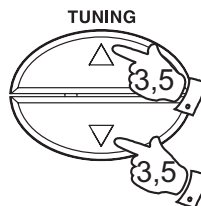
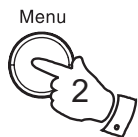

## Operating your radio - FM

1. Carefully extend the telescopic aerial.
2. Press the **On/Off button** to switch on your radio. The display will show "Roberts digital radio" for a few seconds.
3. Press the **FM/DAB button** to select the FM band.
4. Press the **Tuning Up button** and then press the **Auto Tune button** your radio will scan in an upwards direction (low frequency to high frequency) and stop automatically when it finds a station of sufficient strength.
5. After a few seconds the display will update and show station name.
6. Press the **Tuning Down button** and then press the **Auto Tune button** to scan the FM band in a downwards direction (high frequency to low frequency).
7. When the waveband end is reached your radio will recommence tuning from the opposite waveband end.
8. Rotate the **Volume control** to the required setting.
9. To switch off your radio press the **On/Off button**.



FM/DAB

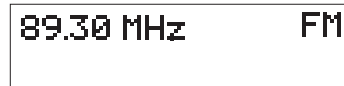
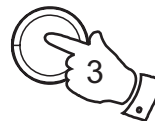

TUNING

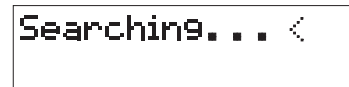
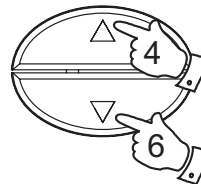

Auto Tune



## Manual tuning - FM

1. Press the **On/Off button** to switch on your radio.
2. Press the **FM/DAB button** to select the FM band. Fully extend the **Telescopic aerial**.
3. Press either the **Tuning Up or Down buttons** to tune to a station. The frequency will change in steps of 50kHz.
4. When the waveband end is reached the radio will recommence tuning from the opposite waveband end.
5. Rotate the **Volume control** to the required setting.
6. To switch off your radio press the **On/Off button**.

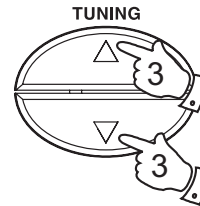
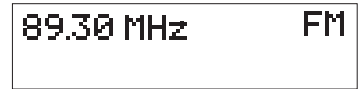
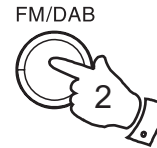

## Display modes - FM

On FM the bottom line of the display can be set to any of the following modes:-

1. Press the **Info button** to cycle through the various modes.
  - a. Scrolling text Displays scrolling text messages such as artist/track name, phone in number etc.
  - b. Program Type Displays type of station being listened to e.g. Pop, Classic, News, etc.
  - c. Time and date Displays current time and date.
  - d. Frequency & audio mode Displays frequency of the station being listened to and displays the audio mode, Auto (stereo) or mono



a	BBC R2 FM The latest news
b	BBC R2 FM Pop Music
c	BBC R2 FM 12:02 16-06-2003
d	BBC R2 FM 88.10MHz Stereo

## FM Stereo/Mono

1. If a station being received is weak, some hiss may be audible. To reduce the hiss, press and release the **Select button** until the display shows "Mono", your radio will switch to mono mode.
2. To return to stereo mode, press and release the **Select button** until the display shows "Auto", your radio will switch to stereo mode.



BBC R2 FM Mono
BBC R2 FM Auto

## Software version

The software display cannot be altered and is just for your reference.

1. In FM mode, press the **Menu button**, the software version will appear on the display.
2. In DAB mode, press the **Menu button** and then press the **Tuning Up or Down buttons** until the software version appears on the display.

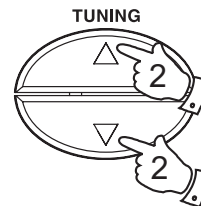
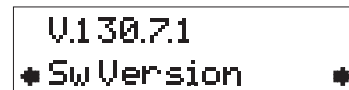
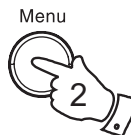
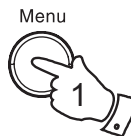

## Presetting stations

There are 4 memory presets for each of the two wavebands.

1. Press the **On/Off button** to switch on your radio.
2. Tune to the required station as previously described.
3. Press and hold the required **Preset button** until the display shows e.g. Preset 1 saved. The station will be stored under the chosen preset button. Repeat this procedure for the remaining presets.
4. Stations stored in the memories may be overwritten by following the above procedure.

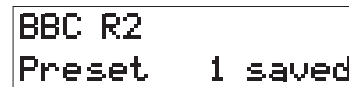
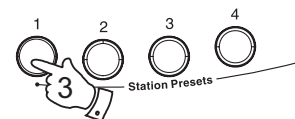



## Recalling a preset

1. Press the **On/Off button** to switch on your radio.
2. Select the required waveband.
3. Momentarily press the required **Preset button**, your radio will tune to the station stored in preset memory.

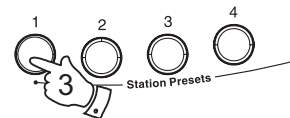

BBC 7 DAB  
Just a Minute...

## Favourite button

Your radio is fitted with a button which when pressed will automatically select the required waveband and tune to your favourite station. This will allow you to store a total of one station from either the FM or DAB waveband.

1. To set up your favourite station, tune into the required station.
2. Press and hold down the **Favourite button** (10 sec) until the display shows "Favourite stored".

Favourite



BBC 7 DAB  
Favourite stored

## Recalling your favourite station

1. Press the **On/Off button** to switch on the radio.
2. Momentarily press the **Favourite button**, your radio will tune to the station stored in favourite memory.



BBC 7 DAB  
Just a Minute...

Favourite



## System reset

If your radio fails to operate correctly, or some digits on the display are missing or incomplete carry out the following procedure.

1. Press and hold down the **Menu button** for 2 seconds the display shows "Press SELECT to confirm reset".
2. Press in and release the **Select button** to select System reset.
3. A full reset will be performed. All presets and station lists will be erased.
4. After a system reset a scan of the DAB band will be performed.

In case of malfunction due to electrostatic discharge, reset the product (reconnection of power source may be required) to resume normal operation.

**If a problem persists our technical staff would be pleased to offer any assistance on operating the radio. Our technical helpline number is 020 8758 0338.**

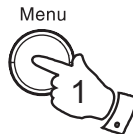

Press SELECT to  
confirm reset...

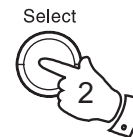

Scanning... 24  
■■■■■■■■■■

## Headphone socket

A 3.5mm **Headphone Socket** located on the rear of your radio is provided for use with either headphones or an earpiece. Inserting a plug automatically mutes the internal loudspeaker.

**IMPORTANT:** Excessive sound pressure from earphones and headphones can cause hearing loss.

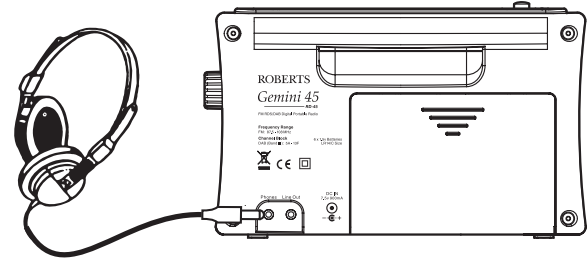

## (Line out) socket

A 3.5mm **Line out socket** located on the rear of your radio is provided for connecting the audio signal to an external amplifier. Inserting a plug into the line output socket will not mute the internal loudspeaker. Set the volume control to adjust the speaker volume level as required.

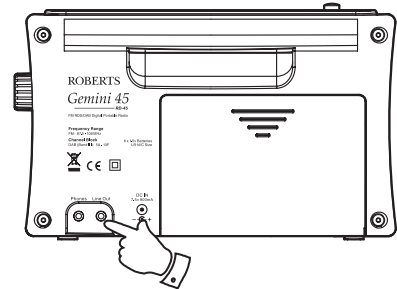

---

## Display backlight

1. When using on batteries, the display backlight will be switched on for approximately 12 seconds when any button is pressed.
2. When your radio is powered by AC mains the display backlight will always be switched on.

*If you need any further advice, please call our Technical Helpline on :-  
020 8758 0338 (Mon-Fri)*

## General

Do not allow this radio to be exposed to water, steam or sand. Do not leave your radio where excessive heat could cause damage such as in a parked car where the heat from the sun can build up even though the outside temperature may not seem too high. It is recommended that the DAB band be used wherever possible as better results in terms of quality and freedom from interference will usually be obtained than on the FM band.

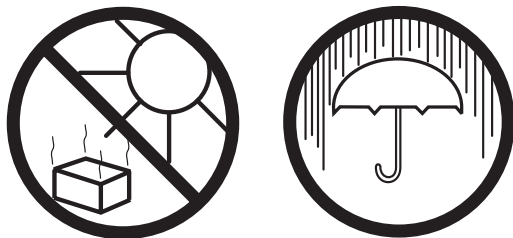

The name plate is located on the back of your radio.

- Your radio should not be exposed to dripping or splashing and that no objects filled with liquids, such as vases, shall be placed on the radio.
- It is recommended to operate the product such that there is a minimum distance (10cm recommended) to adjacent objects in order to ensure good ventilation.
- The ventilation of the product should not be restricted by covering it or its ventilation openings with items such as newspapers, tablecloths, curtains etc.
- No naked flame sources such as lighted candles should be placed on the product.
- It is recommended to avoid using or storing the product at extremes of temperature. Avoid leaving the unit in cars, on window sills, in direct sunlight etc.

## Specifications

### Power Requirements

Mains	AC 230 volts, 50Hz  only (adaptor)
Batteries	6 x LR14 (C size)

### Battery Life

Approx. 30 hours of listening for 4 hours a day at normal volume using alkaline cells.

### Frequency Coverage

FM	87.5-108MHz
DAB	174.928 - 239.200MHz

## Circuit Features

Loudspeaker	76mm	
Headphone socket	3.5mm dia	
Output Power	1W into 8 ohms	
Line out socket	3.5mm dia	
Aerial System	FM	Telescopic aerial
	DAB	Telescopic aerial

*The Company reserves the right to amend the specification without notice*

## Guarantee

This instrument is guaranteed for twelve months from the date of delivery to the original owner against failure due to faulty workmanship or component breakdown, subject to the procedure stated below. Should any component or part fail during this guarantee period it will be repaired or replaced free of charge.

The guarantee does not cover:

1. Damage resulting from incorrect use.
2. Consequential damage.
3. Receivers with removed or defaced serial numbers.

N.B. Damaged or broken telescopic aerials will not be replaced under guarantee.

Procedure:

Any claim under this guarantee should be made through the dealer from whom the instrument was purchased. It is likely that your Roberts' dealer will be able to attend to any defect quickly and efficiently but should it be necessary the dealer will return the instrument to the Company's service department for attention. In the event that it is not possible to return the instrument to the Roberts' dealer from whom it was purchased, please contact Roberts Radio Technical Services at the address shown on the rear of this manual.

*These statements do not affect the statutory rights of a consumer.*

## Notes

*If you need any further advice, please call our Technical Helpline on :-  
020 8758 0338 (Mon-Fri)*



Issue 1

## **ROBERTS RADIO TECHNICAL SERVICES**

97-99 Worton Road  
Isleworth Middlesex

TW7 6EG

Technical Helpline :- 020 8758 0338 (*Mon-Fri during office hours*)

*Website: <http://www.robertsradio.co.uk>*

