

ROBERTS

Sound for Generations

RD-25

MW/FM RDS/DAB Digital Portable Radio

Gemini 25



DAB

Digital Audio Broadcasting

Please read this manual before use

Contents

Controls	2-4	Software version.....	13
Battery operation	5	Operating your radio - search tuning FM and MW	14
Mains operation	5	Manual tuning - FM and MW	15
Operating your radio - DAB	6	Display modes FM.....	16
Selecting a station - DAB	7	Presetting stations - FM and MW	17
Secondary services - DAB	7	Recalling a preset station - FM and MW	17
Display modes - DAB	8	FM stereo/mono function.....	18
Finding new stations - DAB	9	Sleep function.....	19
Manual tuning - DAB	9	System reset	20
Signal strength display - DAB	10	Display backlight	20
Presetting stations - DAB	10	Auxiliary in socket.....	21
Recalling a preset station - DAB	11	Line out socket	21
Station order setup - DAB	11-12	Headphone socket	21
Favourite station order	12	Spatial sound switch.....	22
Alphanumeric station order	12	General.....	22
Active station order	12	Specifications	22
Prune stations	12	Circuit features	22
Dynamic range control (DRC)	13	Guarantee	back cover

Controls

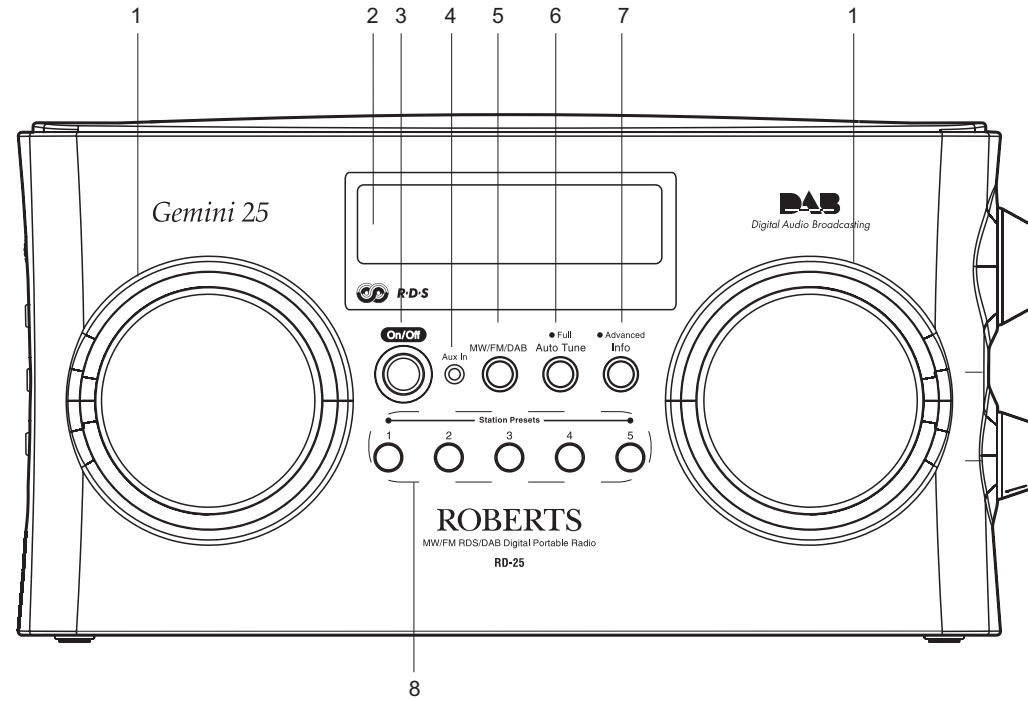

- 1. Speakers
- 2. LCD display
- 3. On/Off button

- 4. Auxiliary input indicator
- 5. MW/FM/DAB waveband button
- 6. Auto tune button

- 7. Advanced information button
- 8. Station preset buttons

If you need any further advice, please call our Technical Helpline on :-
020 8758 0338 (Mon-Fri)

Controls (rear)

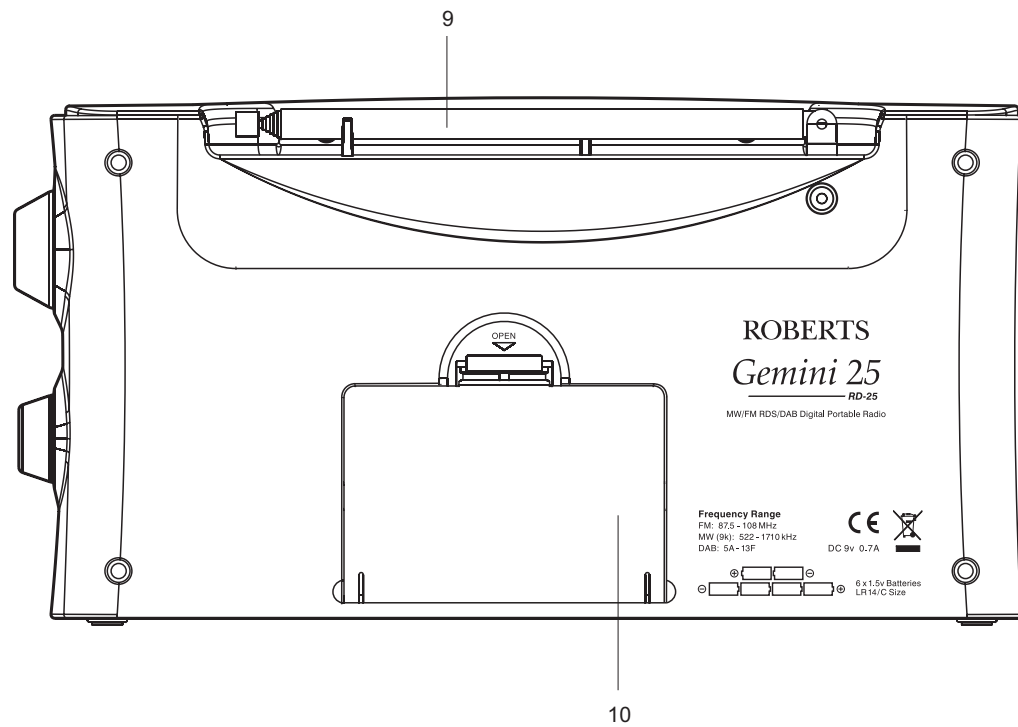

- 9. Telescopic aerial
- 10. Battery compartment

Controls

Left hand side

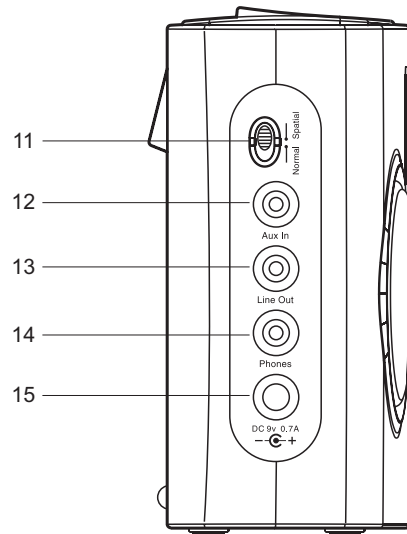

- 11. Spatial sound switch
- 12. Auxiliary in socket
- 13. Line out socket

Right hand side

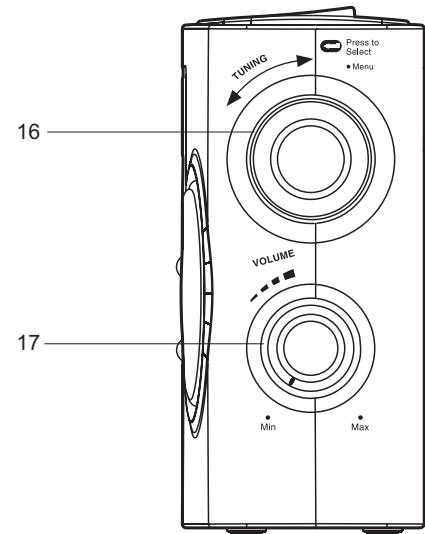

- 14. Earphone socket
- 15. DC socket
- 16. Rotary tuning control

- 17. Volume control

If you need any further advice, please call our Technical Helpline on :-
020 8758 0338 (Mon-Fri)

Battery operation

1. Remove the **Battery cover** on the rear of the unit by pushing the catch downwards. Open the battery door.
2. Insert six LR14 (C size) batteries into the spaces in the compartment. Take care to ensure all batteries are inserted with the correct polarity as shown on the rear of your radio. Close the battery door.
3. Reduced power, distortion and a 'stuttering' sound are all signs that the batteries may need replacing.
4. If the radio is not to be used for any extended period of time it is recommended that the batteries are removed from the radio.

We would recommend for economy that the RD-25 is used via the mains adaptor whenever possible with battery operation for occasional or stand-by use only.

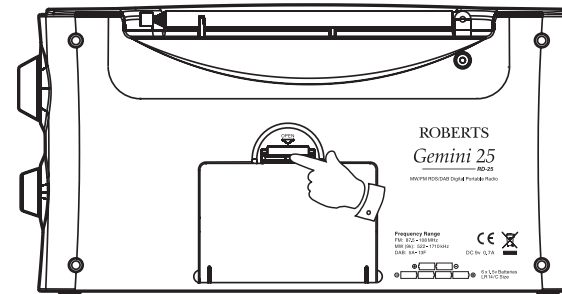

Using the AC adaptor

Your radio is supplied with a Mains Adaptor.

1. Place your radio on a flat surface.
2. Insert the adaptor plug into the DC socket located on the left hand end of your radio.
3. Plug the adaptor into a standard 13 amp mains socket outlet. Whenever the adaptor is used, the batteries are automatically disconnected.

The AC adaptor should be disconnected from the mains supply and the radio when not in use. The unit is only fully isolated from the mains if the AC adaptor is removed from the wall socket.

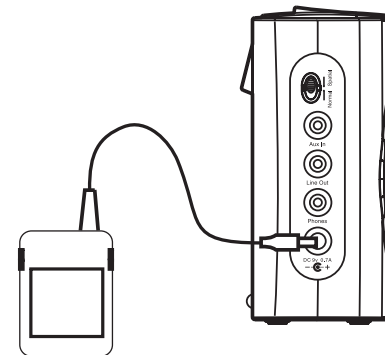

Operating your radio - DAB

1. Carefully extend the telescopic aerial.
2. Press the **On/Off button** to switch on your radio. The display will show "Welcome to Digital Radio" for a few seconds.
3. If this is the first time the radio is used a quick scan of UK Band III DAB channels will be carried out. The display will show "Now tuning". If the radio has been used before the last used station will be selected.
4. During Autotune, the display will show "Scanning" and as each group of stations is detected the station count will be updated. The bottom line of the display shows a bargraph indicating progress of the Autotune.
5. When the Autotune is completed the first station (in numeric-alpha order 0...9...A...Z) will be selected.
6. If the station list is still empty after the Autotune your radio will display "No signal".
7. If no signals are found it may be necessary to relocate your radio to a position giving better reception.



Welcome to
Digital Radio

Now tuning...

Scanning... 24
■■■■■■■■■■

1Xtra
BBC National

No signal

If you need any further advice, please call our Technical Helpline on :-
020 8758 0338 (Mon-Fri)

Selecting a station - DAB

1. The top line of the display shows the name of the station currently selected.
2. Rotate the **Tuning control** to scroll through the list of available stations. Stop rotating the tuning control when you find the station that you wish to hear.
3. Press and release the **Tuning control** to select the station. The display may show "Now tuning" while your radio finds the new station.
4. Adjust the **Volume control** to the required setting.

Note: If after selecting a station the display shows "Not Available" it may be necessary to relocate your radio to a position giving better reception.

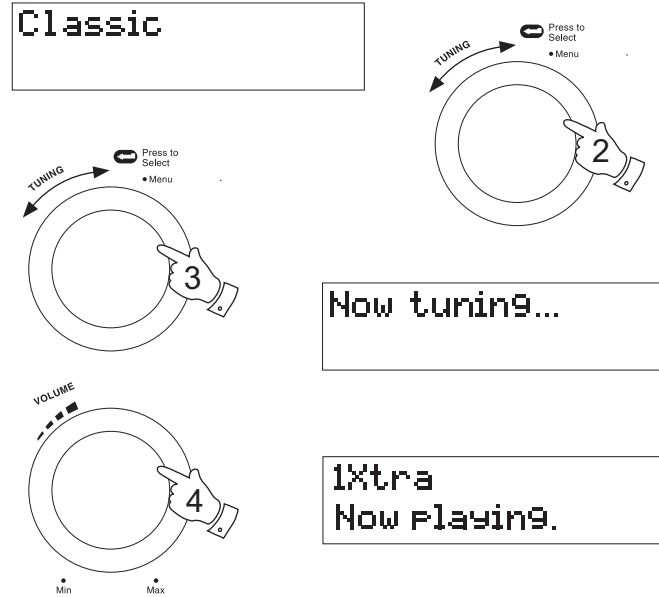

Secondary services - DAB

1. Certain radio stations have one or more secondary services associated with them. If a station has a secondary service associated with it the display will show ">" next to the station name on the station list. The secondary service will then appear immediately after the primary service when you rotate the tuning control clockwise.
2. Press and release the **Tuning control** to select the station.

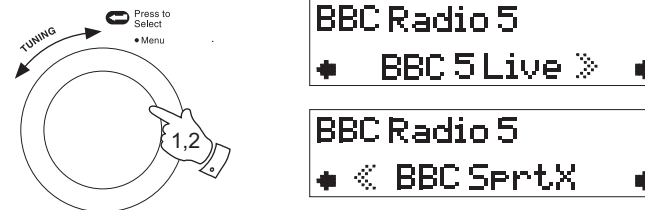

Display modes - DAB

Your radio has seven display modes:-

1. Press the **Advanced Info** button to cycle through the various modes.

- | | |
|----------------------------|-----------------------------------------------------------------------------------|
| a. Scrolling text | Displays scrolling text messages such as artist/track name, phone in number, etc. |
| b. Programme type | Displays type of station being listened to e.g. Pop, Classic, News, etc. |
| c. Multiplex name | Displays name of multiplex to which current station belongs. |
| d. Time and date | Displays current time and date. |
| e. Channel and frequency | Displays current channel and frequency. |
| f. Audio type and bit rate | Displays audio type and bit rate. |
| g. Signal strength | Displays signal strength for station being listened to. |



a
BBC 7
Just a Minute...

b
BBC 7
Culture

c
BBC 7
BBC National

d
BBC 7
19:17 08-06-2005

e
BBC 7
11C 220.35 MHz

f
BBC 7
128kbps Stereo

g
BBC 7
■■■■■□■■■■

If you need any further advice, please call our Technical Helpline on :-
020 8758 0338 (Mon-Fri)

Finding new stations - DAB

As time passes new stations may become available. To find new stations proceed as follows:-

1. Press and release the **Auto Tune button**, the display will show "Scanning". Your radio will perform a scan of the UK DAB frequencies. As new stations are found the station counter on the right-hand side of the display will increase and stations will be added to the list.
2. To carry out a full scan of the entire DAB Band III frequencies press and hold down the **Auto Tune button** for more than 2 seconds and then release. The display will show "Scanning". As new stations are found the station counter on the right-hand side of the display will increase and stations will be added to the list.



Manual tuning - DAB

Manual tuning allows you to tune directly to the various Band III DAB channels. UK DAB stations are currently located in the range 11B to 12D.

1. Press and hold down the **Tuning control**, "Station order" will appear on the display. Then rotate the **Tuning control** until the display shows "Manual tune". Press and release the **Tuning control**.
2. Rotate the **Tuning control** to select the required DAB channel.
3. Press and release the **Tuning control** to select the channel.
4. Rotate the **Tuning control** to select the stations contained within the Multiplex (group of stations) for the selected DAB channel.
5. Press and release the **Tuning control** to return to normal tuning mode.

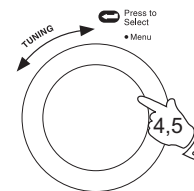
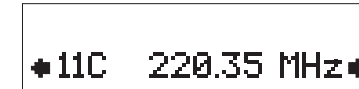
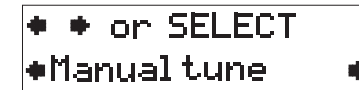
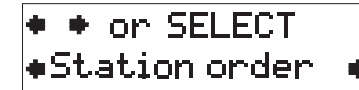
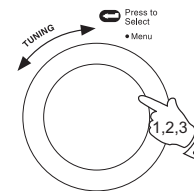

Signal strength display - DAB

1. Press and release the **Tuning control** until the lower line of the display shows the signal strength.
2. Position your radio and carefully angle the telescopic aerial for best reception using the signal strength display as a guide. Move your radio around and position to give maximum number of black rectangles on signal strength display. The clear unfilled rectangle indicates minimum signal level required for satisfactory reception.

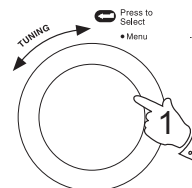

Presetting stations - DAB

There are 5 memory presets on each radio band DAB, FM and MW.

1. Press the **On/Off button** to switch on the radio.
2. Tune to the required station as previously described.
3. Press and hold down the required **Preset button** until the display shows e.g. "Preset 1 saved". The station will be saved under the chosen preset button. Repeat this procedure for the remaining presets.
4. Stations stored in preset memories may be overwritten by following the above procedure.

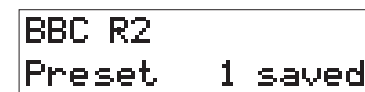
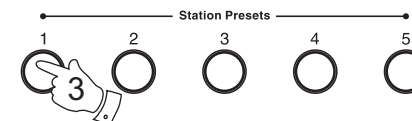

If you need any further advice, please call our Technical Helpline on :-
020 8758 0338 (Mon-Fri)

Recalling a preset station - DAB

1. Press the **On/Off button** to switch on your radio.
2. Select the required waveband by pressing the **Band button**.
3. Momentarily press the required **Preset button**, your radio will tune to the station stored in preset memory.

Note: If you have not previously stored a preset station and the preset buttons are pressed "Empty preset" will be displayed.

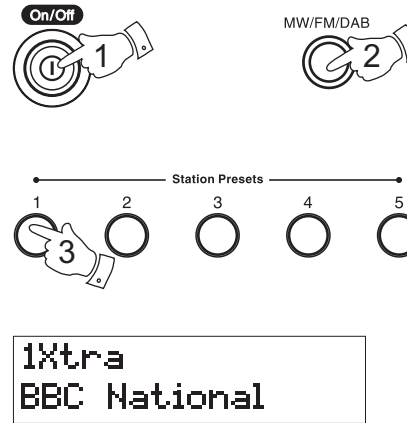

Station order setup - DAB

Your radio has 3 station order settings from which you can choose. The station order settings are, favourite station, alphanumeric and active station.

Note: Your radio default station order is alphanumeric.

1. Press and hold in the **Tuning control** until "Station order" appears on the display. Press and release the **Tuning control**.
2. Rotate the **Tuning control** to choose between favourite station, alphanumeric and active station.

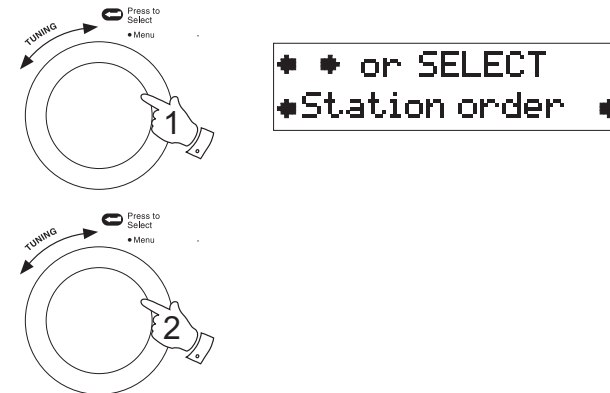

Favourite stations

When this setting is switched on, after a period of time the most listened to stations will move to the top of the station list and will be marked with the heart symbol ♥.



Alphanumeric

Rotate the **Tuning Control** until "Alphanumeric" appears on the display. Your radio will now select stations in alphanumeric order A....Z 0....9.



Active station

Rotate the **Tuning Control** until "Active station" appears on the display. The display will show only those that a signal can be found.

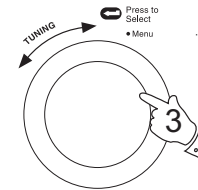

3. Press and release the **Tuning control** to select the station order setting required.

Prune stations

This option is only available when favourites has been selected on the station order.

Some DAB services may stop broadcasting or you may not be able to receive a station. Prune stations will delete the DAB stations from your station list that can no longer be received.

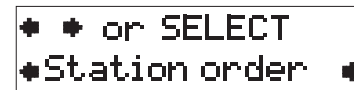
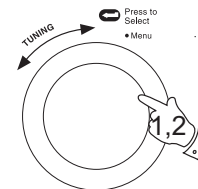

1. Press and hold in the **Tuning control** until "Station order" appears on the display. Press and release the **Tuning control**.
2. Rotate the **Tuning control** until "Prune stations" appears on the display. Press and release the **Tuning control** to select.



If you need any further advice, please call our Technical Helpline on :-
020 8758 0338 (Mon-Fri)

Dynamic Range Control (DRC) settings

DRC can make quieter sounds easier to hear when your radio is used in a noisy environment.

1. Press the **On/Off button** to switch on your radio.
2. Press and hold in the **Tuning control** until display shows "Station order."
3. Rotate the **Tuning control** until the display shows "DRC value".
4. Press and release the **Tuning control** to enter adjustment mode.
5. Rotate the **Tuning control** to select required DRC setting (default is 0).
 - DRC 0 DRC is switched off, Broadcast DRC will be ignored.
 - DRC 1/2 DRC level is set to 1/2 that sent by broadcaster.
 - DRC 1 DRC is set as sent by broadcaster.
6. Press and release the **Tuning control** to confirm the setting. The display will return to radio mode.

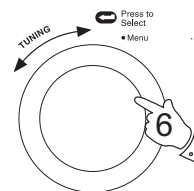
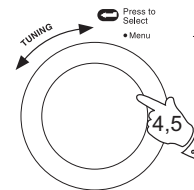
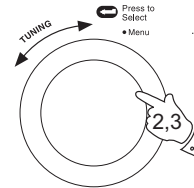

◆ ◆ or SELECT
◆ Station order ◆

◆ DRC value ◆

DRC0
◆ DRC0 ◆

DRC0
◆ DRC 1/2 ◆

DRC0
◆ DRC1 ◆

Software version

The software display cannot be altered and is just for your reference.

1. To view which software version your radio has press and hold in the **Tuning control** until "Station order" appears on the display.
2. Rotate the **Tuning control** to view the software version.

◆ U.17.2-2
◆ Sw Version ◆

Operating your radio - Search tuning FM and MW

1. Fully extend the telescopic aerial for FM reception. For MW there is a built in ferrite aerial. Rotate your radio for best reception.
2. Press the **On/Off** button to switch on your radio. The display will show "Welcome to Digital Radio" for a few seconds.
3. Press the **Band** button to select the FM or MW band.
4. Press and immediately release the **Auto tune** button, your radio will scan in an upwards direction (low frequency to high frequency) and stop automatically when it finds a station of sufficient strength.
5. After a few seconds the display will update. If the FM band is selected the display will show the station name.
6. To find other stations, press and release the **Auto tune** button as before.
7. To scan the FM or MW band in a downwards direction (high frequency to low frequency) press and hold down the **Auto tune** button for 0.5 seconds and then release.
8. When the waveband end is reached your radio will recommence tuning from the opposite waveband end.
9. Adjust the **Volume control** to the required setting.
10. To switch off your radio press the **On/Off** button.

If you need any further advice, please call our Technical Helpline on :-
020 8758 0338 (Mon-Fri)



Welcome to
Digital Radio



FM 89.30 MHz



RDS ST
BBC R2

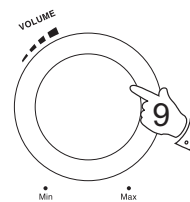

Manual tuning - FM and MW

1. Press the **On/Off button** to switch on your radio.
2. Press the **Band button** to select the FM or MW band. Fully extend the telescopic aerial for FM reception. For MW reception there is a built in ferrite aerial. Rotate your radio to the position giving best reception.
3. Rotate the **Tuning control** to tune to a station. The frequency will change in steps of 50 kHz on FM. On MW the frequency will change in steps of 9 kHz.
4. When the waveband end is reached the radio will recommence tuning from the opposite waveband end.
5. Set the **Volume control** to the desired settings.
6. To switch off your radio press the **On/Off button**.

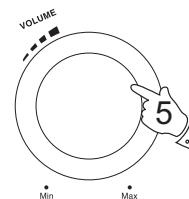
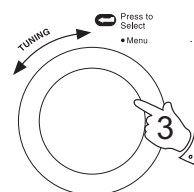

FM 89.30 MHz

MW 1584 kHz

Display modes - FM

Your radio has four display modes:-

The Radio Data System (RDS) is a system in which inaudible digital information is transmitted in addition to the normal FM radio programme. RDS offers several useful features. The following are available on your radio:-

1. Press the **Advanced Info button** to cycle through the various modes.

a. Frequency Displays the frequency of the station being listened to.

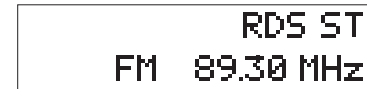

RDS ST
FM 89.30 MHz

b. Station name Displays the station name of the station being listened to.



RDS ST
BBC R2

c. Programme Type Displays type of station being listened to e.g. Pop, Classic, News, etc.



RDS ST
Easy listening

d. Scrolling text Displays scrolling text messages such as artist/track name, phone in number, etc.



RDS ST
Just a Minute...

Note: RDS features are available on the FM band only.

- If the station does not carry RDS information only the station frequency will be displayed and the display may show "NO PS, NO PTY or NO TEXT".

If you need any further advice, please call our Technical Helpline on :-
020 8758 0338 (Mon-Fri)

Presetting stations - FM and MW

1. Press the **On/Off button** to switch on the radio.
2. Tune to the required station as previously described.
3. Press and hold down the required **Preset button** until the channel number has stopped flashing on the display. The station will be stored under the chosen preset button. Repeat this procedure for the remaining presets.
4. Stations stored in preset memories may be overwritten by following the above procedure.

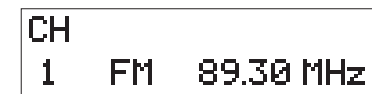
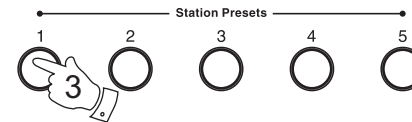

Recalling a preset station - FM and MW

1. Press the **On/Off button** to switch on your radio.
2. Select the required waveband by pressing the **Band button**.
3. Momentarily press the required **Preset button**, your radio will tune to the station stored in preset memory.

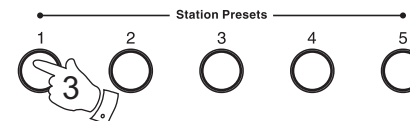

FM Stereo/Mono

1. If a station being received is weak some hiss may be audible. To reduce the hiss press and release in the **Tuning control** until the display shows "Audio mode : MONO" your radio will switch to mono mode.
2. To return to stereo mode press and release the **Tuning control** until the display shows "Audio mode : AUTO", your radio will switch to stereo mode.

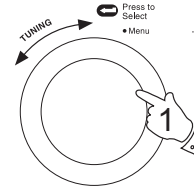

MONO

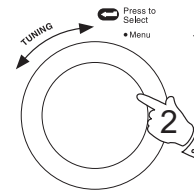

AUTO

Sleep function

The sleep function is operational on mains or battery.

1. Press the **On/off button** to switch on your radio.
2. Press in the **Advanced Info button** until "SLEEP-OFF" appears on the display and "SLEEP" will flash.
3. Repeatedly press and release the **Tuning control** until you reach the required sleep time. The sleep time can be adjusted in 10 minute increments up to a maximum of 90 minutes.
4. Press and release the **Tuning control** to confirm the sleep time settings.
Your radio will switch off after the preset sleep time has elapsed.

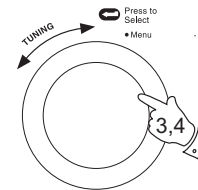

System reset

If your radio fails to operate correctly, or some digits on the display are missing or incomplete carry out the following procedure.

1. Switch on your radio.
2. Press and hold in the **Tuning control** until "Station order" appears on the display.
3. Rotate the **Tuning control** until the display shows "Factory reset".
4. Press in and release the **Tuning control**, the display will show "Press SELECT to confirm reset . . .".
5. Press the **Tuning control** to confirm. A full reset will be performed and all presets and station lists will be erased. A quick scan of UK DAB band III frequencies will be carried out.

If a problem persists our technical staff would be pleased to offer any assistance on operating the radio. Our technical helpline number is 020 8758 0338.

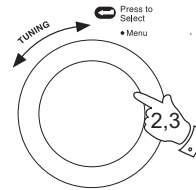

♦ ♦ or SELECT
♦ Station order ♦

♦ ♦ or SELECT
♦ Factory reset ♦

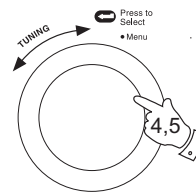

Press SELECT to
confirm reset...

Scanning... 24
■■■■■■■■■■

Display backlight

1. When your radio is powered by the AC adaptor the display backlight will always be switched on.
2. When powered by batteries the display backlight will only operate when the radio is switched on.

If you need any further advice, please call our Technical Helpline on :-
020 8758 0338 (Mon-Fri)

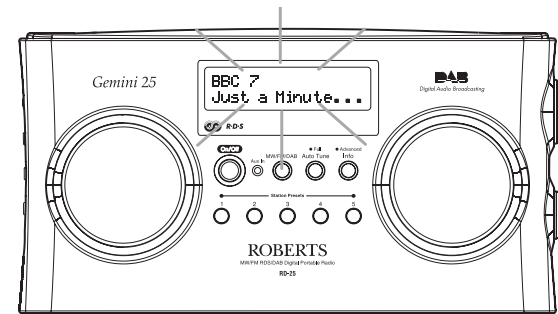

Auxiliary in socket

1. Connect a stereo or mono audio source (ie CD Walkman, iPod, MP3 player) to the **Auxiliary in socket**.
2. Press the **Band button** to select AUX band. The **Auxiliary in** LED indicator will light up.
3. Adjust the **Volume control** for comfortable listening.

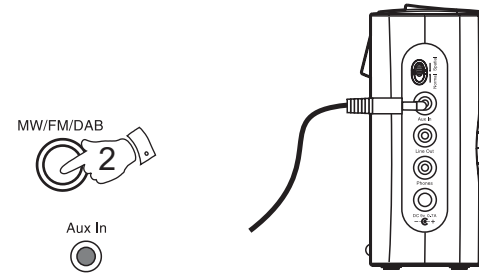

Line out socket

A 3.5mm **Line out socket** located on the left hand end of your radio is provided for connecting the audio signal to an external amplifier. Inserting a line out audio cable will not mute the internal loudspeaker. Set the volume control to the minimum if desired.

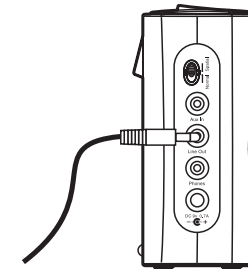

Headphone socket

A 3.5mm **Headphone socket** located on the left hand end of your radio is provided for use with either headphones or an earpiece. Inserting a plug automatically mutes the internal loudspeaker.

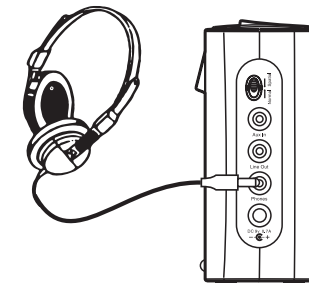

Spatial sound switch

Your radio speakers may be altered to give a normal or a spatial sound effect.

1. To give a normal sound, switch your **Spatial sound switch** to normal.
2. To give a wider stereo sound, switch your **Spatial sound switch** to spatial.



General

Do not allow this radio to be exposed to water, steam or sand. Do not leave your radio where excessive heat could cause damage such as in a parked car where the heat from the sun can build up even though the outside temperature may not seem too high.

Specifications

Power Requirements

AC adaptor AC 230 volts, 50Hz  only
Batteries 6 x LR14 (C size)

Battery Life

Approx. 20 hours on DAB and 50 hours on FM/MW, listening for 4 hours a day at normal volume using alkaline cells.

Frequency Coverage

DAB	174.928 - 239.200MHz
FM	87.50 - 108 MHz
MW	522 - 1710 kHz

Circuit features

Loudspeaker	2 x 89mm 8ohms
Output Power	2 x 1 Watt
Headphone socket	3.5mm dia
Aux in socket	3.5mm dia
Line out	3.5mm dia

Aerial System

DAB and FM	Telescopic aerial
MW	Built in ferrite aerial

If you need any further advice, please call our Technical Helpline on :-
020 8758 0338 (Mon-Fri)

Guarantee

This instrument is guaranteed for twelve months from the date of delivery to the original owner against failure due to faulty workmanship or component breakdown, subject to the procedure stated below. Should any component or part fail during this guarantee period it will be repaired or replaced free of charge.

The guarantee does not cover:

1. Damage resulting from incorrect use.
2. Consequential damage.
3. Receivers with removed or defaced serial numbers.

N.B. Damaged or broken telescopic aerials will not be replaced under guarantee.

Procedure:

Any claim under this guarantee should be made through the dealer from whom the instrument was purchased. It is likely that your Roberts' dealer will be able to attend to any defect quickly and efficiently but should it be necessary the dealer will return the instrument to the Company's service department for attention. In the event that it is not possible to return the instrument to the Roberts' dealer from whom it was purchased, please contact Roberts Radio Technical Services at the address shown below.

ROBERTS RADIO TECHNICAL SERVICES

97-99 Worton Road

Isleworth Middlesex

TW7 6EG

Technical Helpline :- 020 8758 0338 (Mon-Fri during office hours)

Website: <http://www.robertsradio.co.uk>



Issue 1

