

ROBERTS

Sound for Generations

RC9907

3 Band Radio Cassette
Recorder

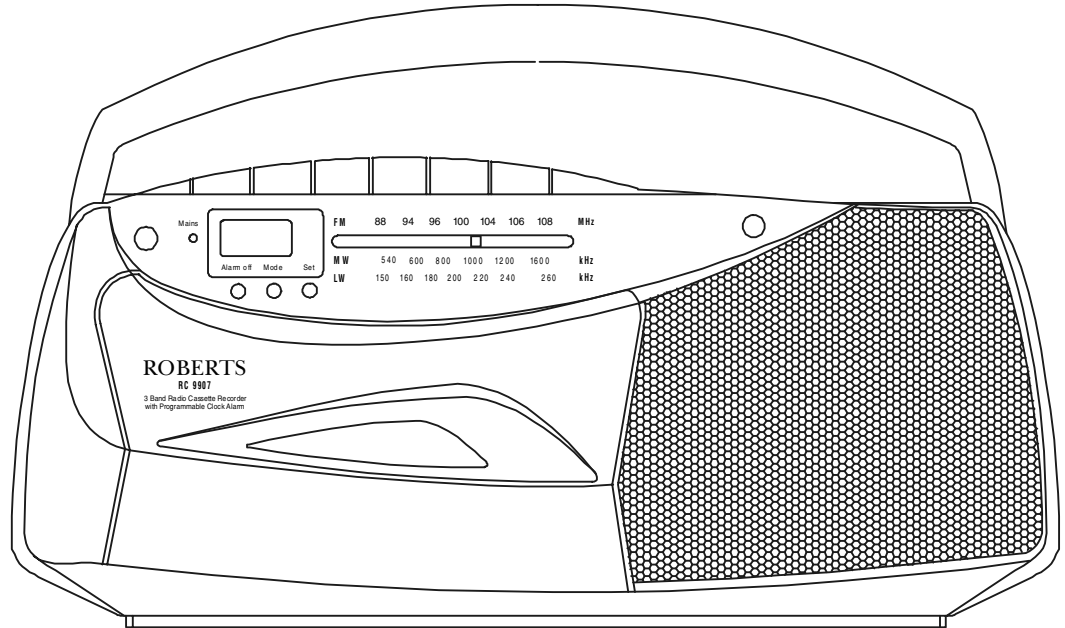

Please read this manual before use

Controls

(Top)

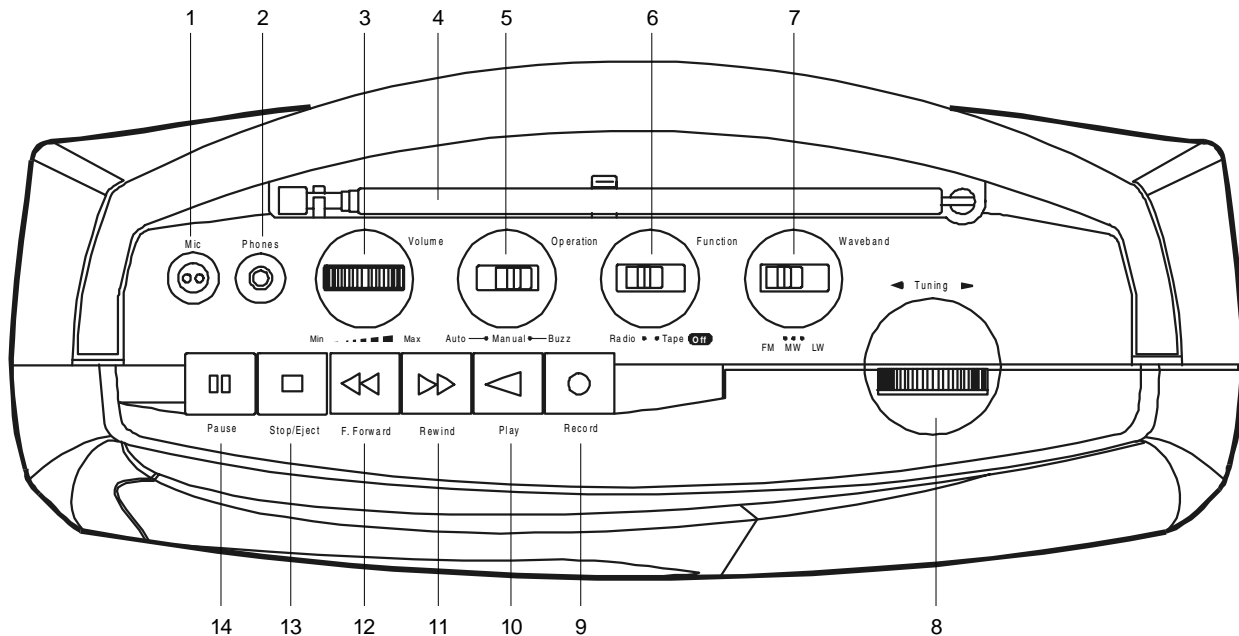

(Right side)

1. Microphone

2. Headphone socket

3. Volume control

4. Telescopic aerial

5. Operation switch

6. Function switch

7. Waveband switch

8. Tuning control

9. Record button

10. Play button

11. Rewind button

12. Fast forward button

13. Stop/eject button

14. Pause button

Controls (Front)

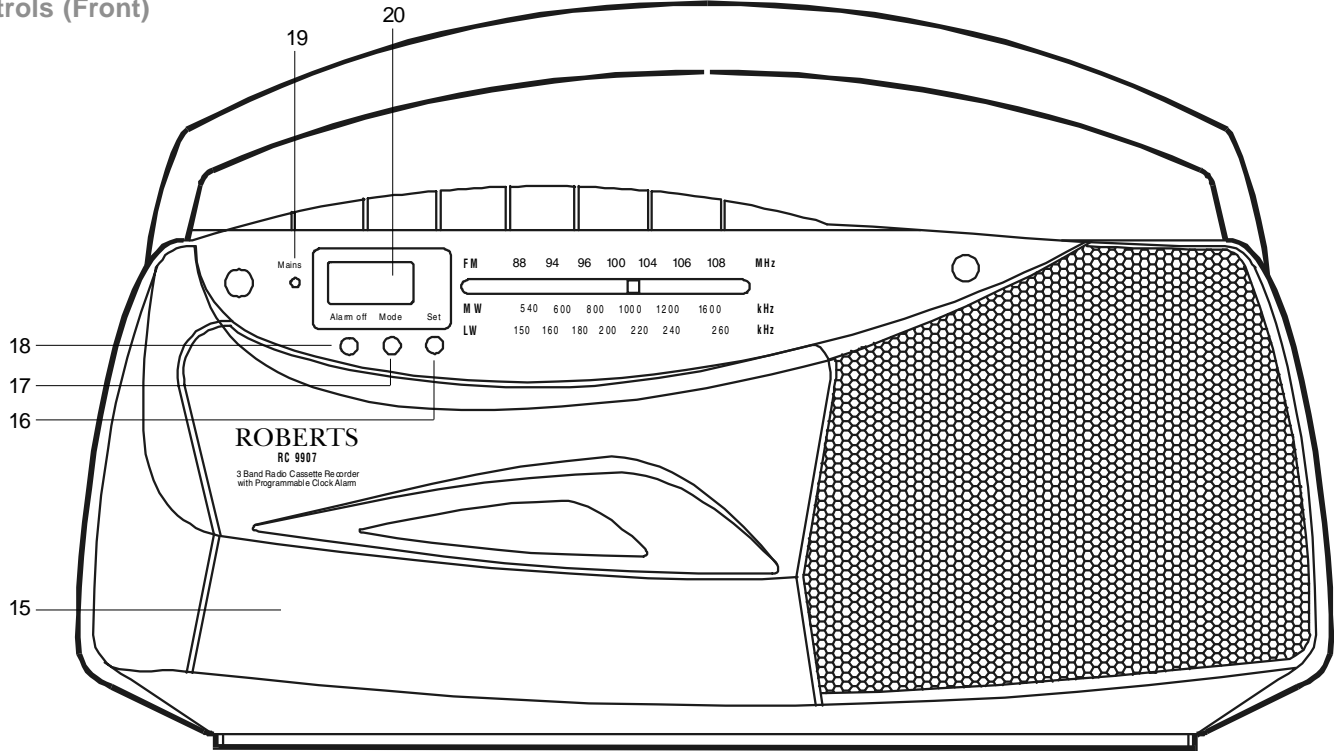

15. Cassette door

16. Set button

17. Mode button

18. Alarm off button

19. Mains indicator

20. Clock display.

Battery operation

IMPORTANT - The LR6 (AA size battery) must be fitted at all times to provide power for the clock.

1. Remove the **Battery cover** on the rear of the unit by pushing the catches in the direction of the arrow.
2. Insert one LR6 (AA size) battery into the small space in the battery compartment. The clock display will now appear. **The LR6 (AA size) battery provides power for the clock and must remain fitted at all times.**
3. Insert four LR14 (C size) batteries into the remaining spaces in the battery compartment. Take care to ensure all batteries are inserted with the correct polarity as shown inside the battery compartment. Replace the battery cover.
4. Reduced power, distortion, and a 'stuttering' sound are all signs that the batteries may need replacing.
5. If your radio cassette is not to be used for any extended period of time it is recommended that the batteries are removed from the radio.

We would recommend for economy, that the RC9907 is used on the mains whenever possible with battery operation for occasional or stand-by use only.

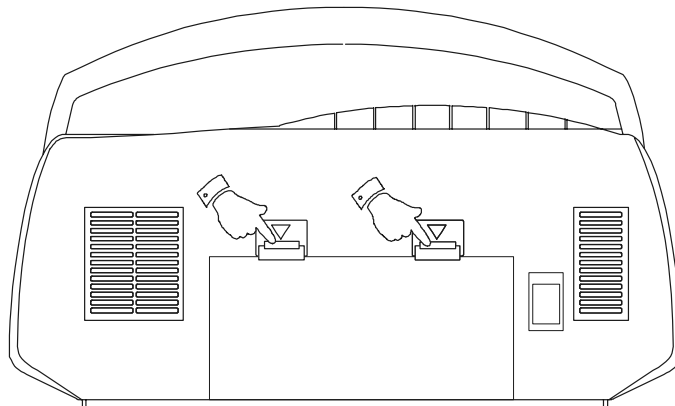

Mains operation

1. Place your radio cassette on a flat surface.
2. Plug the mains lead into the **Mains socket** located on the rear of your radio cassette ensuring that the plug is pushed fully into the socket.
3. Plug the other end into a wall socket and switch on. The **Mains indicator** will light up indicating that the radio is connected to the mains supply. The batteries will be automatically disconnected.

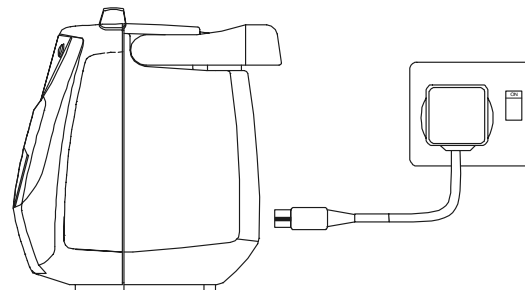

Listening to the radio

FM operation

1. Ensure that the **Operation switch** is in the 'Manual' position.
2. Set the **Function switch** to the 'Radio' position.
3. Select 'FM' using the **Waveband switch**.
4. Adjust the **Volume control** until a hissing sound is heard.
5. The **Telescopic aerial** (17) which is only operational on FM, should be fully extended.
6. Carefully tune to the desired station using the **Tuning control**.
7. Angle and rotate the **Telescopic aerial** to a position giving the best reception. A knuckle joint at the base of the aerial allows this movement and an angle of 45 degrees will usually be satisfactory. The FM band is marked in Megahertz (MHz).
8. To switch off the radio set the **Function switch** to the 'Tape Off' position.

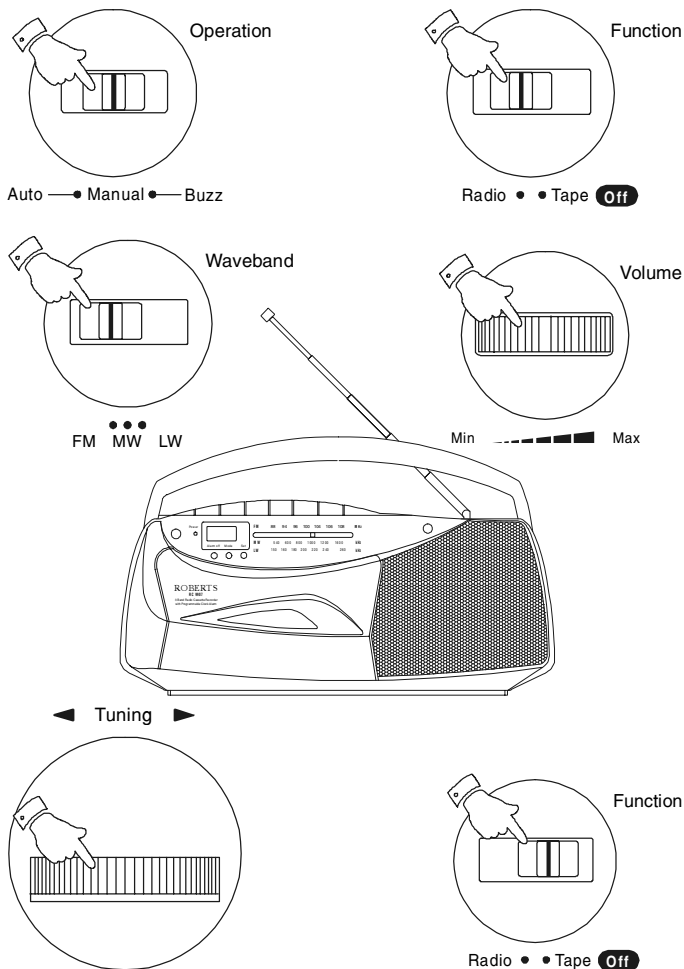

If you need any further advice, please call our Technical Helpline on :-
0181 758 0338 (Mon-Fri)

Medium and long wave operation

1. Ensure that the **Operation switch** is in the 'Manual' position.
2. Set the **Function switch** to the 'Radio' position.
3. Select 'MW' or 'LW' using the **Waveband switch**.
4. Adjust the **Volume control** until a hissing sound is heard.
5. Carefully tune to the desired station using the **Tuning control**.
6. Rotate your radio cassette for optimum reception.
7. The MW and LW bands are marked in kilohertz (kHz).
8. To switch off the radio set the **Function switch** to the 'Tape Off' position.

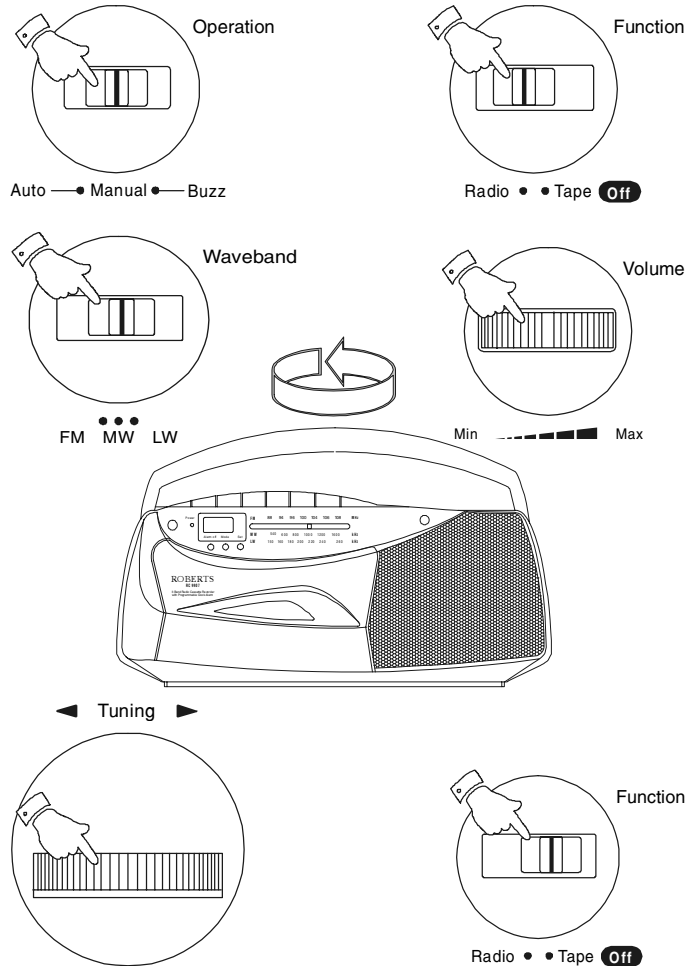

Listening to cassette tapes

1. Ensure that the **Operation switch** is in the 'Manual' position.
2. Set the **Function switch** to the 'Tape' position.
3. Press the **Stop eject button** to open the **Cassette compartment**.
4. Insert a pre-recorded cassette with the tape surface uppermost and the side with the desired recording facing towards you.
5. Close the **Cassette compartment**.
6. Depress the **Play button** and adjust the **Volume control** to suit your personal taste.
7. Use the **Fast forward** or **Rewind buttons** to locate a specific part of the tape.
8. If you wish to temporarily stop the playback depress the **Pause button**. When you are ready to resume playback press the **Pause button** a second time.
9. To stop the tape and switch off your radio cassette press the **Stop/Eject button**.

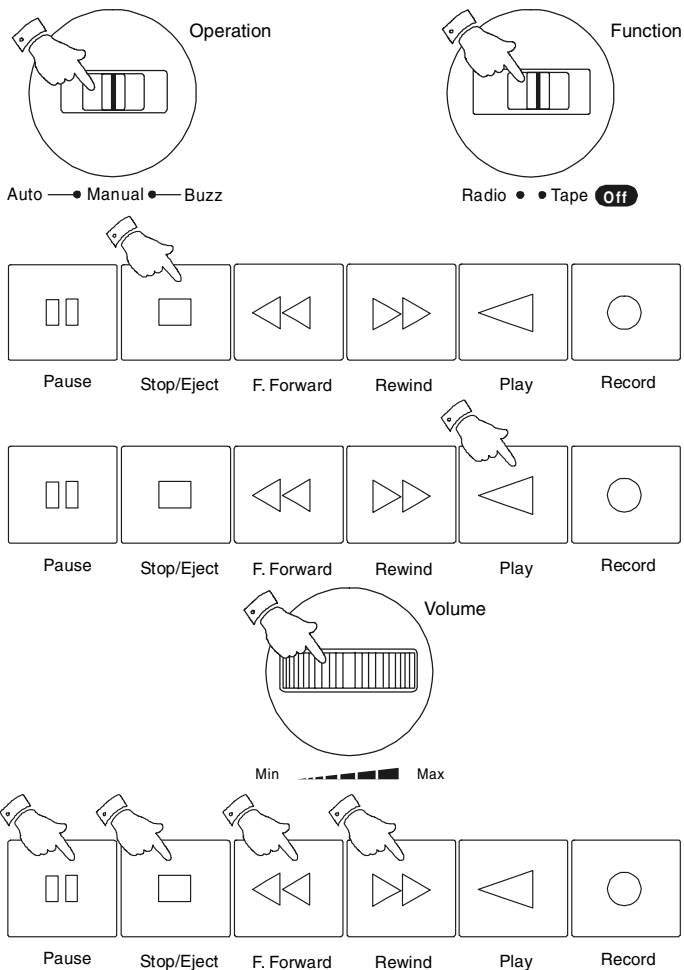

If you need any further advice, please call our Technical Helpline on :-
0181 758 0338 (Mon-Fri)

Recording from the Radio

1. Ensure that the **Operation switch** is in the 'Manual' position.
2. Set the **Function switch** to the 'Radio' position.
3. Tune in to the desired station.
4. Adjust the **Volume control** to suit your requirements.
6. Insert a blank cassette with the tape surface uppermost.
7. Depress the **Record button** to commence recording.
8. The recording level is set automatically and is not affected by the setting of the **Volume control**.
9. To stop the recording press the **Stop/Eject button**.

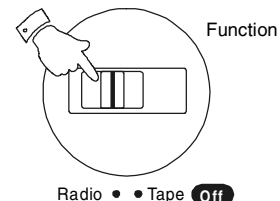
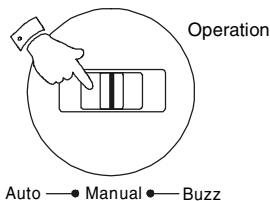

◀ Tuning ▶

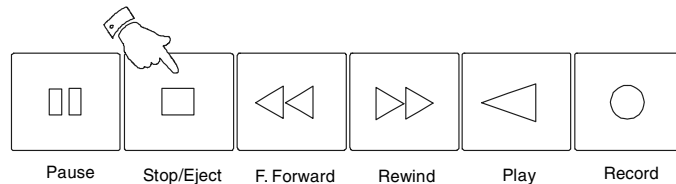
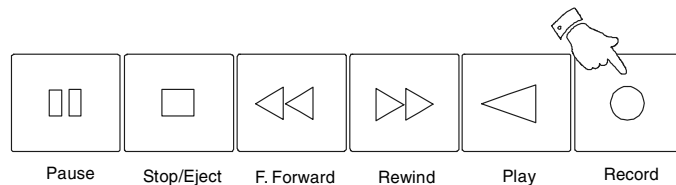
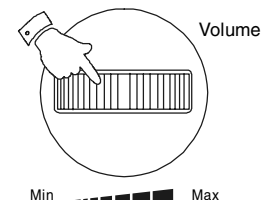
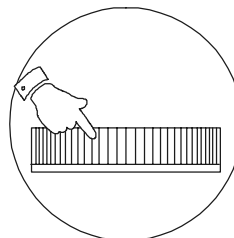

Recording from the Internal Microphone

1. Ensure that the **Operation switch** is in the 'Manual' position.
2. Set the **Function switch** to the 'Tape' position.
3. Insert a blank cassette with the tape surface uppermost.
4. Press the **Record button** to commence recording.

*Note : to reduce background noise it is important to speak as close as possible to the **Internal microphone** .*

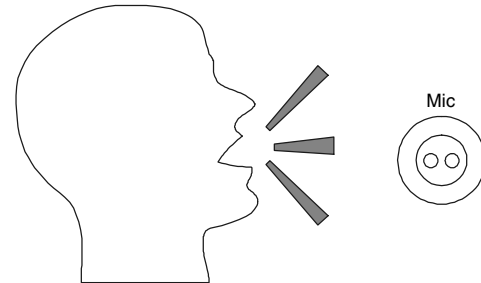
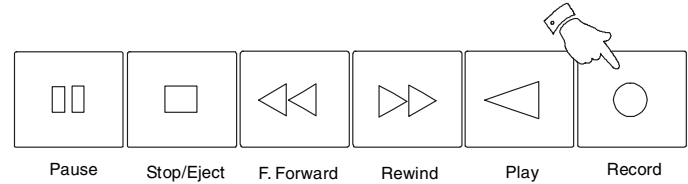
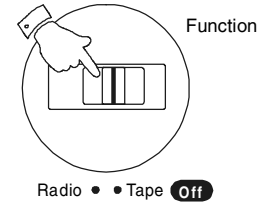
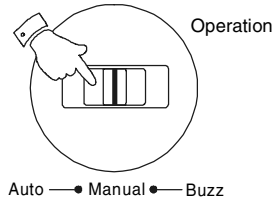

Setting the clock

1. Press the **Set button** six times, the display will show the hours digit.
2. Press the **Mode button** until the required hour is displayed.
3. Press the **Set button**, the display will show the minutes digit.
4. Press the **Mode button** until the required minute is displayed.
5. Press the **Set button** to return to the normal clock display.
6. Press the **Mode button** to start the clock at the selected time. The colon between the hours and minutes digit will flash showing that the clock is running.

Note : When setting the hours digit pressing and holding down the mode button until the hours digit has gone through midnight will change the clock to 24hr mode, this is indicated by the letter 'H' after the hours digit. To change back to 12hr mode repeat the procedure. 12hr mode is indicated by the letter 'A' for AM or 'P' for PM after the hours digit.

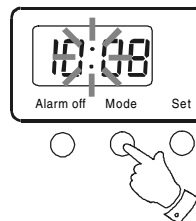
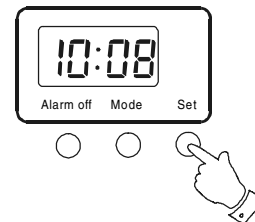
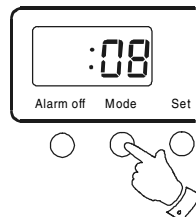
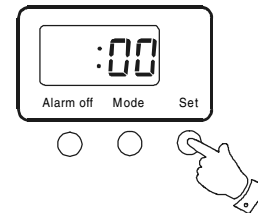
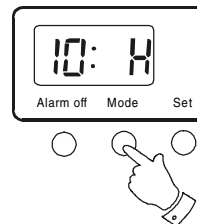
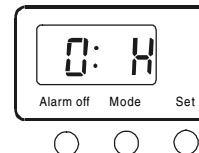
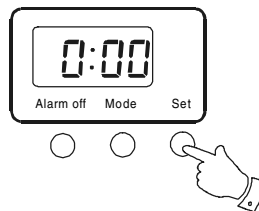

Setting the date

1. Press the **Set button** four times, the display will show the months digit.
2. Press the **Mode button** until the required month is displayed.
3. Press the **Set button**, the display will show the day of the month digit.
4. Press the **Mode button** until the required day of the month is displayed.
5. Press the **Set button** three times to return to the normal clock display.

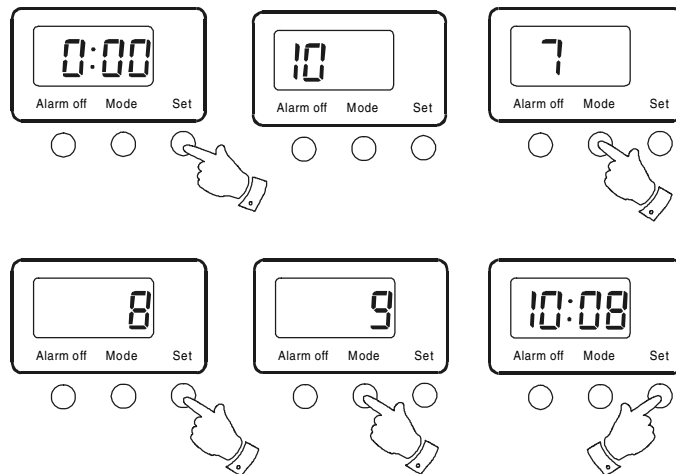

Setting the alarm time

1. Press the **Set button** twice, the display will show the hours digit .
2. Press the **Mode button** until the required hour is displayed.
3. Press the **Set button** the display will show the minutes digit.
4. Press the **Mode button** until the required minute is displayed.
5. Press the **Set button** to return to the normal clock display.

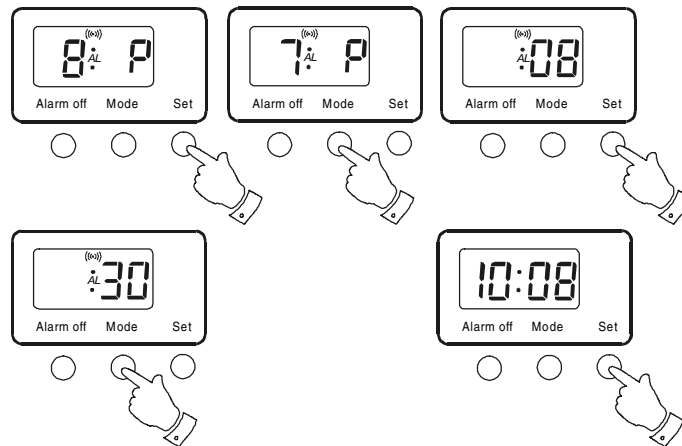

If you need any further advice, please call our Technical Helpline on :-
0181 758 0338 (Mon-Fri)

Setting the alarm to wake to buzzer

1. Set the alarm as previously described.
2. Set the **Operation switch** to the 'Buzz' position.
3. Press the **Set button** the hours and minutes digits will flash.
4. Repeatedly press the **Mode button** until the ((Ⓜ)) symbol is showing.
5. Press the **Set button** three times to return to the normal clock display. The radio will now turn on at the selected alarm time.
6. To cancel the alarm whilst the alarm is sounding press the **Alarm off button**.

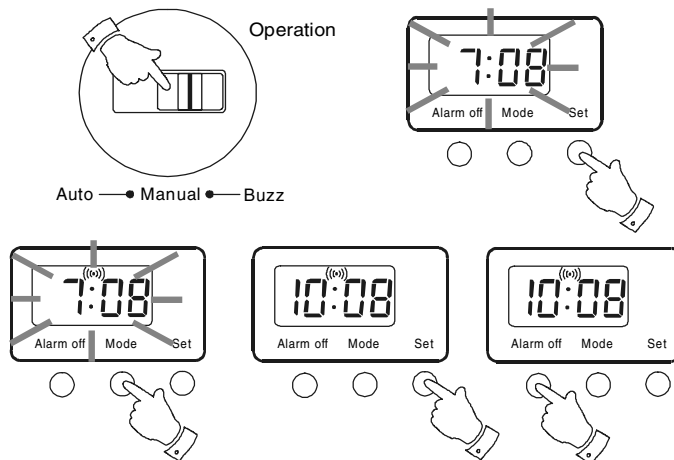

Setting the alarm to wake to radio

1. Set the alarm as previously described.
2. Tune in to the desired station, and adjust the volume to the required level.
3. Set the **Operation switch** to the 'Auto' position.
4. Press the **Set button** the hours and minutes digits will flash.
5. Repeatedly press the **Mode button** until the ((Ⓜ)) symbol is showing.
6. Press the **Set button** three times to return to the normal clock display. The radio will now turn on at the selected alarm time.
7. To cancel the alarm whilst the alarm is sounding press the **Alarm off button**.

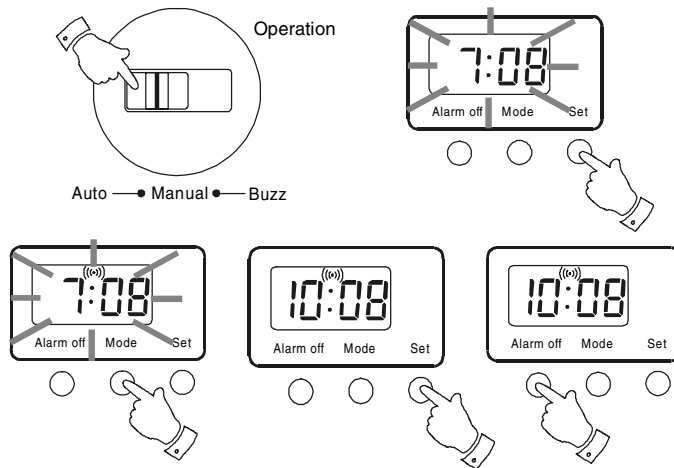

Making a timed recording

1. Tune in the station you wish to record at the preset time
2. Set the alarm to wake to radio as previously described.
3. Insert a blank cassette into the **Cassette compartment**.
4. Ensure that the **Operation switch** is set to the 'Auto' position
3. Press the **Record button**.
4. The radio will turn on at the preset alarm time. The tape will stop when tape end is reached.

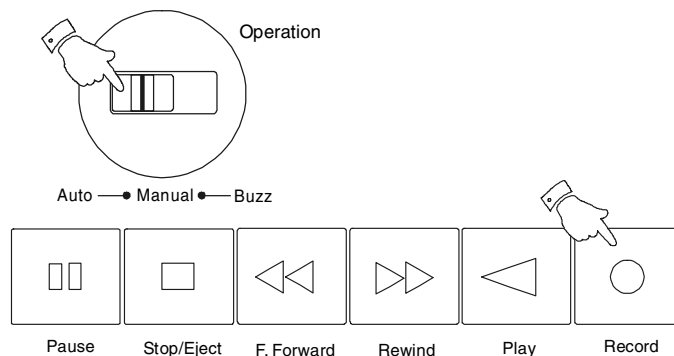

Activating the hourly alarm

1. Press the **Set button**, the hours and minutes digits will flash.
2. Repeatedly press the **Mode button** until the  symbol is showing.
3. Press the **Set button** three times to return to the normal clock display.
4. Set the **Operation switch** to the Buzz position. The alarm will now beep on each hour.

Note : this function is not available if either the radio or tape functions are being used.

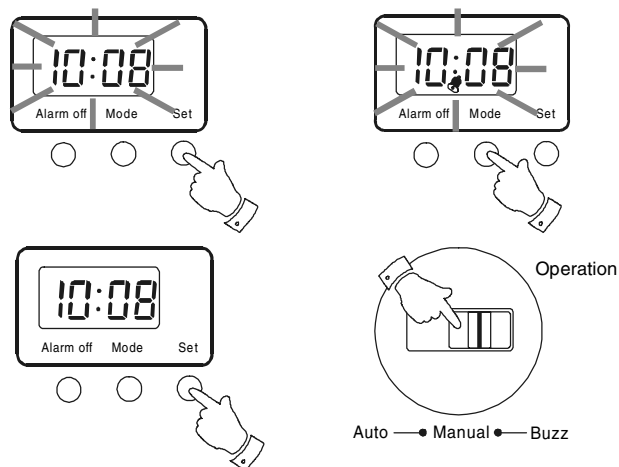

Displaying the alarm time

1. Whilst the current time is displayed press the **mode button** once. The alarm time stored will be displayed; after approximately two seconds the display will automatically switch back to current time.

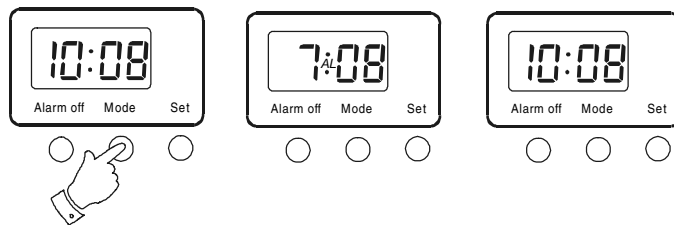

Displaying the date

1. Whilst the current time is displayed press the **Mode button** twice. The date will be displayed; after approximately two seconds the display will automatically switch back to current time.

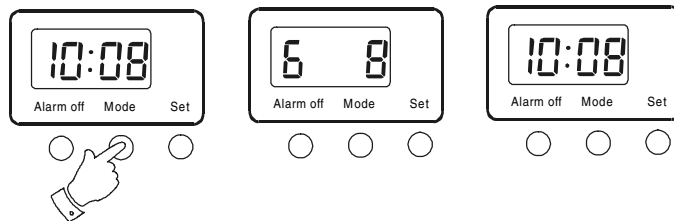

Displaying the seconds

1. Whilst the current time is displayed press the **Mode button** three times. The seconds will be displayed.
2. Press the **Mode button** to switch back to current time.

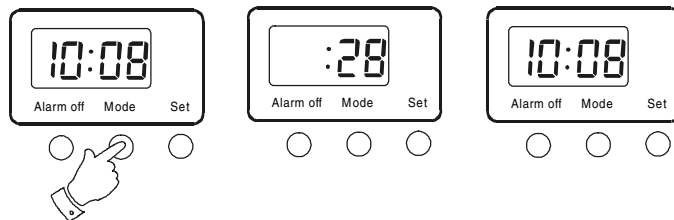

Headphones socket

A 3.5mm **Headphone Socket** located on the top of your radio cassette is provided for use with either headphones or an earpiece. Inserting a plug into the socket automatically mutes the internal loudspeaker.



Preventing accidental erasure

To safeguard your recordings against accidental erasure, break off the appropriate tab on the cassette as shown. There is one tab for each side of the cassette. This will prevent the Record button from being pressed. To restore the cassette to normal, seal the tab openings with a small piece of self-adhesive tape.

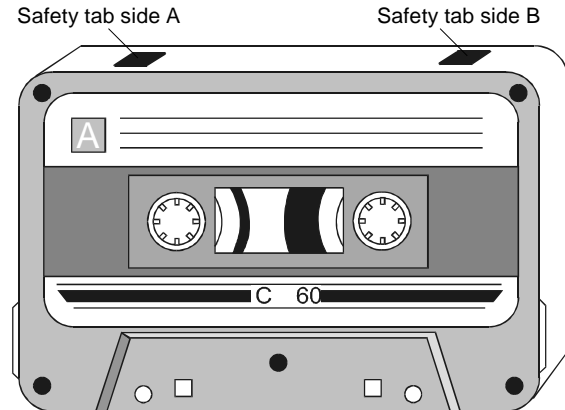

*If you need any further advice, please call our Technical Helpline on :-
0181 758 0338 (Mon-Fri)*

Cleaning the Heads

The binder and oxide from magnetic tapes can accumulate on the pinch roller (A) the capstan shaft (B) and also the heads (C and D). This will impair the sound quality.

To clean these parts proceed as follows:-

1. Turn off the power to the unit.
2. Press the Stop/Eject button (3).
3. Press the Play button (6) and the heads will be clearly seen.
4. Clean the surfaces (A, B, C, D) with a lint free rag or cotton swab soaked in alcohol. Press the stop/eject button as soon as cleaning is over.

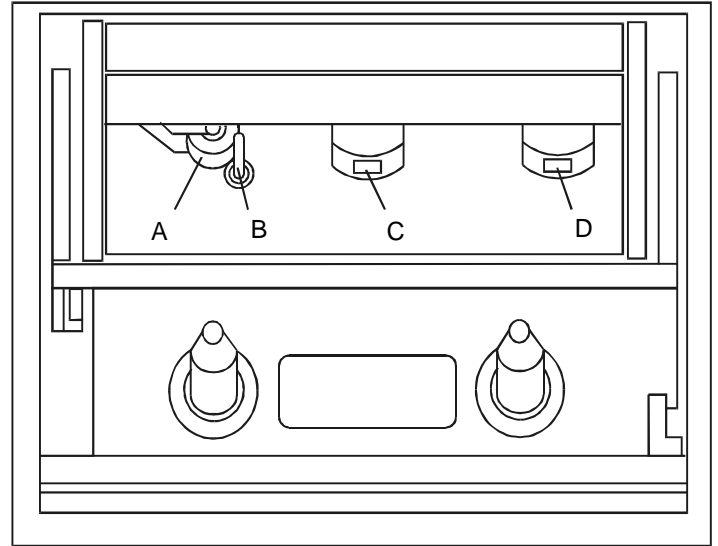

General

Do not allow this unit to be exposed to water or steam. It is recommended that the FM band be used wherever possible as better results in terms of quality and freedom from interference will usually be obtained than on the MW or LW bands.

Mains supply

The RC9907 will operate from a supply of AC 230 volts, 50Hz only.

DO NOT cut off the mains plug from this equipment. If the plug fitted is not suitable for the power points in your home or the cable is too short to reach a power point, then obtain an appropriate safety approved extension lead or adaptor. If in doubt consult your dealer.

If nonetheless the mains plug is cut off, remove the fuse and dispose of the plug immediately, to avoid a possible shock hazard by inadvertent connection to the mains supply.

If this product is not supplied with a mains plug, or one has to be fitted, then follow the instructions given below:

IMPORTANT. DO NOT make any connection to the larger terminal which is marked with the letter E or by the safety earth symbol \perp or coloured Green or Green-and-yellow.

The wires in the mains lead are coloured in accordance with the following codes :-

BLUE - NEUTRAL

BROWN - LIVE

The wire coloured BLUE must be connected to the terminal marked N or coloured BLACK.

The wire coloured BROWN must be connected to the terminal marked L or coloured RED.

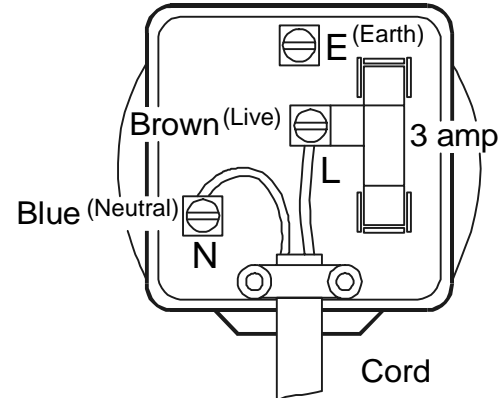

Fuse

When replacing the fuse only a 3A ASTA approved to BS1362 type should be used and be sure to re-fit the fuse cover.

IF IN DOUBT - CONSULT A QUALIFIED ELECTRICIAN.

Replacement fuse holders are available from Roberts Radio Technical Services Department at the address shown on the rear of this manual.

Specifications

Power Requirements

Mains:	AC 230 volts, 50Hz  only
Batteries:	Radio/Cassette 4 x LR14 (C size) Clock Battery 1 x LR6 (AA size)

Frequency Coverage

FM	87.5 - 108MHz
MW	525 - 1610kHz
LW	150 - 260kHz

Circuit Features

Loudspeaker	75mm diameter
	Output power 700mW
Aerial System	FM Wire Aerial
	MW Built-in Ferrite aerial
	LW Built-in Ferrite aerial

ROBERTS RADIO LIMITED

PO BOX 130
MEXBOROUGH
SOUTH YORKSHIRE
S64 8YT

The Company reserves the right to amend the specification without notice.

Guarantee

This instrument is guaranteed for twelve months from the date of delivery to the original owner against failure due to faulty workmanship or component breakdown, subject to the procedure stated below. Should any component or part fail during this guarantee period it will be repaired or replaced free of charge.

The guarantee does not cover:

1. Damage resulting from incorrect use.
2. Consequential damage.
3. Receivers with removed or defaced serial numbers.

N.B. Damaged or broken telescopic aerials will not be replaced under guarantee.

Procedure:

Any claim under this guarantee should be made through the dealer from whom the instrument was purchased. It is likely that your Roberts' dealer will be able to attend to any defect quickly and efficiently, but should it be necessary the dealer will return the instrument to the company's service department for attention. In the event that it is not possible to return the instrument to the Roberts' dealer from whom it was purchased, please contact Roberts Radio Technical Services department at the address shown on the rear of this manual before taking further action.

These statements do not affect the statutory rights of a consumer.

ROBERTS RADIO TECHNICAL SERVICES DEPARTMENT

97-99 Worton Road

Isleworth Middlesex

TW7 6EG

Technical Helpline:- 0181 758 0338 *(Mon-Fri)*

Issue 1

