



# ROBERTS

Sound for Generations

## R979

3 Band Digital PLL RDS Radio  
with Clock & Alarm

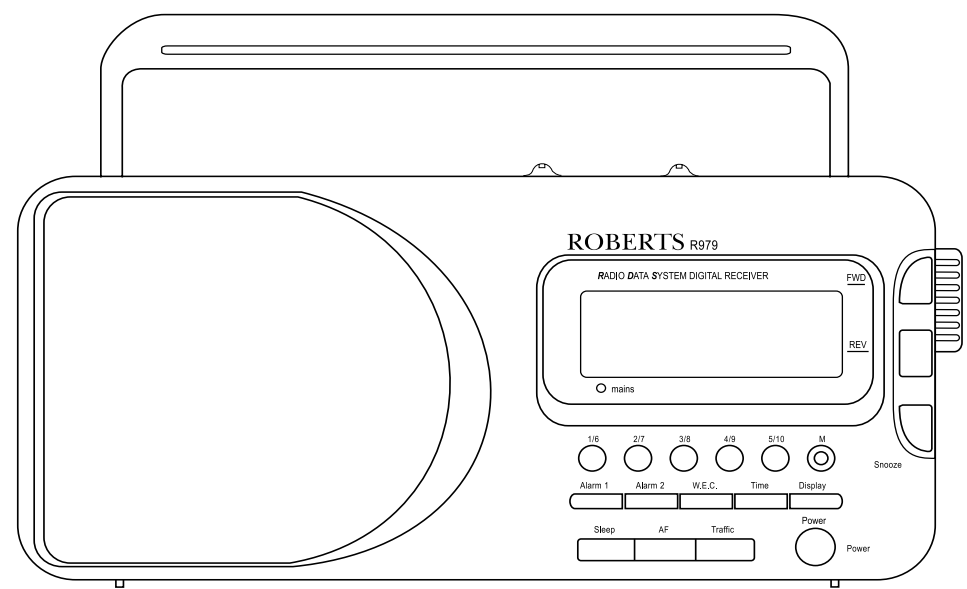

Please read this manual before use



## Controls

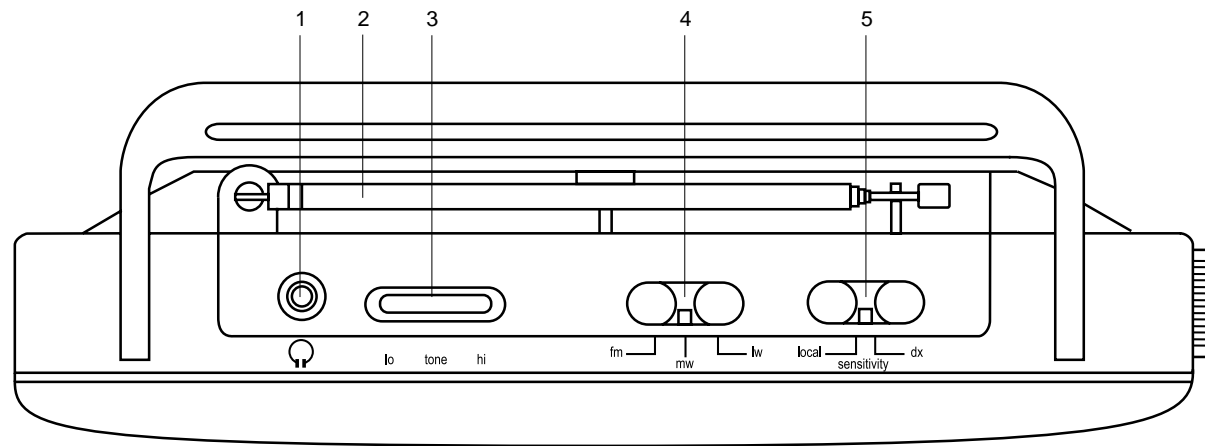

1. Headphone socket
2. Telescopic aerial
3. Tone control

4. Waveband switch
5. Sensitivity switch



### Controls (cont.)

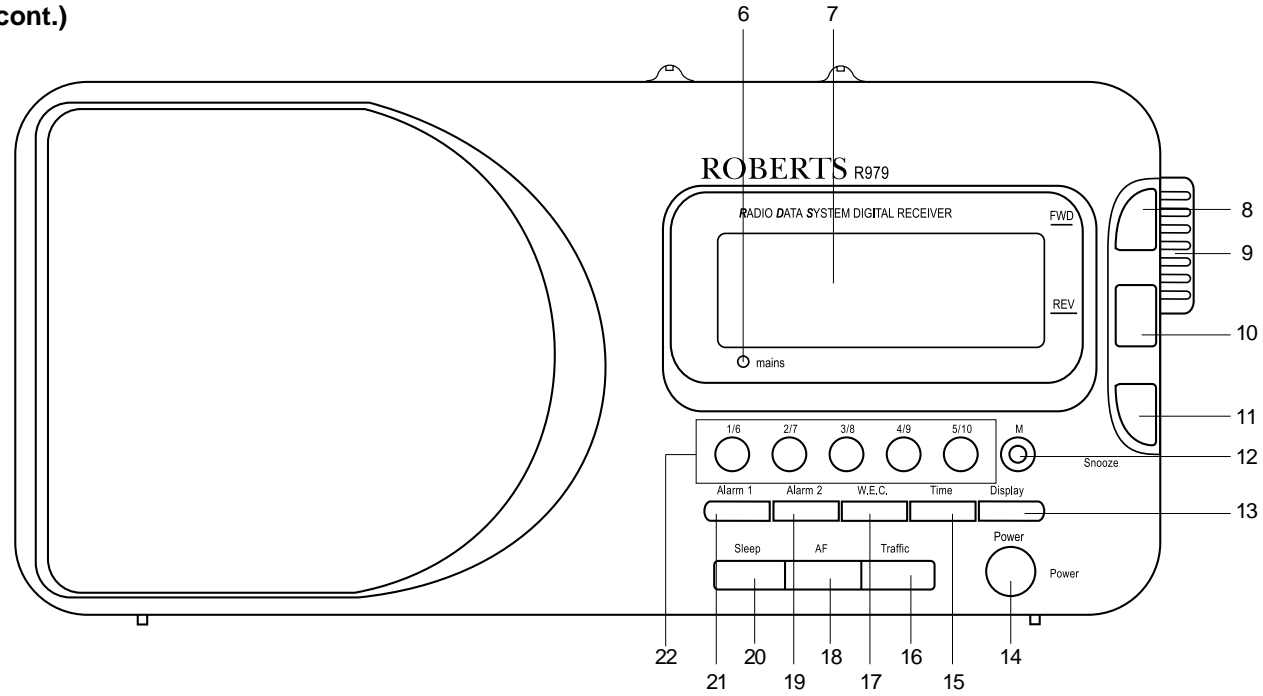

- |                           |                    |                           |                                |
|---------------------------|--------------------|---------------------------|--------------------------------|
| 6. Mains indicator        | 10. Reverse button | 14. Power button          | 18. Alternate frequency button |
| 7. Liquid crystal display | 11. Snooze button  | 15. Time button           | 19. Alarm 2 button             |
| 8. Forward button         | 12. Memory button  | 16. Traffic button        | 20. Sleep button               |
| 9. Volume control         | 13. Display button | 17. Weekend cancel button | 21. Alarm 1 button             |





### Controls (cont.)

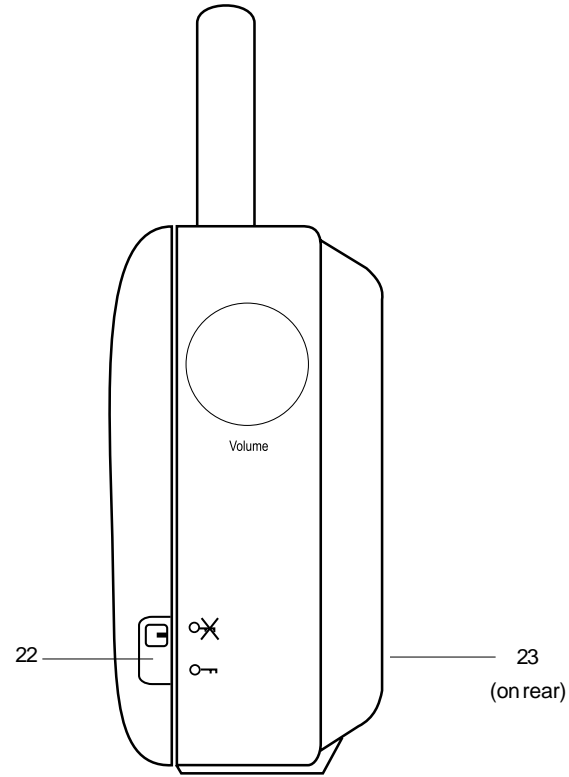

- 22. Lock switch
- 23. Battery compartment

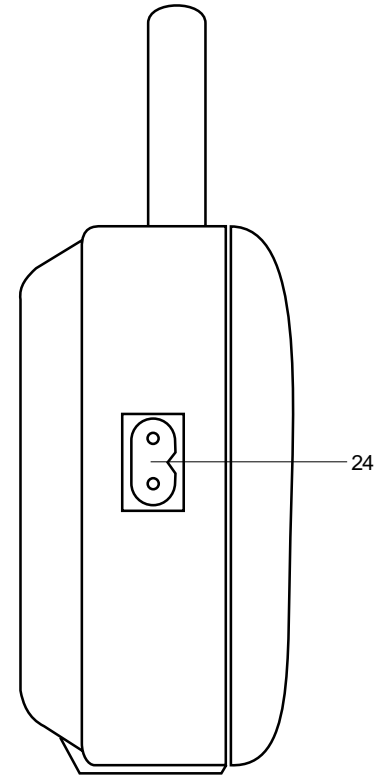

- 24. Mains input socket





## General

Do not allow this radio to be exposed to water, steam or sand. Do not leave the radio where excessive heat could cause damage such as in a parked car where the heat from the sun can build up even though the outside temperature may not seem too high. It is recommended that the FM band be used where ever possible as better results in terms of quality and freedom from interference will usually be obtained than on the MW or LW bands.

## Mains supply

The R979 will operate from a supply of 230 volts, 50Hz  only.

**DO NOT cut off the mains plug from this equipment.** If the plug fitted is not suitable for the power points in your home or the cable is too short to reach a power point, then obtain an appropriate safety approved extension lead or adaptor. If in doubt consult your dealer.

If nonetheless the mains plug is cut off, remove the fuse and dispose of the plug immediately, to avoid a possible shock hazard by inadvertent connection to the mains supply.

If this product is not supplied with a mains plug, or one has to be fitted, then follow the instructions given below:

**IMPORTANT. DO NOT** make any connection to the larger terminal which is marked with the letter E or by the safety earth symbol  or coloured Green or Green-and-yellow.

The wires in the mains lead are coloured in accordance with the following codes :-

BLUE - NEUTRAL

BROWN - LIVE

As these colours may not correspond with the coloured markings identifying the terminals in your plug, proceed as follows:

The wire coloured BLUE must be connected to the terminal marked N or coloured BLACK.

The wire coloured BROWN must be connected to the terminal marked L or coloured RED.

## Fuse

When replacing the fuse only a 3A ASTA approved to BS1362 type should be used and be sure to re-fit the fuse cover.

IF IN DOUBT - CONSULT A COMPETENT ELECTRICIAN.

Replacement fuse holders are available from Roberts Radio Technical Services Department at the address shown on the rear of this manual.

## Batteries

Remove the battery cover [23] on the rear of the radio by pushing the catch in the direction of the arrow. Remove the small cover inside the battery compartment by pushing the cover towards the bottom of the radio. Lift up the bottom edge of the cover and insert two IEC size LR6 (AA size) cells into the spaces in the compartment. Take care to ensure all cells are inserted with the correct polarity as shown inside the battery compartment. Replace the cover.

*Note : the two LR6 cells provide power for the clock / memory backup and must be fitted at all times.*

Insert four IEC size LR14 (C size) cells into the spaces in the compartment. Take care to ensure all cells are inserted with the correct polarity as shown inside the battery compartment. Replace the battery cover.

Reduced power, distortion, and a 'stuttering' sound are all signs that the batteries may need replacing.

**We would recommend for economy, that the R979 is used on the mains whenever possible with battery operation for occasional or stand-by use only.**

## Automatic Mains/Battery switching

To change from battery to mains operation, simply plug the mains lead into the mains input socket [24] on the left hand end of the radio. Mains operation is shown by the mains indicator [6]. The batteries will be automatically disconnected. It does not matter which way round the plug is inserted but make sure it is fully pushed home. The other end should be plugged into a domestic supply socket.







## Lock switch



The R979 is fitted with a lock switch [22] to prevent accidental operation. Before operating the radio slide the lock switch up to unlock the radio. To prevent operation when travelling or during storage, slide the lock switch down to lock the radio. Pressing any of the control buttons with the safety lock switched on will cause the display to show **LOCKED**.

## Automatic clock set (operates on FM only)

The clock time and day of week can be set automatically when receiving an RDS station that transmits clock time (CT). The CT information is transmitted once every minute. If the station has sufficient signal strength the clock will set within one or two minutes.

1. Press the power button [14] to switch on the radio.
2. Select the FM waveband using the waveband switch [4].
3. Fully extend the telescopic aerial [2].
4. Set the sensitivity switch [5] to the "dx" position.
5. Repeatedly press the time button [15] until the auto time set symbol  appears in the liquid crystal display [7].
6. Press and hold down the forward [8] or reverse tuning buttons [10] until the frequency in the liquid crystal display [7] begins to change, release the button.

The radio will now start to search the FM waveband and will stop when it finds a station of sufficient strength. If the station is of sufficient strength the  symbol will light up in the liquid crystal display.

The auto time set indicator  will flash in the liquid crystal display indicating that the radio is waiting for the RDS time signal. The  indicator will stop flashing when the time is set. If the clock does not set within three to four minutes, the radio station may not be transmitting clock time (CT) information - try tuning to another radio station.

The clock time and day of week are updated each time the radio is switched on and whilst listening to an RDS station transmitting clock time (CT) information.

## Manual clock set

The clock time and day of the week can be set manually.

1. Press the power button [14] to switch on the radio.
2. Repeatedly press the time button [15] until the auto time set symbol  disappears from the liquid crystal display [7].
3. Press the power button [14] to switch off the radio.
4. Press and hold down the time button [15].
5. Set the clock time using the forward [8] or reverse [10] buttons. A single press on the forward or reverse button will advance or retard the time in one minute steps. If the forward or reverse buttons are held down the time will advance or retard rapidly.

## Manual day of week set

1. Ensure that the radio is switched off.
2. Press and hold down the snooze button [11].
3. Set the day of week using the forward [8] or reverse [10] buttons. A single press on the forward or reverse button will advance or retard the day in one day steps. If the forward or reverse buttons are held down the day of week will advance or retard rapidly.

## Setting the alarm time

Your radio allows you to set two different alarm times. Each alarm can be independently set so as to allow you to wake to either the radio or buzzer.

1. Press and release the alarm 1 [21] or alarm 2 [19] button. The display will show the last pre-set alarm time.
2. Press and hold down the alarm 1 or alarm 2 buttons and set the alarm time using the forward or reverse buttons.

## Displaying the alarm times

1. Ensure that the radio is switched off.
2. Press the display button [13] once for alarm 1 and twice for alarm 2. The display will automatically return to showing clock time after three seconds.





## Wake up to radio

1. Press the power button [14] to switch on the radio.
2. Select a station that will be broadcasting at the desired alarm time and adjust the volume to the required level using the volume control [9].
3. Press the power button [14] to switch off the radio.
4. Set the alarm 1 or alarm 2 time as previously described.
5. Repeatedly press the alarm 1 or alarm 2 button until the radio alarm indicator (🎵1 or 🎵2) appears in the display.

At the pre-selected alarm times the radio will switch on and switch off automatically after 90 minutes.

Whilst the alarm is sounding the alarm indicator will flash in the display.

## Wake up to buzzer

1. Switch off the radio with the power button [14].
2. Set the alarm 1 or alarm 2 time as previously described.
3. Repeatedly press the alarm 1 or alarm 2 button until the buzzer alarm indicator (🔔1 or 🔔2) appears in the display.

At the pre-selected alarm times the buzzer will switch on and switch off automatically after 90 minutes.

Whilst the alarm is sounding the alarm indicator will flash in the display.

## Snooze function

1. The Radio or Buzzer alarms can be silenced for 5 minutes by pressing the “**Snooze**” button. This sequence can be repeated several times within the 90 minute alarm period.
2. The alarm indicator will flash in the display.
3. To turn off the radio or buzzer alarm until the next day, press and release the “**Power**” button.

## Switching off the alarm

1. Whilst the alarm is sounding it can be turned off until the next day by pressing the power button [14].
2. If you wish to turn off the alarms permanently, repeatedly press the alarm 1 or alarm 2 buttons until the alarm indicators disappear from the display.

## Week end cancel (W.E.C.)

If you do not wish to be woken up by the alarm on weekends, press the W.E.C. button [17] once.

The **WEC** indicator will appear in the display and the alarm will sound on weekdays only.

Press the W.E.C. button to switch off this function. The **WEC** indicator will be removed from the display.

*Note:* the week end cancel function applies to both alarm 1 and alarm 2.

## Going to sleep whilst listening to the radio

1. Press and release the sleep button [20] the radio will switch on and display the sleep time remaining.
2. Whilst the sleep time is showing press and hold down the sleep button to adjust the sleep time, release the sleep button when the required sleep time is reached.

The sleep time can be adjusted from a maximum of 90 minutes down to a minimum on 10 minutes and can be cancelled by pressing the power button.



## Radio operation

### Sensitivity switch.

For normal operation set the sensitivity switch [5] to the 'dx' position. When listening to a strong stations the signal may become slightly distorted, set the sensitivity switch [5] to the 'local position' to improve reception.

*Note : the sensitivity switch is operational on the FM band only.*

### Search Tuning

1. Switch on the radio and select the required waveband.
2. Press and hold the forward tuning button [8] or the reverse tuning button [10] until the frequency in the display starts to change continuously. Release the button.
3. The radio will continue searching until a station of reasonable strength is found.
4. To search for additional stations it is only necessary to repeat the above operation.
5. Automatic search tuning may be stopped by a single press of either the tuning up [8] or tuning down [10] buttons.
6. Adjust the volume [9] and tone [3] controls to the required settings

### Manual tuning

1. Switch on the radio and select the required waveband.
2. Intermittently press the forward tuning button [8] or reverse tuning button [10] until the desired frequency is reached. Each step is equal to 50kHz on FM - 9kHz on MW - and 1kHz on LW.

### Memory presets

You may store up to 10 different frequencies on each of the 3 wavebands providing a total of 30 preset stations.

1. Select the desired waveband using the waveband switch [4] located on the top panel.
2. Tune in to the desired frequency using search or manual tuning as described above.

3. When the desired station is tuned in, press and release the 'M' button [12] the display will flash **MEMORY** for 8 seconds during which time you can store a station in one of the memory pre-sets.
4. Press the required pre-set number button (once for preset memories 1 to 5 and twice for preset memory 6 to 10) press and release the M button to store the station.
5. Repeat the above for the remaining pre-set memories.

*Note: if a station is not stored during the 8 seconds in which 'MEMORY' is flashing in the display, the memory store mode is cancelled. No changes to the memory pre-sets will be made.*

### Recalling a station from memory

1. To recall to a preset station, first select the waveband and then press the required preset button.
2. Press a pre-set number button once for preset memories 1 to 5 and twice for preset memories 6 to 10.

### RDS Functions (FM stations only)

The RDS (Radio Data System) is a system where inaudible digital information is transmitted in addition to the normal FM radio programme. The following features are implemented on the R979:-

#### **Programme Service (PS) Name**

Provides a station name display in not more than eight alphanumeric characters.

#### **Clock Time (CT)**

Provides automatic setting and synchronisation of the inbuilt clock.



#### **Alternate Frequencies (AF)**

Provides a list of and allows easy re-tuning to alternative frequencies for the station you are listening to.







### Traffic Information (TP)

Shows which programmes provide traffic announcements and is indicated by the  symbol in the display. Traffic Announcements are indicated by a flashing  symbol in the display.

### Enhanced Other Networks (EON)

Provides information about other stations on the network. When used in conjunction with the (TP/TA) function it allows the radio to re-tune to stations broadcasting traffic announcements.

### Operating the radio with RDS functions (FM only)

1. Switch on the radio and select the FM waveband.
2. Tune into a station, the display will indicate frequency for two seconds and then change to show the station name. The  symbol will appear in the display
3. If the station does not carry RDS information only the station frequency will be shown. Note: the  indicator will flash if the signal is too weak for RDS operation.

### Display Modes

Whilst tuned to an RDS station you can change between station name and normal time display by repeated pressing of the display button [13].

### Alternate Frequency (AF)

The RDS system provides you with a list of alternative frequencies for the station you are tuned to.

1. Switch on the radio and select the FM waveband.
2. Tune into a station carrying RDS information.
3. Repeatedly press the alternate frequency AF button [18] until the radio finds a frequency giving the best reception for the station you wish to listen to.



If AF information has not yet been received or is not provided by the station

you are listening to, the radio will remain at the current frequency and the display will indicate 'NO AF'

*Note: Some BBC stations have several different frequencies for each station.*

### Traffic Announcements

Switch on the radio select the FM waveband and tune to an RDS station. The  symbol will appear in the display.

Repeatedly press the traffic button [16]. If the station provides traffic information the  symbol will appear in the display. If the station does not provide traffic information the  symbol will not appear and the radio will beep indicating that no traffic information is available. During traffic announcements the  symbol will flash in the display. The volume setting during traffic announcements is pre-set and is unaffected by the volume control. This means that when tuned to a station giving traffic announcements the volume can be set to minimum so as to block out normal programs. During traffic announcements the volume will increase to a pre-set level allowing the user to listen to traffic announcements only.

If the station carries Enhanced Other Network information the **EON** symbol will appear in the display. The radio will automatically tune to other stations transmitting traffic information. When the traffic announcement has finished the radio will re-tune to the previously selected station.

e.g. If the radio is tuned to a national station such as BBC Radio 2, it will automatically re-tune to any BBC local station broadcasting traffic announcements. When the traffic announcement on the local station is finished the radio will re-tune to the previously selected station.

*Note:* There may be occasions when the station to which you are listening tells the radio to re-tune to a traffic announcement on a local station that is not receivable at your location. Under these circumstances there will be some hiss before the radio re-tunes back to the previously selected station.

To turn off traffic information press the traffic button, the  symbol will be removed from the display.





## Display backlight



Pressing any of the control buttons will cause the display backlight to be switched on for 8 seconds.

## Headphones (not included)

A 3.5mm dia headphone socket [1] is provided for use with either headphones or an earpiece. Inserting a plug into the headphone socket automatically mutes the internal loudspeaker.

## Troubleshooting

### Clock will not auto set

1. Ensure that the radio is tuned to an FM station transmitting RDS data and clock time (CT) e.g BBC Radios 1, 2, 3, or 4.
2. Repeatedly press the time button [11] until the auto set indicator  appears in the display.
3. Whilst the clock is setting the auto time set indicator  will flash in the display indicating that the radio is waiting for the RDS time signal. The  indicator will stop flashing when the time is set. If the clock does not set within three to four minutes the radio station may not be transmitting clock time (CT) information - try tuning to another radio station.

### RDS station name not displayed

1. Rotate the telescopic aerial until the  **RDS** symbol appears in the display after a few seconds the station name should appear in the display.
2. If this fails to cure the problem try moving the radio to a different location or re-tuning to another radio station.

### Display shows **LOCKED** when any button pressed

1. Pressing any of the control buttons with the safety lock switched on will cause the display to show **LOCKED**. Slide the lock switch [22] up to unlock the radio.

### Display shows station name for a few seconds before returning to clock time.

1. You can change between station name and normal time display by repeated pressing of the display button [13].

### Radio will only receive strong stations on FM

1. For normal operation set the sensitivity switch [5] to the 'dx' position.  
*Note : the sensitivity switch is operational on the FM band only.*

*If a problem persists our technical staff would be pleased to offer assistance on operating the radio. Our technical helpline number is, 0181 758 0338.*





## Specifications

### Power Requirements

Mains : 230 volts, 50Hz  only  
 Batteries : Radio 6.0V 4 x IEC LR14 (C size) cells  
 Clock 3.0V 2 x IEC LR6 (AA size) cells

### Battery Life

Approx. 40hrs of listening for 4 hours a day at normal volume, using Alkaline cells.

### Frequency Coverage

FM 87.5-108MHz  
 MW 531 - 1620kHz  
 LW 144 - 281kHz

## Circuit Features

Loudspeaker 100mm 4ohms  
 Output Power 1watt into 4ohms  
 Headphone socket 3.5mm dia  
 Aerial System FM Telescopic aerial  
 MW Built-in Ferrite aerial  
 LW Built-in Ferrite aerial

*The Company reserves the right to amend the specification without notice.*

Imported by:-  
 ROBERTSRADIO LIMITED  
 PO BOX 130  
 MEXBOROUGH  
 SOUTH YORKSHIRE  
 S64 8YT



## Guarantee

This instrument is guaranteed for twelve months from the date of delivery to the original owner against failure due to faulty workmanship or component breakdown, subject to the procedure stated below. Should any component or part fail during this guarantee period it will be repaired or replaced free of charge.

The guarantee does not cover:

1. Damage resulting from incorrect use.
2. Consequential damage.
3. Radios with removed or defaced serial numbers.

N.B. Damaged or broken telescopic aerials will not be replaced under guarantee.

Procedure:

Any claim under this guarantee should be made through the dealer from whom the instrument was purchased. It is likely that your Roberts dealer will be able to attend to any defect quickly and efficiently, but should it be necessary the dealer will return the instrument to the company's service department for attention. In the event that it is not possible to return the instrument to the Roberts dealer from whom it was purchased, please contact Roberts Radio service department at the address shown on the back page of this manual before taking further action.

*These statements do not affect the statutory rights of a consumer.*

### ROBERTS RADIO TECHNICAL SERVICES DEPARTMENT

97-99 WORTON ROAD  
ISLEWORTH MIDDLESEX  
TW7 6EG  
*Issue 1*

