

# ROBERTS

## Play M4 / Play M5

DAB / DAB+ / FM RDS portable digital radio with clock and alarms



**DAB**  
Digital Audio Broadcasting

**DAB+** **+** Digital  
Radio

Please read this manual before use

## Contents

<i>Controls Play M4 / Play M5</i> .....	2-3	<i>Cancelling alarms</i> .....	15
<i>Battery operation</i> .....	3	<i>Snooze timer and alarm duration</i> .....	16
<i>Navigation controls</i> .....	4	<i>Disabling alarms</i> .....	16
<i>Using the radio for the first time</i> .....	5	<i>Sleep timer</i> .....	17
<i>Operating your radio - DAB</i> .....	6	<i>Clock style</i> .....	17
<i>Selecting a station - DAB</i> .....	7	<i>Software version</i> .....	17
<i>Secondary services - DAB</i> .....	7	<i>Display backlight dimmer</i> .....	18
<i>Finding new stations - DAB</i> .....	7	<i>Language function</i> .....	18
<i>Manual tuning - DAB</i> .....	8	<i>Headphone socket</i> .....	19
<i>Dynamic range control - DAB</i> .....	8	<i>Auxiliary input socket</i> .....	19
<i>Station order - DAB</i> .....	8	<i>System reset</i> .....	20
<i>Prune stations - DAB</i> .....	9	<i>Electro-magnetic compatibility advice</i> .....	20
<i>Operating your radio - FM</i> .....	9	<i>Product markings</i> .....	20
<i>Manual tuning - FM</i> .....	10	<i>Safety advice</i> .....	21
<i>Scan sensitivity setting - FM</i> .....	10	<i>Specifications &amp; Circuit features</i> .....	22
<i>Stereo / Mono switching - FM</i> .....	10	<i>Guarantee</i> .....	Back page
<i>Display options - DAB / FM</i> .....	11		
<i>Presetting stations</i> .....	12		
<i>Automatically updating the clock</i> .....	13		
<i>Setting the clock format</i> .....	13		
<i>Setting the clock manually</i> .....	13		
<i>Setting the alarm clock</i> .....	14-15		

## Controls Play M4 / Play M5

### Front

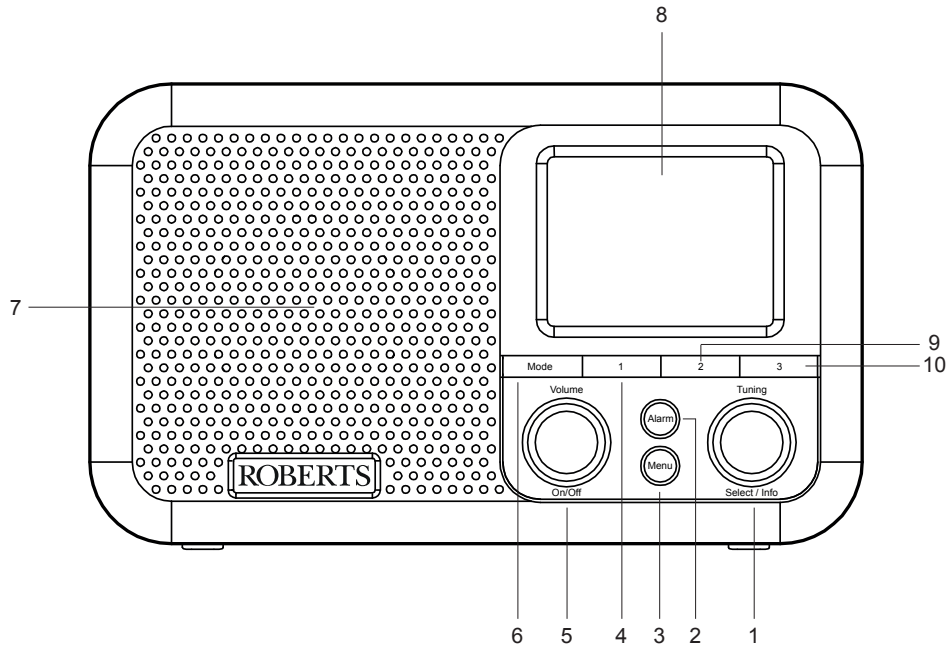

1. Tuning / Select / Info / Snooze control
2. Alarm button
3. Menu button
4. Preset 1 button
5. Volume / On / Off / Sleep control

6. Mode button
7. Loudspeaker
8. LCD display
9. Preset 2 button
10. Preset 3 button



## Controls Play M4 / Play M5

### Rear

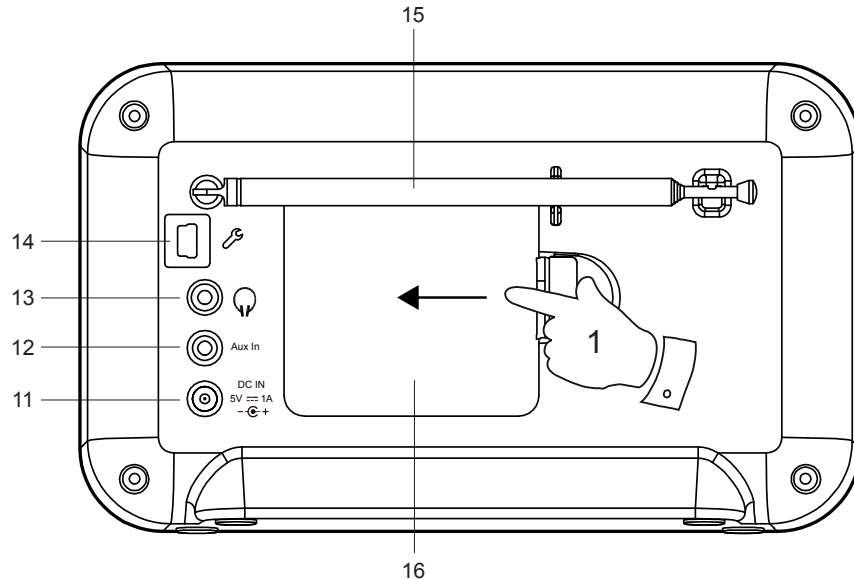
11. DC Input socket
12. Auxiliary Input socket
13. Headphone socket
14. USB socket (for service use only)
15. Telescopic aerial
16. Battery compartment



### Battery operation

1. Remove the battery cover located on the back of the unit by applying pressure to the catch in the direction shown by the arrow and then lifting off the cover.
2. Insert four LR6 (AA size) batteries into the spaces in the compartment. Take care to ensure all batteries are inserted with the correct polarity as shown inside the battery compartment. Replace the battery cover. Rechargeable batteries may be used but must be charged in an external battery charger.
3. The low battery indicator showing on the display , reduced power, distortion and a 'stuttering' sound are all signs that the batteries may need replacing. When the batteries have full charge the full battery indicator  will be shown on the display.
4. The alarm clock function may be used when the radio is powered from batteries (see page 14).
5. If the radio is not to be used for any extended period of time it is recommended that the batteries are removed from the radio.

*We would recommend for economy that the radio is used via the AC adaptor whenever possible with battery operation for occasional use only.*

**IMPORTANT:** The batteries should not be exposed to excessive heat such as sunshine, fire or the like. After use, disposable batteries should if possible be taken to a suitable recycling centre. On no account should batteries be disposed of by incineration.

**Caution:** Replace batteries only with the same or equivalent type. Danger of explosion if the batteries are incorrectly replaced.

## Navigation controls

This page describes the basic means of controlling your radio. Detailed instructions for each operating mode are given in the later sections of this book.

1. Pressing and releasing the **On/Off** control brings your radio out of the Standby mode if running from the mains or switches it on if using batteries.

Pressing and releasing the **On/Off** control while the radio is in use will cause it to return to the Standby mode with the clock display when running from the mains, or will switch it off after a short delay when running on batteries.

2. Pressing the **Mode** button gives you access to each of the operating modes in turn: DAB radio, FM radio and Auxiliary Input.

Alternatively, press the **Mode** button and then turn the **Tuning/Select** control clockwise or anti-clockwise to highlight the desired menu item then press the control to select that item.

3. Pressing the **Menu** button will access the menu system.

4. Many operations require the user to make a selection from the menu. This is done using the **Tuning/Select** control. Turn the control clockwise or anti-clockwise to highlight the desired menu item then press the control to select that item.

If there are more than six items in a menu, then the display will automatically scroll up or down so that the additional items become visible.

If there are many items in a menu, then the radio allows the menu to 'wrap around' in either direction. This can make it easier to reach items at the end of a long menu, such as a list of DAB radio stations.

5. If an error is made when navigating the menus, it is generally possible to go back to a higher level menu by pressing the **Menu** button.

6. The **Tuning/Select** control allows the display of information relating to the radio station.

**Note:** In this booklet press always means press and release. If it is required to give a long press on a button this is described as **apply a long press** and the button should be held down for 2 to 3 seconds until the radio has responded.

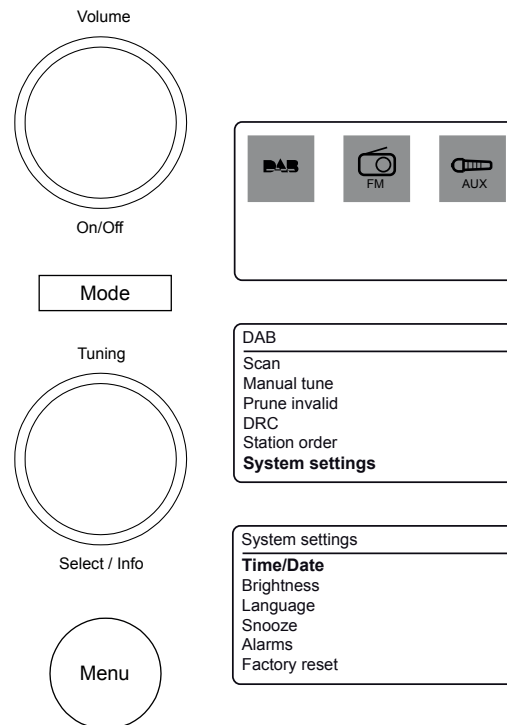

## Using the radio for the first time

1. Place your radio on a flat surface.
2. Carefully extend the telescopic aerial. The aerial should be fully extended and positioned vertically for optimum reception.
3. Plug the mains adaptor into the DC input socket located on the rear of your radio (marked 'DC In') ensuring that the plug is pushed fully into the socket.
4. Plug the other end of the mains adaptor into a standard mains socket outlet and switch on the wall socket.
5. The display on the radio will briefly show a start up screen. During this time the radio is scanning to find a DAB radio signal. After a short time the current time will appear on the display.
6. If no signal is found, it may be necessary to relocate your radio to a position giving better reception. You should then carry out a scan to find stations, see '*Finding new stations*' on page 7.

*The AC adaptor should be disconnected from the mains supply and from the radio when not in use.*

**IMPORTANT:** The mains adaptor is used as the means of connecting the product to the mains supply. The mains socket and any multi-way mains block used for the product must remain accessible during normal use. In order to disconnect the product from the mains, the mains adaptor should be removed from the mains socket completely.

Use only the mains adaptor provided with the product, or a genuine replacement provided by Roberts Radio. The use of alternative adaptors will invalidate the guarantee.

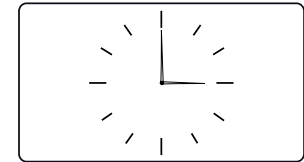
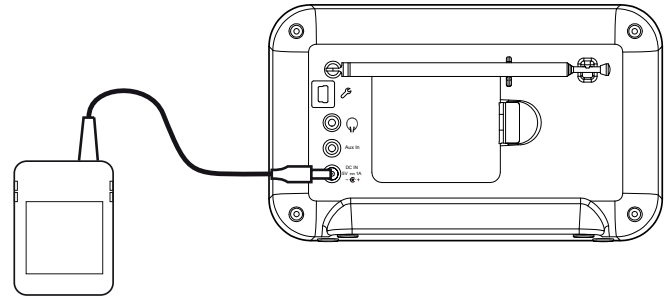

## Operating your radio - DAB

1. Press the **On/Off** control to switch on your radio.
  2. When first switched on, the radio will be in DAB mode. After each use the radio will remember the mode used and then switch on in that mode the next time it is used. If the radio has been used before, the last used station will be selected.
  3. If this is the first time the radio has been used a scan of the Band III DAB channels will be carried out (depending on whether scanning was already completed in standby mode). During the scanning process the display will show the progress of the station search. The number on the display is the number of stations that have been found.
  4. When the scan is completed the first station (in numeric-alpha order 0...9...A...Z) will be selected. The first station in the list of stations found during scanning will be highlighted. Rotate **Tuning** to step through the list of available stations. Press **Tuning** to select and tune to the desired station. The display will show the station name.
  5. If no signals are found then it may be necessary to relocate your radio to a position giving better reception. You should then carry out a scan to find new stations as described on page 7.
- Your radio has an indicator  on the display to indicate the strength of the DAB radio signal being received.

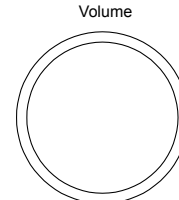

Volume

On/Off

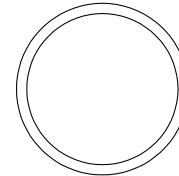

Tuning

Select / Info

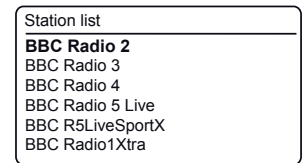
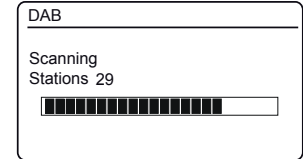

**Note:** When first switched on, the radio will set the volume to a moderately high level, in case the broadcast is very quiet. After you have set the volume, the radio will remember the setting that you have applied for the next time that it is used.

## Selecting a station - DAB

1. Press **On/Off** to switch on the radio.
2. Press **Mode** until the 'DAB' mode is selected.
3. Rotate **Tuning** to step through the list of available stations.
4. Press **Tuning** to select and tune to the desired station.
5. Adjust the **Volume**.

Alternatively to access the station list using the DAB menu, press the **Menu** button and then choose 'Station list'.

**Note:** If after selecting a station the station does not tune, it may be necessary to relocate your radio to a position giving better reception.

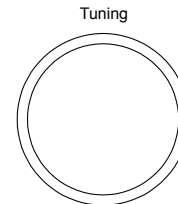
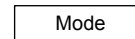
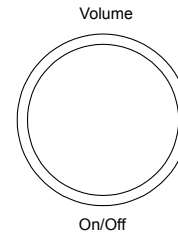

Select / Info

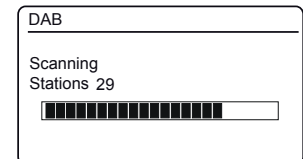
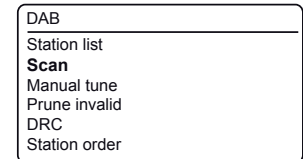
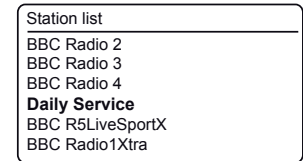
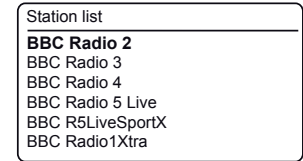
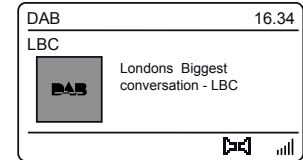
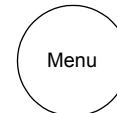

## Secondary services - DAB

Some radio stations may have one or more additional broadcasts associated with them. If these are available, they will appear immediately after the main station as you rotate the **Tuning** control clockwise. To tune to the selected service, press **Tuning**.

## Finding new stations - DAB

As time passes new stations may become available or you may have moved your radio to a different part of the country. In this case you may need to cause your radio to scan for new stations.

1. Press **On/Off** to switch on the radio.
2. Press **Mode** until the 'DAB' mode is selected.
3. Press **Menu**.
4. Choose 'Scan'.
5. Press **Tuning**. Your radio will perform a scan of the Band III DAB channels. As new radio stations are found the station counter on the display will increase and the radio stations will be added to the list stored in the radio.



## Manual tuning - DAB

Manual tuning allows you to tune your radio to a particular DAB frequency in Band III. Any new stations found will be added to the station list. This function can also be used to assist the positioning of the telescopic aerial or the radio to optimise reception for a specific channel or frequency.

1. When in DAB mode, press **Menu**.
2. Choose 'Manual tune' and then select the desired DAB channel.
3. Press **Tuning** to tune to the chosen frequency. When the radio has tuned, the display shows the channel number, frequency, and the name of the DAB multiplex found (if any). A bar graph shows the signal strength and is useful if you need to reposition the radio or its telescopic aerial. The minimum signal marker 'I' which separates the left and right parts of the signal graph shows the minimum signal level required for satisfactory reception. Any new radio stations found on the tuned DAB multiplex will be added to the list stored in the radio.
4. Press **Menu** to choose a different frequency or return to the normal playing mode.

## Dynamic Range Control (DRC) settings - DAB

The DRC facility can make quieter sounds easier to hear when your radio is used in a noisy environment.

1. When in DAB mode, press **Menu**.
2. Choose 'DRC' and then choose the required DRC setting (default is Off).  
DRC Off - DRC is switched off, Broadcast DRC will be ignored. DRC Low - DRC level is set to 1/2 that sent by broadcaster. DRC High - DRC is set as sent by broadcaster.
3. Press **Tuning** to confirm the setting. **Note:** Not all DAB broadcasts use the DRC function. If the broadcast does not provide DRC information, then the DRC setting in the radio will have no effect.

## Station order - DAB

Your radio has 3 station order settings from which you can choose. The station order settings are alphanumeric, ensemble and valid (default is alphanumeric).

1. When in DAB mode, press **Menu**.
2. Choose 'Station order' and then choose the required station order setting. Press **Tuning**.  
Alphanumeric - sorts alphabetically, Ensemble - sorts by multiplex, Valid shows only stations with a signal.

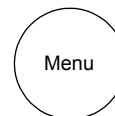

Tuning

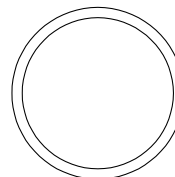

Select / Info

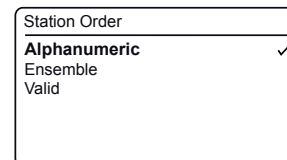
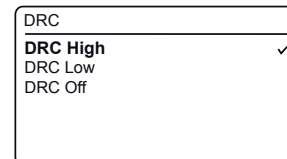
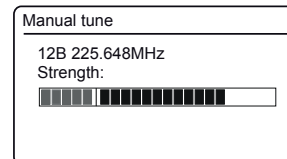
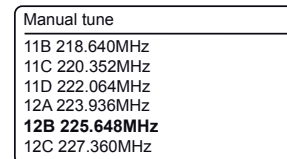
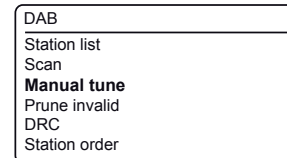

## Prune stations - DAB

If you move to a different part of the country, some of the stations which were listed may no longer be available. Also, from time to time, some DAB services may stop broadcasting, or may change location or frequency. Stations which cannot be found, or which have not been received for a very long time are shown in the station list with a question mark.

The Prune stations function will delete the marked DAB stations from your station list.

1. When in DAB mode, press **Menu**.
2. Choose *'Prune invalid'* and then choose *'Yes'* to cause the invalid station names to be removed from the station list.
3. If you do not wish to prune stations choose *'No'* in step 2 above.

**Note:** If you have moved your radio to a different part of the country you should also carry out a search for new stations (please see the section *'Finding new stations'* on page 7).

## Operating your radio - FM

1. Carefully extend the telescopic aerial. Press **On/Off** to switch on the radio.
2. Press **Mode** until the *'FM'* mode is selected.
3. Rotate the **Tuning** control clockwise. The displayed frequency will increase.  
**Apply a long press** on the **Tuning** control to carry out an auto-tune. Your radio will scan in an upwards direction (low frequency to high frequency) and stop automatically when it finds a station of sufficient strength.
4. The display will show the frequency of the signal which has been found. If RDS information is available, after a few seconds the display will show the radio station name. If you only hear hiss or interference, simply **apply a long press** on the control to scan further.
5. To scan down in frequency, rotate the **Tuning** control anti-clockwise and then **apply a long press** on the control. Your radio will scan the FM band in a downwards direction (high frequency to low frequency).
6. When the waveband end is reached your radio will recommence tuning from the opposite waveband end. Adjust the **Volume**.
7. To switch off your radio press **On/Off**.

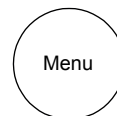

Tuning

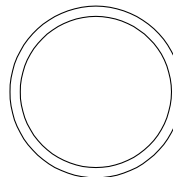

Select / Info

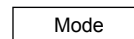

Tuning

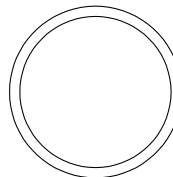

Select / Info

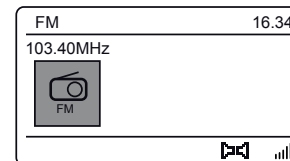
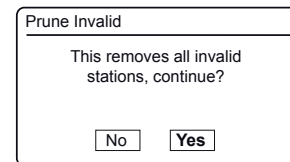
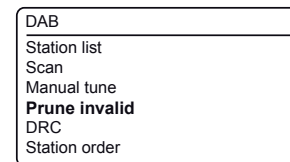

## Manual tuning - FM

1. Rotate the **Tuning** control to tune to a station. The frequency will change in steps of 50kHz. Adjust the **Volume**.

## Scan sensitivity setting - FM

Your radio will normally scan for FM broadcasts which are strong enough to give good reception. However, you may wish the Auto-scan function to also be able to find weaker signals, possibly from more distant radio transmitters. Your radio includes a local / distant option for the Auto-scan function.

1. When in FM mode, press **Menu**.
2. Choose 'Scan setting'.
3. To set your radio so that only the stations with the strongest signals are found during scanning choose 'Yes'. (Normally this will restrict scanning to local transmissions).
4. Alternatively, to set your radio so that all available stations are found during scanning (local and distant transmissions) choose 'No'.

**Note:** The initial setting (out of the box, or after a System Reset) causes the radio to ignore weaker (or more distant) signals.

## Stereo / Mono switching - FM (headphones only)

Your radio will play stereo FM broadcasts in stereo (via headphones only) provided that the received signal is of adequate strength. However, as a stereo signal becomes weaker the audio signal will become poorer. It may be preferable to force the radio to play the station in mono in order to reduce the level of background hiss.

1. Ensure your radio is in FM mode and tune to the required FM station.
2. To change the audio setting, press **Menu**.
3. Choose 'Audio setting'. The current audio setting is indicated with a tick. To switch to mono in order to reduce the hiss from a weak FM signal choose 'Mono' or choose 'Stereo' to return to the normal automatic 'stereo or mono' setting.

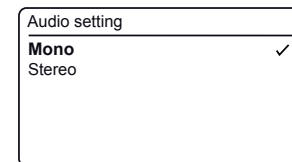
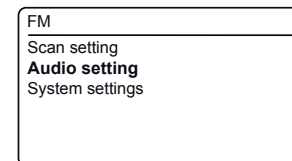
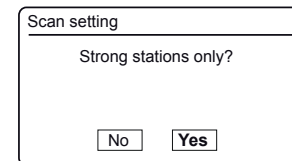
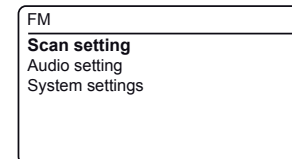
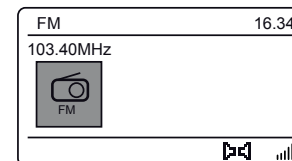
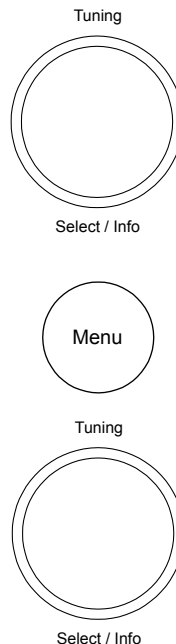

## Display options - DAB / FM

Your radio has a range of display options when in DAB or FM modes:-

1. Press the **Tuning / Info** control to cycle through the various options.

### DAB display options

Your radio can display the following in DAB mode:-

Station name, scrolling text, program type, multiplex name, channel & frequency, signal strength / error rate, bit rate, audio type and date.

For the signal strength/error rate a low error number indicates a better quality of DAB radio signal. The minimum signal marker 'I' which separates the left and right parts of the signal graph shows the minimum signal level required for satisfactory reception.

### FM display options

In FM mode your radio can use the Radio Data System (RDS) to display the radio station name and additional text when provided by the broadcaster and where the radio signal is sufficiently clear.

Your radio can display the following in FM mode:-

Station name, scrolling text, frequency, program type and date.

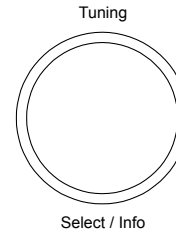

### Scrolling text (DAB and FM)

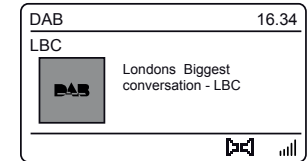

### Signal strength (DAB only)

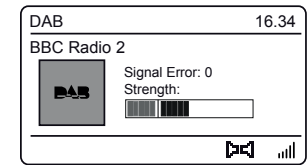

### Frequency (DAB and FM)

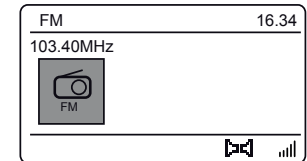

### Date (DAB and FM)

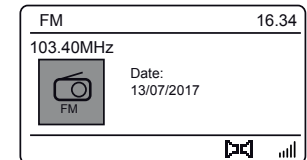

## Presetting stations in DAB and FM modes

You may store your preferred DAB and FM radio stations to the preset station memories. There are 6 memory presets in your radio, 3 for DAB and 3 for FM. Presets are remembered by your radio in the event of a power failure.

The procedure for setting presets and using them to tune stations is the same for FM and DAB modes and is described below.

### Storing a preset using the preset buttons 1 - 3

1. Press **On/Off** to switch on your radio.
2. Tune to the required DAB or FM radio station as previously described.
3. To store the currently playing radio station as a preset, **apply a long press** on the required **Preset** button (1-3). The station will be stored using the chosen preset button. The preset number is shown at the bottom of the display screen. Repeat this procedure as needed for the remaining presets.
4. Stations that are already stored in the presets may be over-written by following the procedure described above.

**Note:** The radio station presets are retained in memory when the radio is switched off and disconnected from the mains supply.

### Recalling a preset using the preset buttons 1 - 3

1. Press **On/Off** to switch on your radio.
2. Select either the DAB or FM mode using the **Mode** button.
3. Momentarily press the required **Preset** button (1-3). Your radio will then tune to the station stored in the selected preset memory.
4. The preset used will be shown at the bottom of the display screen.

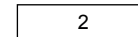
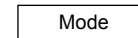
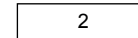
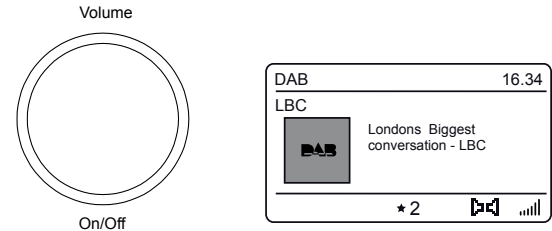

# Clock and Alarms

## Automatically updating the clock

Your radio will usually set the clock time using the DAB signal. You may specify that the radio sets its clock using signals from the DAB or FM waveband or none. If you choose none you will need to set the clock manually.

1. With your radio switched on, press **Menu**.
2. Choose '*System settings*', '*Time/Date*', '*Auto Update*' and then choose an update option from '*Update from DAB*', '*Update from FM*' or '*No Update*' as required.

If a signal is not found you should then either position the radio or its aerial so that a signal can be received, or revert to manual clock mode below.

## Setting the clock format

The clock display used in Standby mode and on the playing mode screens can be set to 12 or 24 hour format. The selected format is then also used when setting the alarms.

1. With your radio switched on, press **Menu**.
2. Choose '*System settings*', '*Time/Date*', '*Set Format*' and then select 12 or 24 hour. The current clock display format is marked with a tick.

If the 12 hour clock format is chosen, the radio will then use the 12 hour clock for the setting of alarms, and will display a 12 hour clock with an AM or PM indicator when in Standby mode.

## Setting the clock manually

Normally your radio will set its clock automatically using the DAB radio signal. If no DAB signal is available and you need to set the time manually, please follow the procedure shown below.

1. With your radio switched on, press **Menu**.
2. Choose '*System settings*', '*Time/Date*', '*Set Time/Date*' and then select the desired day, month, year, hour and minute setting.
3. Press **Tuning** to confirm the time setting.

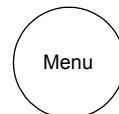

Tuning

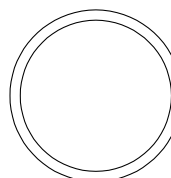

Select / Info

System settings
<b>Time/Date</b>
Brightness
Language
Snooze
Alarms
Factory reset

Auto Update
<b>Update from DAB</b> ✓
Update from FM
No Update

Set Format
12
<b>24</b> ✓

Time/Date
<b>Set Time/Date</b>
Set Format
Auto Update
Clock Style

Set Time/Date
<b>31-05-2017</b>
16:04

## Setting the alarm clock

Your radio has two alarms which can be set to wake you to DAB, FM radio or buzzer alarm. Each alarm can be set to sound once, daily, on weekdays or at weekends. In the event of a power interruption your radio has a built in memory that will retain your alarm settings. Ensure that the time is set correctly before setting the alarms.

Alarms can be set while the radio is in Standby mode or switched on. You may set the alarm duration to sound for 30, 60, 90 or 120 minutes. Please see 'To set the alarm duration' page 16.

Alarms may be used whether the radio is powered from the mains or from batteries. If the radio is switched off when powered from batteries, the clock will continue to run so that alarms can be used. However the clock display will be switched off to extend battery life.

You may use the **Tuning** control to select or modify any particular setting using the control to enter the modification. If no buttons are pressed for 10 seconds, your radio will exit the alarm setup.

1. To change the On / Off states of the alarms while the radio is in Standby or switched on, press the **Alarm** button. The display will cycle through No Alarm, Alarm 1 enabled, Alarm 2 enabled or Alarms 1 and 2 enabled.
2. To change the detailed alarm settings while the radio is in Standby or switched on, **apply a long press** on the **Alarm** button. This will cause the Alarms menu to be displayed.
3. Choose either 'Alarm 1' or 'Alarm 2'.
4. Choose 'Alarm Time' to adjust the alarm time.
5. Choose the alarm hour and then the minute. The display will then return to the alarm setting menu.
6. Choose 'Alarm Mode'. The display will show the alarm mode options. The alarm mode options are as follows:

'Off' - the alarm will be disabled

'Daily' - the alarm will sound everyday

'Once' - the alarm will sound once

'Weekdays' - the alarm will sound on weekdays only

'Weekends' - the alarm will sound only at weekends

Choose the required alarm mode option. Choosing Off will disable the alarm.

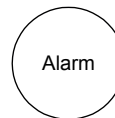

Tuning

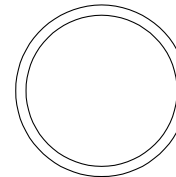

Select / Info

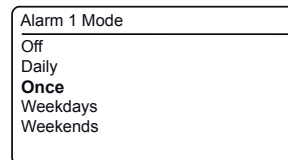
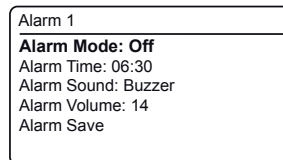
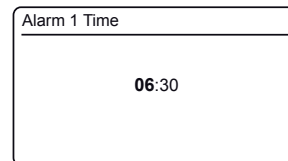
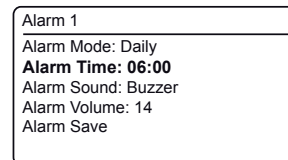
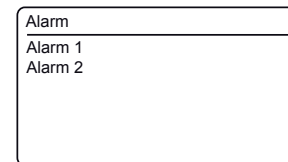

## Setting the alarm clock - cont.



- The alarm can be set to buzzer, DAB radio or FM radio. For whichever radio mode is selected, the radio alarm may be set to any of the stations which have been stored as presets or to the station most recently listened to.

Choose the '*Alarm Sound*' option for the alarm then select either '*Buzzer*' or the required radio mode.

- If setting the alarm to the radio option, choose the '*Preset*' option then choose either the radio station '*Last Listened*' to, or from presets 1- 3.

**Note:** You can only set the alarm to use a preset which has already been stored.

- Choose the '*Volume*' option. The radio uses the saved volume setting for each alarm when it sounds. Use the **Tuning** control to set the required volume.
- In order to store the alarm settings rotate **Tuning** until '*Alarm Save*' is highlighted. Press **Tuning** to store the alarm settings. Your radio will show '*Alarm Saved*'.

Active alarms are shown using small alarm indicators   and the corresponding alarm number at the bottom of the playing displays and on the clock display when in Standby.

**Note:** If you make a mistake at any point while setting the alarms, it is generally possible to go back to the previous screen using the **Menu** button.

## When the alarm sounds

The alarm will sound at the selected times for up to 120 minutes unless cancelled. The volume used for the alarm will be specified during the alarm setting procedure. When your radio is set to wake by the radio alarm, your radio will switch to the selected radio station. If the radio cannot receive the specified DAB radio station, the buzzer will be used instead. **Note:** If the radio is switched on because of a radio alarm you can control basic functions such as the volume control.

When the alarm activates it will start softly and gradually increase in level. The alarm icon will flash on the screen and the radio will automatically switch back to standby mode when the selected alarm duration has elapsed.

## Cancelling alarms

- Whilst an alarm is sounding, press **On/Off** to cancel the alarm.
- If the snooze feature is not required, then setting the snooze option to '*OFF*' will allow other controls also to be used to cancel an alarm (see page 16).

Tuning

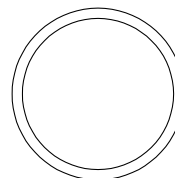

Select / Info

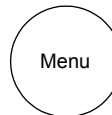

Menu

Volume

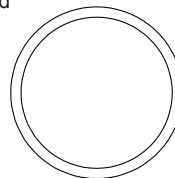

On/Off

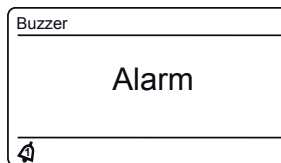
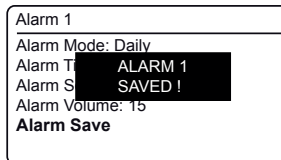
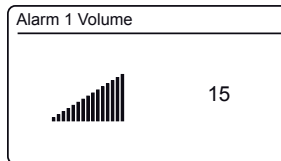
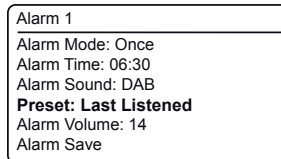
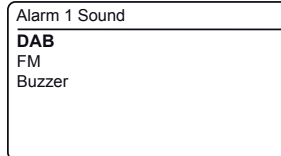



## Snooze timer

1. The snooze timer can be used to silence the alarm for 5, 10, 15 or 20 minutes before it will sound again. When the alarm sounds the snooze timer is activated by pressing the **Tuning/Select/Snooze** control or any of the buttons.
2. While the snooze timer is active, the alarm icon will flash on the clock display. When the alarm sounds again, the snooze function can be repeated as required.
3. In order to cancel the snooze timer while the alarm is suspended, press and release the **On/Off** control.
4. If the snooze timer option is set to 'OFF', then pressing the **Tuning / Select/Snooze** control or any of the buttons will cancel the alarm immediately.

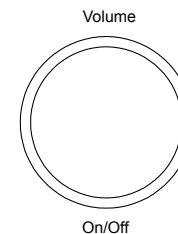
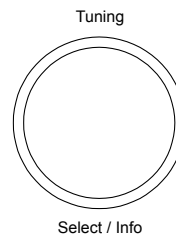

## To set snooze time

The snooze duration can only be set while the radio is playing.

1. With your radio switched on, press **Menu**.
2. Choose 'System settings' and then 'Snooze'.
3. Choose 5, 10, 15, 20 or to Off.

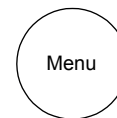

Tuning

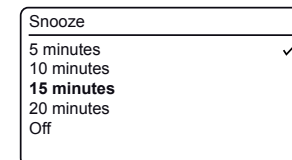
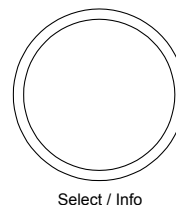

## To set the alarm duration

The alarm duration is adjustable and can only be set while the radio is playing (default duration is 30 minutes).

1. With your radio switched on, press **Menu**.
2. Choose 'System settings' and then 'Alarms'.
3. Choose 30, 60, 90, or 120 minutes.

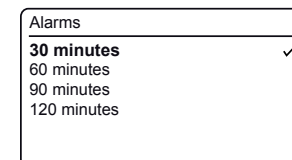

## Disabling alarms

1. To disable an alarm while the radio is in Standby or switched on, press the **Alarm** button to cycle through the alarm on-off options (see page 14, step 1).
2. Alternatively, to disable an alarm enter the alarm setup menu (see page 14 step 2 and 3) and choose 'Alarm Mode' option.
3. Select 'Off' mode option and 'Alarm Save'. The chosen alarm will now be disabled.

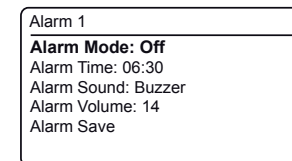
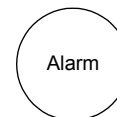

## Sleep timer

Your radio can be set to turn off after a preset time has elapsed. The sleep timer setting can be adjusted between 5 and 120 minutes in 5 minute increments.

1. Press **On/Off** to switch on your radio.
2. **Apply a long press** on the **On/Off** control to access the sleep timer. Select the required sleep time. The sleep timer can be set to between 5 and 120 minutes, or to Off which will cancel the sleep function. Press **Tuning** to confirm your desired sleep time.
3. An active sleep timer will be shown using a small timer indicator at the bottom of the playing displays. Your radio will switch off after the preset sleep time has elapsed.
4. To cancel the sleep time before the preset time has elapsed and to turn off the radio, press **On/Off** to turn the unit off manually.  
To cancel the sleep timer and leave the radio playing, go back into the sleep timer settings (steps 1 to 2 above) and select the Off option in step 2.

## Clock style

Your radio's standby display can be set to the analogue or digital clock style.

1. With your radio switched on, press **Menu**.
2. Choose 'System settings', 'Time/Date' and then 'Clock Style'.
3. To select the digital clock style choose 'Yes' or to select the analogue clock style choose 'No'. The current style will become visible when the radio is put into standby.

## Software version

The software version display cannot be altered and is just for your reference.

1. Press **On/Off** to switch on the radio.
2. Press **Menu**.
3. Choose 'System settings' and then 'Info'. The software version will be displayed. Press **Menu** as needed to exit.

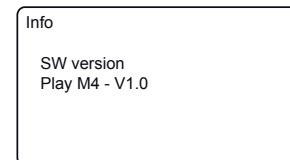
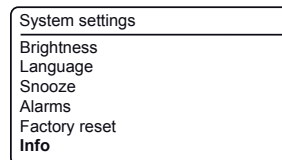
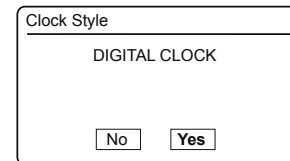
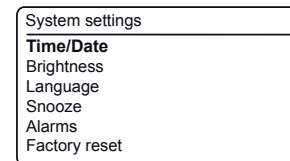
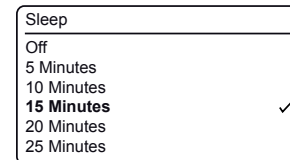
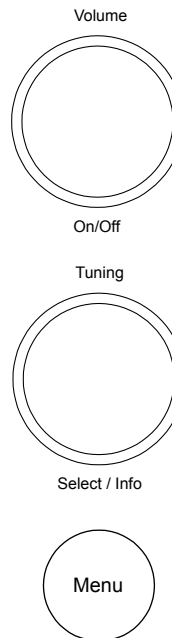

## Display backlight dimmer

The brightness of the display can be adjusted for when the radio is in standby or when in use. If you use the unit in the bedroom, you may prefer a lower standby brightness level than the standard setting. There are six standby brightness levels and six levels for when the radio is in use.

To change the current brightness setting please follow these steps with the radio switched on.

1. Press **Menu**.
2. Choose 'System settings' and then 'Brightness'.
3. To adjust the display brightness when the radio is switched on select 'Normal'.  
To adjust the display brightness when the radio is in Standby select 'Standby'.  
Press **Tuning** to enter the selected brightness adjustment mode.
4. Choose the High, Medium High, Medium, Medium Low, Low or Off dimmer setting.  
Note that the backlight is almost completely off at the Off setting.
5. Press **Tuning** to set the level. Press **Menu** as needed to exit.

When the radio is in standby and powered from the mains pressing any button or the rotary controls will cause the radio to switch to the 'High' brightness level for a few seconds. This is so that if the standby brightness level is set to Low or Off, it is still possible to see the time when needed.

## Language function

Your radio's menus can be configured to a different language.

1. Press **On/Off** to switch on your radio.
2. Press **Menu**. Choose 'System settings' and then 'Language'. The current language is indicated with a tick.
3. Choose your desired language. The display will change to the chosen language.
4. Press **Menu** as needed to exit.

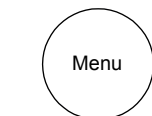

Tuning

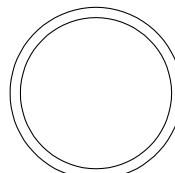

Select / Info

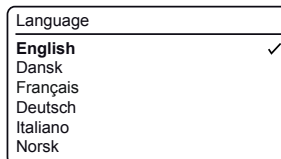
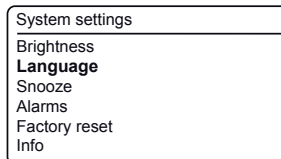
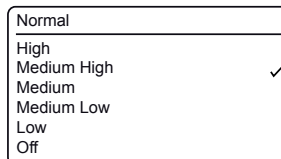
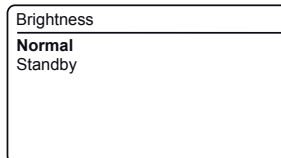
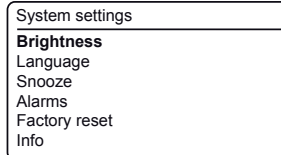

## Headphone socket

A 3.5mm **Headphone Socket** located on the rear of your radio is provided for use with either headphones or an earpiece. Inserting a plug automatically mutes the internal loudspeaker. Please be aware that the sensitivity of headphones can vary widely. We therefore recommend setting the volume to a low level before connecting headphones to the radio.

**IMPORTANT:** Excessive sound pressure from earphones and headphones can cause hearing loss.



To prevent possible hearing damage, do not listen at high volume levels for long periods.

## Auxiliary input socket

1. Connect a stereo or mono audio source (i.e. CD player, MP3 player, etc.) to the **Auxiliary input** socket.
2. Press **On/Off** to switch on the radio.
3. Press **Mode** until the display shows 'Aux In'.
4. Adjust the **Volume** control on your player and on the radio for comfortable listening.
5. Remove the cable from the **Auxiliary input** socket or press **Mode** to cancel Auxiliary Input mode.

Note that audio played via the auxiliary input will be played in mono through the speaker and in stereo through stereo headphones.

**Note:** If the radio is in Auxiliary input mode with no input signal being applied for more than 15 minutes then it will automatically switch to the standby mode. The LCD will revert to the standby mode clock display. To use the radio again, simply press the On/Off control to switch it on.

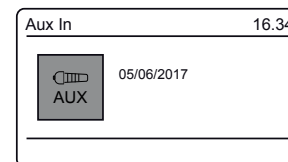
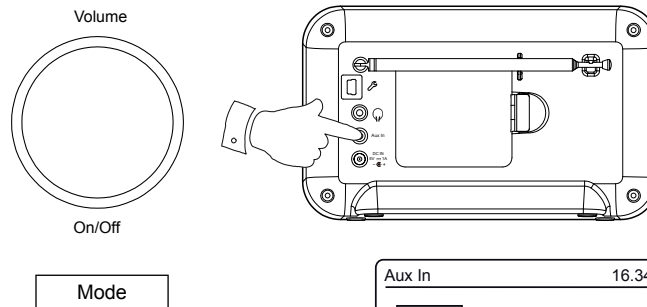
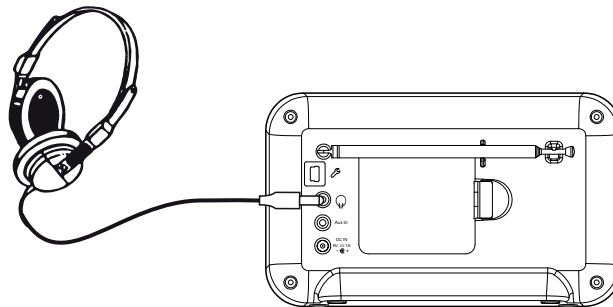

## System reset

If your radio fails to operate correctly, or some digits on the display are missing or incomplete carry out the following procedure.

1. Press **On/Off** to switch on the radio. Press **Menu**.
2. Choose 'System settings' and then 'Factory reset'.
3. Select 'Yes'. If you do not wish to carry out a system reset, select 'No'. The display will revert to the previous display.
4. With 'Yes' selected, press **Tuning**. A full reset will be performed. The station list and presets will be erased. Alarms will be cancelled and settings will be set to their default values. The display will show 'Resetting' and then after a few seconds a station scan search will be performed automatically. The radio will then restart as when first plugged in (see also page 6).

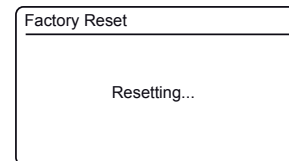
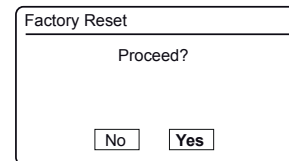
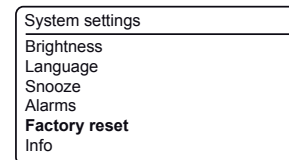
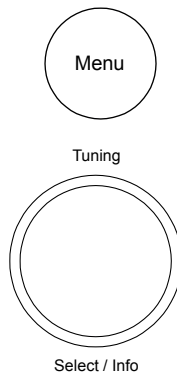

## Electro-magnetic compatibility advice

In the event of a malfunction due to electrostatic discharge, mains power supply transients or short interruptions, reset the product as above to resume normal operation. If you are not able to perform the reset operation as above, removal and reconnection of the power supply and batteries may be required.

If the product is used in an environment with any ESD Immunity / Radiated Immunity / Conducted Immunity disturbance, the product may malfunction. It will automatically recover to normal when the ESD Immunity / Radiated Immunity / Conducted Immunity disturbance is stopped.

## Product markings

	<b>DC Voltage</b> 5V / 1A
	<b>Recycling</b> This product bears the selective sorting symbol for Waste Electrical and Electronic Equipment (WEEE). This means that this product must be handled pursuant to European directive 2012/19/EU in order to be recycled or dismantled to minimize its impact on the environment. The user has the choice to give the product to a competent recycling organization or to the retailer when buying a new electrical or electronic equipment.

## Safety advice

Do not allow this radio to be exposed to water, steam or sand. Do not leave your radio where excessive heat could cause damage such as in a parked car where the heat from the sun can build up even though the outside temperature may not seem too high. It is recommended that the DAB band be used wherever possible as better results in terms of quality and freedom from interference will usually be obtained than on the FM band.



The name plate is located underneath the radio.

- Your radio and AC/DC adaptor should not be exposed to dripping or splashing and no objects filled with liquids, such as vases, shall be placed on the radio or adaptor.
- It is recommended to operate the product such that there is a minimum distance (10cm recommended) to adjacent objects in order to ensure good ventilation.
- The ventilation of the product should not be restricted by covering it or its ventilation openings with items such as newspapers, tablecloths, curtains etc.
- No naked flame sources such as lighted candles should be placed on the product.
- It is recommended to avoid using or storing the product at extremes of temperature. Avoid leaving the unit in cars, on window sills, in direct sunlight etc.
- There are no user serviceable parts inside this product.
- Do not attempt to disassemble any part of the product.
- The product must be used in a moderate climate.

## Specifications

### Power Requirements

Mains	AC 100 ~ 240volts, 50/60Hz (adaptor) (Use only the supplied adaptor)
Batteries	4 x LR6 (AA size) not included
Battery Life	Up to 25 hours using alkaline cells depending upon volume, display brightness and operating mode.

### Frequency Coverage

FM	87.5-108MHz
DAB	174.928 - 239.200MHz

## Circuit Features

Headphone socket (stereo)	3.5mm dia.
Auxiliary input socket (stereo)	3.5mm dia.
Aerial System	FM / DAB telescopic aerial

*The Company reserves the right to amend the specification without notice*

## Guarantee

This product is guaranteed for twenty four months from the date of purchase by the original owner against failure due to faulty workmanship or component breakdown, subject to the procedure stated below. Should any component or part fail during this guarantee period it will be repaired or replaced free of charge.

The guarantee does not cover:

1. Damage resulting from incorrect use.
2. Consequential damage.
3. Product with removed or defaced serial numbers.

N.B. Damaged or broken telescopic aerials will not be replaced under guarantee.

Procedure:

Any claim under this guarantee should be made through the dealer from whom the product was purchased. It is likely that your Roberts dealer will be able to attend to any defect quickly and efficiently, but should it be necessary the dealer will return the product to the company's service department for attention. In the event that it is not possible to return the product to the Roberts dealer from whom it was purchased, please contact Roberts Radio using the contact details on the [www.robertsradio.com](http://www.robertsradio.com) website.

For product repairs falling outside the guarantee period, please refer to the "customer care" tab on the [www.robertsradio.com](http://www.robertsradio.com) website.

*These statements do not affect the statutory rights of a consumer.*

## ROBERTS RADIO LIMITED

PO Box 130  
Mexborough  
South Yorkshire  
S64 8YT

Website: <http://www.robertsradio.com>

