

ROBERTS

Play

DAB / DAB+ / FM RDS digital radio with built-in battery charger



DAB
Digital Audio Broadcasting

DAB+

+ Digital
Radio

Please read this manual before use

Contents

<i>Controls</i>	2-3	<i>Software version</i>	20
<i>Battery operation</i>	4-5	<i>Language function</i>	20
<i>Using the AC adaptor</i>	6	<i>System reset</i>	21
<i>Lock switch</i>	6	<i>Headphone socket</i>	22
<i>Operating your radio - DAB</i>	7	<i>Display backlight</i>	22
<i>Selecting a station - DAB</i>	8	<i>USB socket for software upgrade</i>	22
<i>Secondary services - DAB</i>	8	<i>Battery information</i>	23-24
<i>Display options - DAB</i>	9	<i>General</i>	25
<i>Finding new stations - DAB</i>	10	<i>Specifications</i>	25
<i>Autoselect - DAB</i>	10	<i>Circuit features</i>	25
<i>Manual tuning - DAB</i>	11	<i>Guarantee</i>	26
<i>Dynamic range control - DAB</i>	12		
<i>Prune stations - DAB</i>	13		
<i>Operating your radio - FM</i>	14		
<i>Manual tuning - FM</i>	15		
<i>Display options - FM</i>	16		
<i>Stereo / Mono setting - FM</i>	17		
<i>Scan sensitivity setting - FM</i>	18		
<i>Presetting stations - DAB and FM</i>	19		
<i>Recalling a preset - DAB and FM</i>	19		

Controls

(Front)

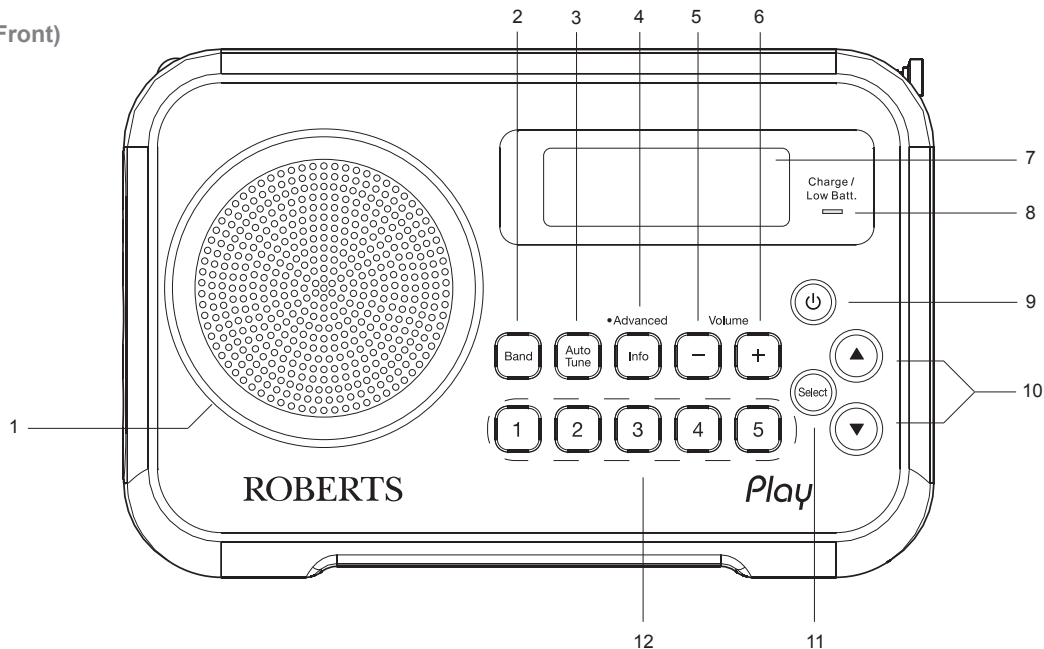

1. Speaker

2. Band button

3. Auto Tune button

4. Info button

5. Volume Down button

6. Volume Up button

7. LCD display

8. Charge / Low battery indicator

9. On / Off button

10. Tuning Up / Down buttons

11. Select button

12. Preset buttons

Controls
(Back)

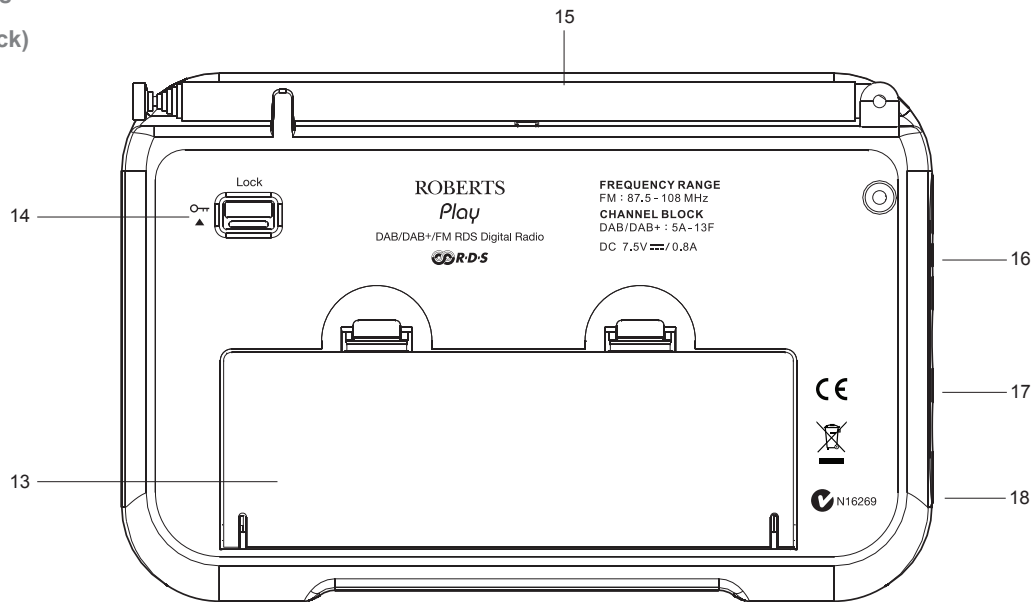

13. Battery compartment

14. Lock switch

15. Telescopic aerial

16. USB socket (for software upgrades)

17. Headphone socket

18. DC jack socket

Battery operation using alkaline batteries (also see page 23)

1. Remove the battery cover on the back of the unit by pushing the catches in the direction shown.
2. Slide the switch inside the battery compartment to the **Alkaline** position.
3. Insert four LR6 (AA size) alkaline batteries into the spaces in the compartment. Take care to ensure all batteries are inserted with the correct polarity as shown inside the battery compartment. Then replace the battery cover.

- **Important: when using alkaline batteries the battery switch must be placed in the alkaline position. Failure to do so could result in serious damage to the batteries or radio.**
- When the batteries are exhausted, the battery light will show red for a short while. The radio will then switch itself off. It may not be possible to switch the radio back on until the batteries are replaced, or until the radio is connected to the mains adaptor.
- If the radio is not to be used for any extended period of time it is recommended that the batteries are removed from the radio.
- *We would recommend for economy that the Play is used via the AC adaptor whenever possible with battery operation for occasional or stand-by use only. If extended listening using batteries is anticipated, then the use of rechargeable batteries is recommended.*

IMPORTANT: The batteries should not be exposed to excessive heat such as sunshine, fire or the like. After use, disposable batteries should if possible be taken to a suitable recycling centre. On no account should batteries be disposed of by incineration.

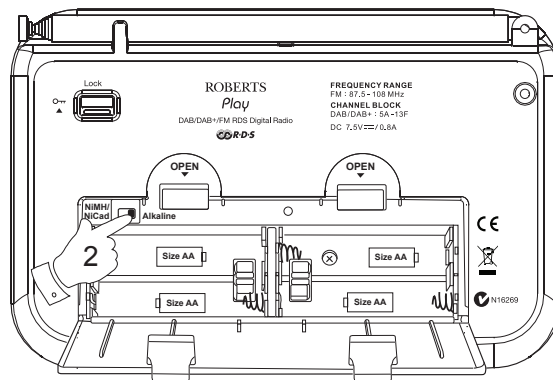

Battery operation using rechargeable batteries (also see page 23)

1. Remove the battery cover on the back of the unit by pushing the catches in the direction shown.
2. Slide the switch inside the battery compartment to the **NiMH** position.
3. Insert four identical Rechargeable LR6 (AA size) batteries into the spaces in the compartment. Take care to ensure all batteries are inserted with the correct polarity as shown inside the battery compartment. The radio is designed to be used with Nickel Metal Hydride (NiMH) rechargeable batteries.
4. Plug the mains adaptor into your radio and then plug the adaptor into the mains.
5. The battery light will flash green indicating batteries are charging. Batteries will be fully charged in around 7 hours. The battery light shows a steady green light when the battery charging is complete.
6. Under some conditions the charging indicator may switch off after flashing only briefly. This may happen if the batteries are already freshly charged, or if the radio detects that you may be attempting to recharge alkaline batteries. In these cases the charging will be stopped.

Note: You should never attempt deliberately to recharge alkaline batteries in the radio. Attempted recharging of alkaline batteries can be dangerous.

- **Important: when using rechargeable batteries the battery switch must be placed in the NiMH position. Batteries will only be charged when the radio is switched off and connected to the AC adaptor.**
- When the batteries are exhausted, the battery light will show red for a short while. The radio will then switch itself off. It may not be possible to switch the radio back on until the batteries are recharged, or until the radio is connected to the mains adaptor.

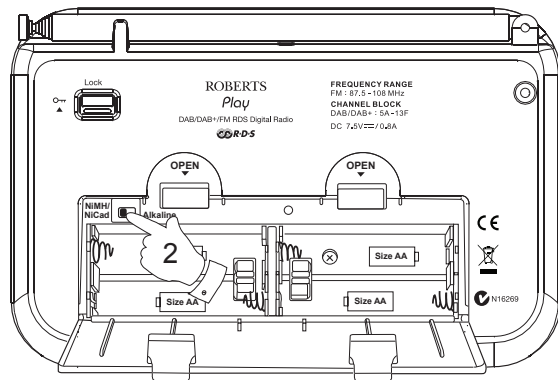

- If the radio is not to be used for any extended period of time it is recommended that the batteries are removed from the radio.

IMPORTANT: The batteries should not be exposed to excessive heat such as sunshine, fire or the like. After use, disposable batteries should if possible be taken to a suitable recycling centre. On no account should batteries be disposed of by incineration.

Using the AC adaptor

Your radio is supplied with a Mains Adaptor.

1. Place your radio on a flat surface.
2. Insert the adaptor plug into the DC socket located on the left hand side of your radio.
3. Plug the adaptor into a standard 13 amp mains socket outlet. Whenever the adaptor is used with the radio, it will take power from the mains rather than from the batteries.

The AC adaptor should be disconnected from the mains supply and the radio when not in use.

- **IMPORTANT:** The mains adaptor is used as the means of connecting the radio to the mains supply. The mains socket used for the radio must remain accessible during normal use. In order to disconnect the radio from the mains completely, the mains adaptor should be removed from the mains socket outlet completely.

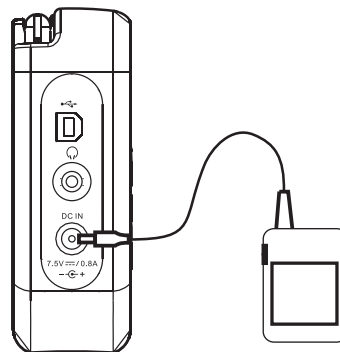

Lock switch

The Lock switch is used to prevent unintentional operation of your radio.

1. Set the **Lock switch** located on the back of your radio to the 'Lock' position (up). The power and all other buttons will be disabled, this will prevent accidental operation when your radio is packed in a suitcase or travel bag.
2. To release the lock, slide the **Lock switch** down to the 'Unlock' position (down).

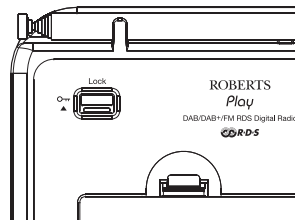

Operating your radio - DAB

1. Carefully extend the telescopic aerial.
2. Press and release the **On / Off** button to switch on your radio. The display will show *'Welcome to Digital Radio'* for a few seconds.
3. If this is the first time the radio is used a scan of the UK Band III DAB channels will be carried out. If the radio has been used before the last used station will be selected.
4. During the scanning process, as new stations are detected the station counter on the right hand side of the display will increase and stations will be added to the list. The lower line of the display shows a bar-graph indicating progress of the autotune.
5. When the scanning is completed the first station (in numeric-alpha order 0...9...A...Z) will be selected.
6. If the station list is still empty after the scan your radio will display *'Service not available'*.
7. If no signals are found it may be necessary to relocate your radio to a position giving better reception.



Welcome to
Digital Radio

Welcome to DAB28
■■■■■■■■

BBC Radio 4
Now Tuning...

BBC Radio 4
I'm sorry I have

BBC Radio 4
Service not avai

Selecting a station - DAB

1. The top line of the display shows the name of the station currently selected.
2. Press and release the **Band** button until the DAB band is selected.
3. Press and release the **Tuning Up** or **Down** buttons to scroll through the list of available stations.
4. Press and release the **Select** button to select the station. The display may show 'Now Tuning...' while your radio finds the new station.
5. Adjust the **Volume** buttons to the required setting.

Note: If after selecting a station the display shows 'Service not available' it may be necessary to relocate your radio to a position giving better reception.

The use of the station presets for selecting radio stations is described on page 19.

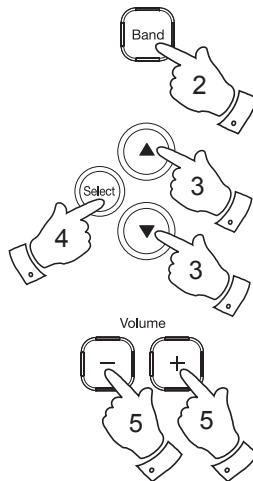

Planet Rock
Now playing that

Station List
◆BBC R4◆

BBC Radio 4
Now Tuning...

Secondary services - DAB

1. Certain radio stations have one or more secondary services associated with them. If a station has a secondary service associated with it the display will show ">>" next to the station name on the station list. The secondary service will then appear immediately after the primary service as you press the **Tuning Up** button.
2. Press and release the **Select** button to select the station.

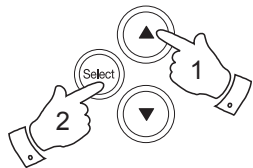

Station List
◆BBC R5L >>◆

Station List
◆ << BBC R5SX ◆

Display options - DAB

When in DAB mode your radio has a range of display options.

1. Press and release the **Info** button to cycle through the various options.

- | | | |
|----|-----------------------|--|
| a. | Scrolling text | Displays scrolling text messages such as artist/track name, phone in number etc. |
| b. | Program Type | Displays the type of station being listened to on e.g. Pop, Classic, News etc. |
| c. | Multiplex Name | Displays the name of DAB multiplex to which the current station belongs. |
| d. | Time and date | Displays the current time and date. |
| e. | Channel & Frequency | Displays the channel number and frequency for the currently tuned DAB station. |
| f. | Bit rate & audio type | Displays the digital bit rate & audio type for the station being listened to. |
| g. | Signal strength | Displays the signal strength for the currently tuned DAB station. The open block in the signal strength graph shows the minimum signal strength needed for good DAB reception. The signal blocks will go up or down showing the changing signal strength as you adjust the aerial or the radio position. |

•Advanced



- | | |
|---|---------------------------------|
| a | BBC Radio 4
I'm sorry I have |
| b | BBC Radio 4
Talk |
| c | BBC Radio 4
BBC National DAB |
| d | BBC Radio 4
14:31 08-10-2012 |
| e | BBC Radio 4
12B 225.648MHz |
| f | BBC Radio 4
128kbps / MP2 |
| g | BBC Radio 4
■■■■■□■■ |

Finding new stations - DAB

From time to time, new DAB radio stations may become available. Or you may have moved to a different part of the country. In this case you may need to cause your radio to scan for new stations.



1. Press and release the **Auto Tune** button. The display will show 'Scanning'. Your radio will perform a scan of the Band III DAB channels. As new stations are found the station counter on the right-hand side of the display will increase and stations will be added to the list.

Autoselect - DAB

As an alternative to pressing the **Select** button to select a station your radio can be set so as to automatically select a station.

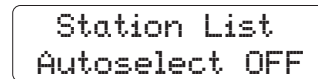
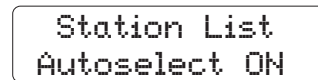
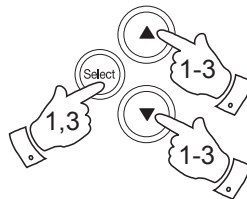

1. Press and release either the **Tuning Up** or **Down** buttons then immediately press and hold down the **Select** button until the display shows 'Autoselect ON'.
2. Press the **Tuning** buttons until the station you require is visible on the display. After a few seconds your radio will automatically select the station shown on the display.
3. To switch off autoselect press and release the **Tuning Up** or **Down** buttons then immediately press and hold down the **Select** button until the display shows 'Autoselect OFF'.

Manual tuning - DAB

Manual tuning allows you to tune directly to the various DAB Band III channels. UK DAB stations are located in the range 11B to 12D.

1. Press and hold the **Info** button until the Advanced DAB menu is displayed and then release the Info button.
2. Press and release the **Tuning Up** or **Down** buttons until 'Manual Tune' shows on the display and then press and release the **Select** button to enter the manual tune menu.
3. As an alternative to steps 1 and 2, you can simply press and hold the **Select** button to enter the manual tune menu.
4. Press and release the **Tuning Up** or **Down** buttons to select the required DAB channel.
5. Press and release the **Select** button to select the required DAB channel. The clear unfilled rectangle indicates the minimum signal level required for satisfactory reception. The signal strength bar will go up and down showing the changing signal strength as you adjust the telescopic aerial or your radio.
6. When a DAB signal is found, the display will show the name of the DAB multiplex. Any new radio stations found will be added to the list stored in the radio.
7. Press and release the **Select** button to return to normal tuning after a few seconds.

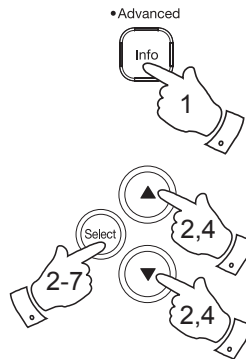

Manual Tune
◆12B 225.648MHz◆

■■■■■□■■
12B 225.648MHz

BBC Radio 1
Now Tuning...

Dynamic Range Control settings - DAB

Dynamic Range Control (also known as DRC) can make quieter sounds easier to hear when your radio is used in a noisy environment.

1. Press and release the **On / Off** button to switch on your radio. Ensure your radio is in DAB mode.
2. Press and hold the **Info** button until the Advanced DAB menu is displayed and then release the Info button.
3. Press the **Tuning Up** or **Down** buttons until the display shows 'DRC Value'.
4. Press and release the **Select** button to enter adjustment mode.
5. Press the **Tuning Up** or **Down** buttons to select the required DRC setting (the default is 0).
 - DRC 0 - DRC is switched off, Broadcast DRC will be ignored.
 - DRC 1/2 - DRC level is set to 1/2 that sent by broadcaster.
 - DRC 1 - DRC is set as sent by broadcaster.
6. Press and release the **Select** button to confirm the setting. The display will return to normal tuning mode.

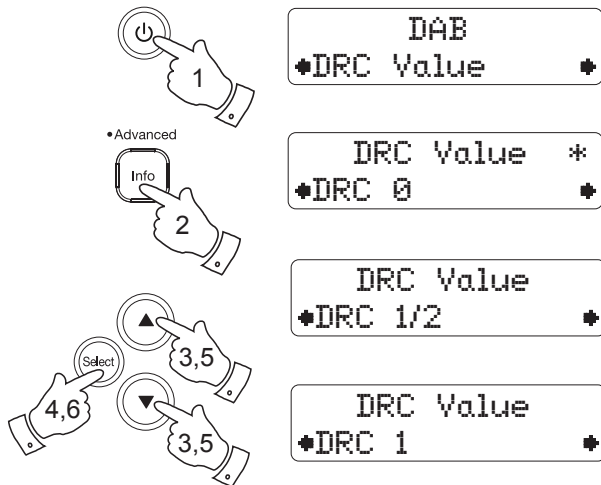

Note: Not all DAB broadcasts are able to use the DRC function. If the broadcast does not support DRC, then the DRC setting in the radio will have no effect.

Prune stations - DAB

If you move to a different part of the country, some of the stations which were listed may no longer be available. Also, from time to time, some DAB services may stop broadcasting, or may change location or frequency. Stations which cannot be found, or which have not been received for a very long time are shown in the station list with a question mark.

The Prune stations function will delete the marked DAB stations from your station list.

1. Press and release the **On / Off** button to switch on your radio. Ensure your radio is in DAB mode.
2. Press and hold the **Info** button until the Advanced DAB menu is displayed and then release the Info button.
3. Press the **Tuning Up** or **Down** buttons until the display shows 'Prune'. Press and release the **Select** button.
4. To cause the stations list to be pruned, eliminating unavailable stations press the **Tuning Up** or **Down** buttons until 'Yes' is highlighted on the display.
5. Press and release the **Select** button to cause the invalid station names to be removed from the station list.

If you do not wish to prune stations, highlight 'No' and then press and release the **Select** button. The display will revert back to the previous menu.

Note: If you have moved your radio to a different part of the country you should carry out a search for new stations (please see the section 'Finding new stations' on page 10).

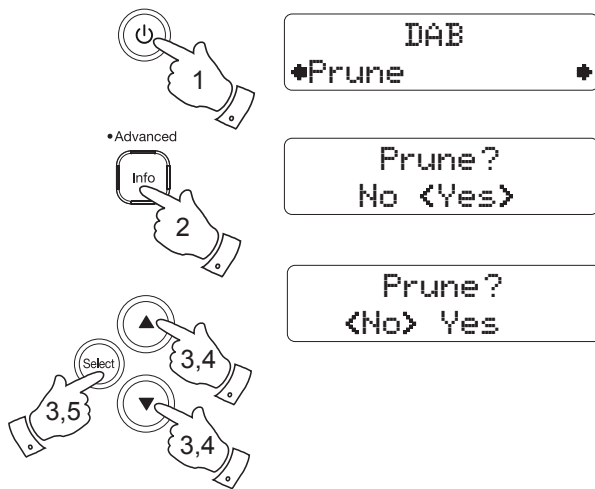

Operating your radio - FM

1. Carefully extend the telescopic aerial. The aerial should be fully extended and positioned vertically for optimum reception.
2. Press the **On / Off** button to switch on your radio.
3. Press the **Band** button to select the FM band.
4. Press and release the **Auto Tune** button. This will cause your radio to search from low frequency to high frequency and to stop automatically when it finds a station of sufficient strength.
5. The display will show the frequency of the signal which has been found. If RDS information is available, after a few seconds the display may show the radio station name. The display may also show 'St' and 'RDS' on the upper line if the station is received with stereo and RDS information.
6. Press and hold down the **Auto Tune** button for 2 - 3 seconds. This will cause your radio to search from high frequency to low frequency and to stop automatically when it finds a station of sufficient strength.
7. When the end of the waveband is reached your radio will recommence tuning from the opposite end of the waveband.
8. Adjust the **Volume** buttons to the required setting.
9. To switch off your radio press the **On / Off** button.

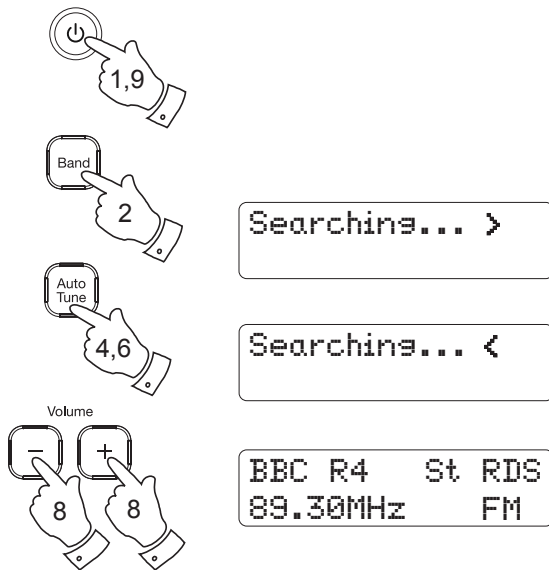

Note: If you find that FM reception is poor, try repositioning the Telescopic aerial. Fully extend and position vertically for optimum reception. If you find that an FM broadcast has a lot of background hiss, this may often be reduced by setting the radio into Mono reception mode for the current FM station. Please refer to the section 'Stereo/Mono setting - FM' on page 17 for further details.

Manual tuning - FM

1. Carefully extend the telescopic aerial. The aerial should be fully extended and positioned vertically for optimum reception.
2. Press and release the **On / Off** button to switch on your radio.
3. Press and release the **Band** button to select the FM band.
4. Press and release either the **Tuning Up or Down** buttons to tune to a station. The frequency will change in steps of 50kHz. Pressing and holding one of the buttons will advance the frequency selection several times each second.
5. When the end of the waveband is reached the radio will recommence tuning from the opposite end of the waveband.
6. Adjust the **Volume** buttons to the required setting.
7. To switch off your radio press the **On / Off** button.

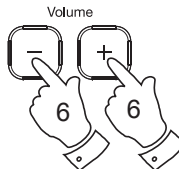
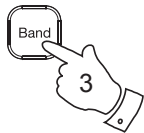

BBC R4	St	RDS
89.30MHz		FM

Note: If you find that FM reception is poor, try repositioning the Telescopic aerial. Fully extend and position vertically for optimum reception. If you find that an FM broadcast has a lot of background hiss, this may often be reduced by setting the radio into Mono reception mode for the current FM station. Please refer to the section '*Stereo/Mono setting - FM*' on page 17 for further details.

Display options - FM

When in FM mode your radio has a range of display options.

1. Press and release the **Info** button to cycle through the various options.

- a. Radio text Displays scrolling text messages such as artist/track name, phone in number etc.

- b. Program Type Displays the programme information for the station being listened to e.g. Pop, Classic, News, etc.

- c. Time and date Displays the current time and date.

- d. Frequency Displays the frequency of the station being listened to.

Note: These FM mode information displays are only available when the radio is able to receive RDS information from the broadcaster.

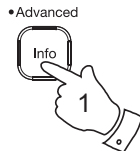

a

BBC R4	St RDS
The latest news	

b

BBC R4	St RDS
Pop Music	

c

BBC R4	St RDS
15:34 08-10-2012	

d

BBC R4	St RDS
89.30MHz	FM

Stereo / Mono setting - FM (via headphones only)

Your radio will play stereo broadcasts in stereo (via headphones) so long as the received signal is of adequate strength. However, as a stereo signal becomes weaker the audio signal will become poorer. It may be preferable to force the radio to play the station in mono in order to reduce the level of audio noise.

1. Press and release the **On / Off** button to switch on your radio.
2. Tune to the required FM radio station as previously described.
3. If a station being received is weak some hiss may be audible. To reduce this, press and release the **Select** button so that the display shows '*Force Mono*'. Your radio will switch to mono mode.
4. To return to stereo/mono mode, press and release the **Select** button so that the display shows '*Auto stereo/mono*'.



Scan sensitivity setting - FM

Your radio will normally scan for FM broadcasts which are strong enough to give good reception. However, you may wish the Auto-scan function to also be able to find weaker signals, possibly from more distant radio transmitters. Your radio includes a local / distant option for the Auto-scan function.

1. Press and release the **On / Off** button to switch on your radio.
2. If needed, press and release the **Band** button to select the FM band.
3. Press and hold the **Info** button until the Advanced FM menu shows on the display and then release the Info button.
4. Press the **Tuning Up** or **Down** buttons until the display shows 'FM Scan Zone'. Press and release the **Select** button to enter the scan zone selection menu.
5. Press the **Tuning Up** or **Down** buttons to switch between Local and Distant options on the lower line of the display. The Distant option will allow the radio to find weaker signals when scanning. The current setting will be marked with an asterisk.
6. Press and release the **Select** button to confirm your selection. The radio will then revert to the normal information display. The Local or Distant setting is stored in the radio and remains in force until changed or until a System Reset.

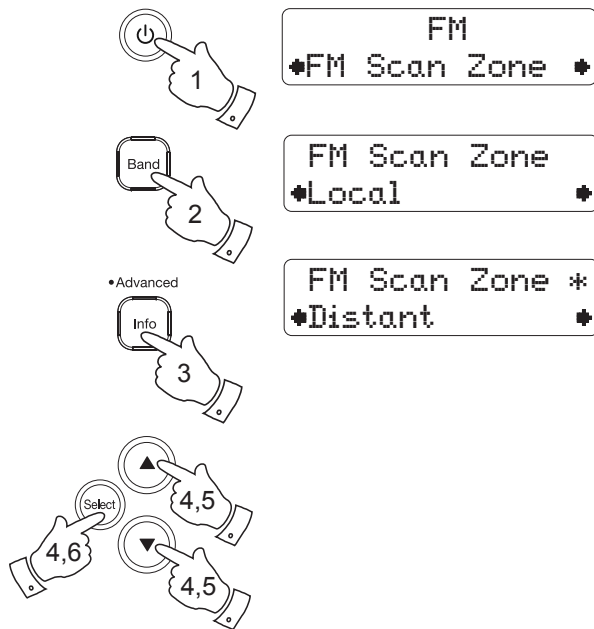

Presetting stations - DAB and FM

You may store your preferred DAB and FM radio stations to the preset station memories. There are 5 memory presets for each of the two wavebands.

Presets are remembered by your radio in the event of a power failure.

The procedure for setting presets and using them to tune stations is the same for FM and DAB modes and is described below.

1. Press and release the **On / Off** button to switch on your radio.
2. Tune to the required station as previously described.
3. Press and hold the required **Preset** button until the display shows, for example, *'Preset 1 stored'*. The station will be stored under the chosen preset button. Repeat this procedure for the remaining presets.
4. Stations stored in the presets may be overwritten by following the above procedure.

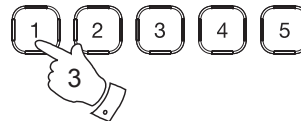

BBC Radio 4
Preset 1 stored

Recalling a preset - DAB and FM

1. Press and release the **On / Off** button to switch on your radio.
2. Select the required waveband.
3. Momentarily press and release the required **Preset** button. Your radio will then tune to the station stored in preset memory.

Note: The display will show *'Preset 1 Empty'* if no station has been stored to that preset.

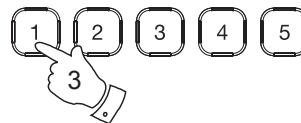

BBC Radio 4
Now Tuning...

Software version

The software display cannot be altered and is just for your reference.

1. To view the software version on the display press and hold the **Info** button until the Advanced DAB or FM menu shows on the display and then release the Info button.
2. Press the **Tuning Up** or **Down** buttons until 'SW Version' appears on the display.
3. Press and release the **Select** button to view the software version.
4. Press and release the **Info** button to exit the software version display.

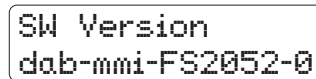
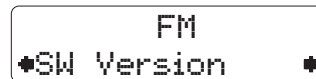
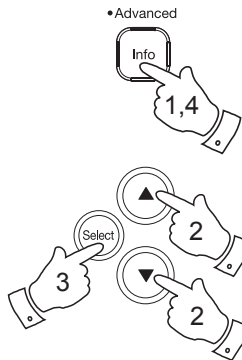

Language function

Your radio can be configured to a different language. Ensure your radio is switched on.

1. Press and hold the **Info** button until the Advanced DAB or FM menu shows on the display and then release the Info button.
2. Press the **Tuning Up** or **Down** buttons until 'Language' appears on the display.
3. Press and release the **Select** button to enter the language adjustment menu.
4. Press the **Tuning Up** or **Down** buttons until your desired language appears on the display.
5. Press and release the **Select** button to confirm your choice. The display will change to the chosen language.

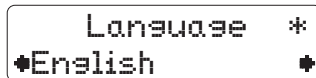
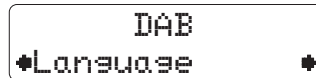
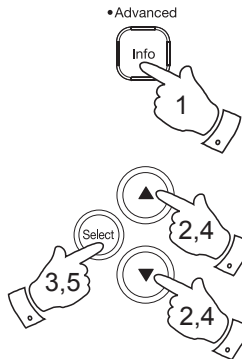

System reset

If your radio fails to operate correctly, or some digits on the display are missing or incomplete carry out the following procedure.

1. Press and hold the **Info** button until the Advanced DAB or FM menu shows on the display and then release the Info button.
2. Press and release the **Tuning Up** or **Down** buttons until the display shows *'Factory Reset'*, then press the **Select** button. *'Press SELECT to confirm reset...'* will show on the display.
3. If you wish to perform the reset operation, press the **Select** button **one more time**. A full reset of your radio will be performed. All presets and station lists will be erased.
4. After a system reset a scan of the DAB band will be performed.

In case of malfunction due to electrostatic discharge, reset the product (reconnection of power source may be required) to resume normal operation.

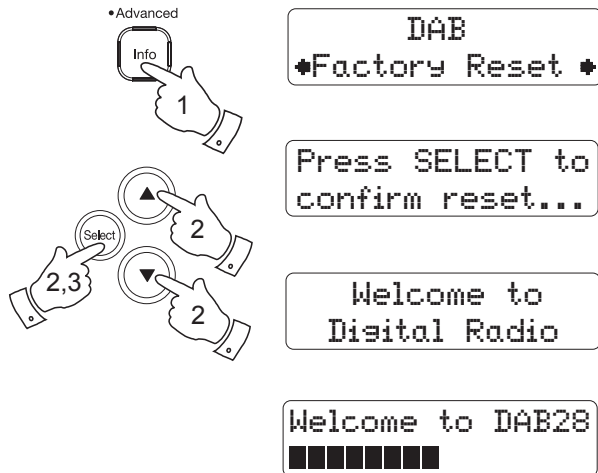

Headphone socket

A 3.5mm **Headphone Socket** located on the left hand side of your radio is provided for use with either headphones or an earpiece. Inserting a plug automatically mutes the internal loudspeaker.

Please be aware that the sensitivity of headphones can vary widely. We therefore recommend setting the volume to a low level before connecting headphones to the radio.

IMPORTANT: Excessive sound pressure from earphones and headphones can cause hearing loss.



To prevent possible hearing damage, do not listen at high volume levels for long periods.

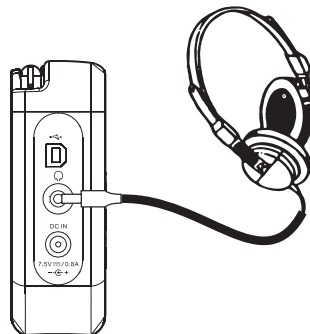

Display backlight

1. When using on batteries, the display backlight will be switched on for approximately 12 seconds when any button is pressed.
2. When your radio is powered by AC mains the display backlight will always be on when the radio is switched on.

USB socket for software upgrade

In the event that any software update is made available for your radio information on how to update your radio will be made available via our website at <http://www.robertsradio.com>

A Few Words about Batteries...

Your Roberts Play radio has been designed to use a choice of power sources. You may plug it into the mains using the supplied high-efficiency adaptor, or for listening away from the mains you may use either alkaline or rechargeable batteries. We do not recommend the use of carbon-zinc or zinc-chloride batteries.

It is very important that you read the advice and warnings given below.

- 1) Whichever type of batteries you choose to use, it is very important that the battery selection switch under the cover is set to the correct type.
 - a. If no batteries are fitted, then set the switch to the Alkaline position (to the right as viewed from the back of the radio). This position minimises the power consumption when the radio is powered from the mains.
 - b. If Alkaline batteries are fitted, then set the switch to the Alkaline position (to the right as viewed from the back of the radio).
 - c. If Rechargeable batteries are fitted, then set the switch to the NiMH position (to the left as viewed from the back of the radio). Your radio is designed to use Nickel-Metal-Hydride rechargeable batteries. No other type of rechargeable battery should be used in the radio.
- 2) **NEVER** mix old and new Alkaline batteries. The old batteries may suffer damage and leak which will damage your radio and whatever the radio is standing on.
- 3) **NEVER** mix old and new Rechargeable batteries. This may result in unreliable charging and shortened battery life. Never mix Rechargeable batteries of different types or capacities even if they are new.
- 4) **NEVER** mix Alkaline and Rechargeable batteries. The recharging of Alkaline batteries can be very dangerous.

Rechargeable batteries

Your Play radio uses a range of methods to ensure correct and safe charging of Rechargeable Nickel-Metal-Hydride batteries. These work to protect your batteries from excessive charge and discharge. These protections can only work properly if the advice above is followed. In particular, the radio will not be able to correctly charge batteries if they are a mixture of different brands, or different ages, or different capacities.

We recommend that all the rechargeable batteries used in your radio are bought together as a set. They should always be charged together and discharged together and not "borrowed" from time to time for other applications. This will ensure that they give their optimum performance in your radio.

We recommend that the rechargeable batteries that you use should be from a quality brand, and should be of at least 2000mAh capacity. Batteries of this capacity should be able to power your radio for between 10 and 20 hours depending upon the volume of the radio, whether DAB or FM mode is used (DAB mode uses slightly less power than FM), and also depending on the condition of the batteries.

Before you first install a new set of rechargeable batteries into your radio you should first make sure that the battery type switch beneath the battery cover is in the NiMH position. Install the batteries arranging them as shown on the back of the radio. Plug the mains adaptor into a mains socket and then into the radio. While the batteries are charging the battery indicator should show a flashing green light. When the batteries are fully charged the indicator will stop flashing and will show a steady green light. The time taken to charge the batteries will depend on how much charging they require. New batteries may be partly charged when first fitted, but it is normal for a set of batteries to take several hours to charge fully (this can be between 5 and 8 hours depending on the battery capacity and their initial state of charge).

If you use the radio powered from the batteries, the battery light will be off until the batteries are exhausted. The battery light will then show red for a short while before the radio switches itself off. It does this in order that the batteries are not excessively discharged. This would otherwise damage the batteries and shorten their life.

If you use the radio powered from the mains with rechargeable batteries fitted, the charging process is suspended until you switch off the radio. When you switch off the radio using its On/Off button charging will then resume. If the batteries have already been charged then they will only charge for a few more minutes before the battery indicator stops flashing.

If you only listen to your radio for short periods, you do not need to connect your radio to the mains to charge the batteries every time that you use it. However, if the radio is not to be used for a few weeks, then we recommend that the batteries are fully charged (battery light shows steady green) before the radio is put to one side.

If you intend not to use your radio for some months, then we recommend that the batteries are removed and put away, keeping them in a cool place out of reach of children, away from moisture and such that no metal object can contact the battery terminals.

With care, rechargeable batteries can last a long time and can operate for many hundreds of charge and discharge cycles. When your rechargeable batteries can no longer power your radio adequately, please dispose of them thoughtfully.

To avoid danger and risk of injury, please follow these guide lines

Improper use of batteries may result in leakage of fluid, overheating or explosion. Battery fluid is corrosive and may also be toxic. Battery fluid can cause skin burns, can damage the eyes, and can be harmful if swallowed.

1. Keep batteries out of the reach of children.
2. Do not heat, open, puncture, mutilate or dispose of batteries by burning.
3. Do not mix different battery types or old and new batteries. Always replace all the batteries at the same time.
4. Do not carry or store batteries such that metal objects may contact the end caps.
5. Remove batteries from the radio if they are worn out or if you are storing it for a long time.
6. Remove old or worn out batteries promptly, and recycle or dispose of them according to the regulations applicable to your location.
7. If a battery does leak, remove all batteries from the product, taking care to avoid directly touching the leaked fluid. If the fluid contacts skin or clothes wash with water immediately. Before inserting new batteries, thoroughly clean the battery compartment with a damp paper towel, or follow the battery manufacturer's advice for clean up.

General

Do not allow this radio to be exposed to water, steam or sand. Do not leave your radio where excessive heat could cause damage such as in a parked car where the heat from the sun can build up even though the outside temperature may not seem too high. It is recommended that the DAB band be used wherever possible as better results in terms of quality and freedom from interference will usually be obtained than on the FM band.

The name plate is located on the back of your radio.



- Your radio should not be exposed to dripping or splashing and that no objects filled with liquids, such as vases, shall be placed on the radio.
- It is recommended to operate the product such that there is a minimum distance (10cm recommended) to adjacent objects in order to ensure good ventilation.
- The ventilation of the product should not be restricted by covering it or its ventilation openings with items such as newspapers, tablecloths, curtains etc.
- No naked flame sources such as lighted candles should be placed on the product.
- It is recommended to avoid using or storing the product at extremes of temperature. Avoid leaving the unit in cars, on window sills, in direct sunlight etc.

Specifications

Power Requirements

Mains	AC 100 ~ 240V 50/60 Hz (switching adaptor)
Batteries	4 x LR6 (AA size) Alkaline or NiMH rechargeable

Battery Life

Up to 25 hours of listening when used for 4 hours a day at normal volume using alkaline cells.

Frequency Coverage

FM	87.5-108MHz
DAB	174.928 - 239.200MHz

Circuit Features

Loudspeaker	75mm	
Output Power	0.5 Watt	
Headphone socket	3.5mm dia	
Aerial System	FM	Telescopic aerial
	DAB	Telescopic aerial

The Company reserves the right to amend the specification without notice

Guarantee

This product is guaranteed for twelve months from the date of purchase by the original owner against failure due to faulty workmanship or component breakdown, subject to the procedure stated below. Should any component or part fail during this guarantee period it will be repaired or replaced free of charge.

The guarantee does not cover:

1. Damage resulting from incorrect use.
2. Consequential damage.
3. Product with removed or defaced serial numbers.

N.B. Damaged or broken telescopic aerials will not be replaced under guarantee.

Procedure:

Any claim under this guarantee should be made through the dealer from whom the product was purchased. It is likely that your Roberts dealer will be able to attend to any defect quickly and efficiently, but should it be necessary the dealer will return the product to the company's service department for attention. In the event that it is not possible to return the product to the Roberts dealer from whom it was purchased, please contact Roberts Radio using the contact details on the www.robertsradio.com website.

For product repairs falling outside the guarantee period, please refer to the "customer care" tab on the www.robertsradio.com website.

These statements do not affect the statutory rights of a consumer.



ROBERTS RADIO LIMITED

PO Box 130
Mexborough
South Yorkshire
S64 8YT

Website: <http://www.robertsradio.com>

