

# ROBERTS

# Elise

DAB/DAB+/FM RDS digital portable radio



**DAB**  
Digital Audio Broadcasting

**DAB+**

**+** Digital  
Radio

Please read this manual before use

## Contents

<i>Controls</i> .....	2-3	<i>Software version</i> .....	19
<i>Battery operation</i> .....	4	<i>Display backlight</i> .....	19
<i>Using the AC adaptor</i> .....	5	<i>System reset</i> .....	20
<i>Operating your radio - DAB</i> .....	6	<i>Headphone socket</i> .....	21
<i>Selecting a station - DAB</i> .....	7	<i>Line out socket</i> .....	21
<i>Secondary services - DAB</i> .....	7	<i>USB socket for software upgrade</i> .....	21
<i>Display options - DAB</i> .....	8	<i>General</i> .....	22
<i>Finding new stations - DAB</i> .....	9	<i>Specifications</i> .....	22
<i>Signal strength display - DAB</i> .....	9	<i>Circuit features</i> .....	22
<i>Manual tuning - DAB</i> .....	10	<i>Guarantee</i> .....	Back page
<i>Dynamic range control - DAB</i> .....	11		
<i>Prune stations - DAB</i> .....	12		
<i>Operating your radio - FM</i> .....	13		
<i>Manual tuning - FM</i> .....	14		
<i>Display options - FM</i> .....	15		
<i>FM Stereo/Mono (headphones only)</i> .....	15		
<i>Presetting stations</i> .....	16		
<i>Recalling a preset</i> .....	16		
<i>Favourite station button</i> .....	17		
<i>Language function</i> .....	18		

## Controls

(Top)

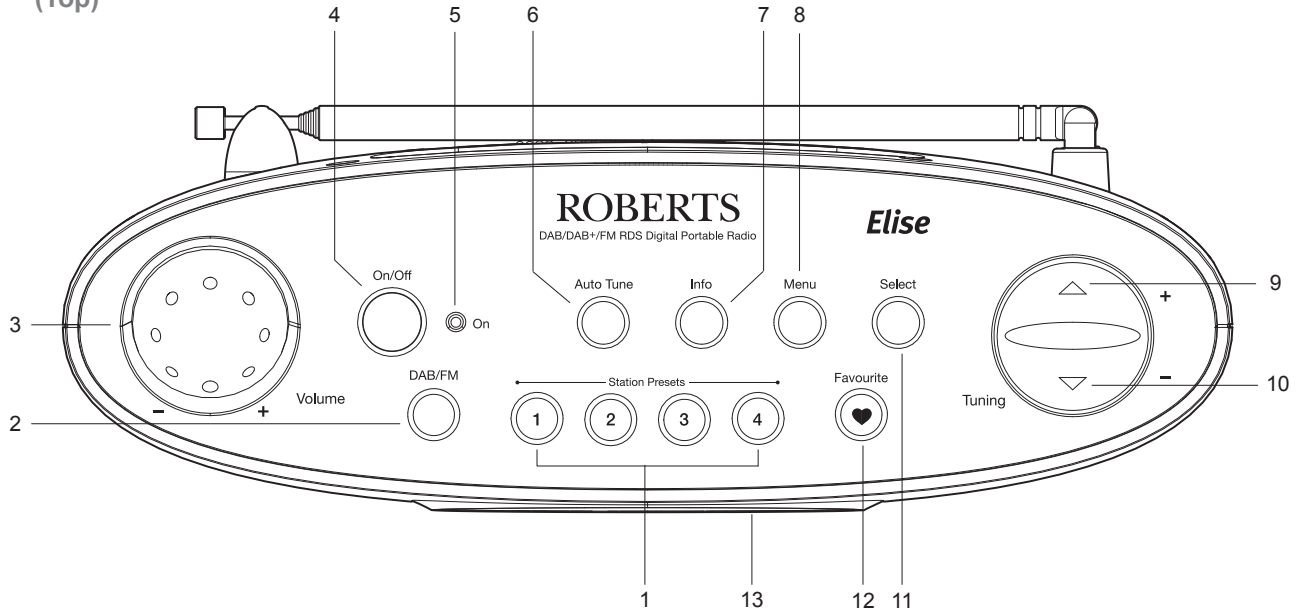

1. Preset buttons 1-4.
2. DAB / FM button
3. Volume control
4. On / Off button
5. On indicator
6. Auto Tune button
7. Info button

8. Menu button
9. Tuning Up button
10. Tuning Down button
11. Select button
12. Favourite button
13. LCD display

**Controls**  
**(Back)**

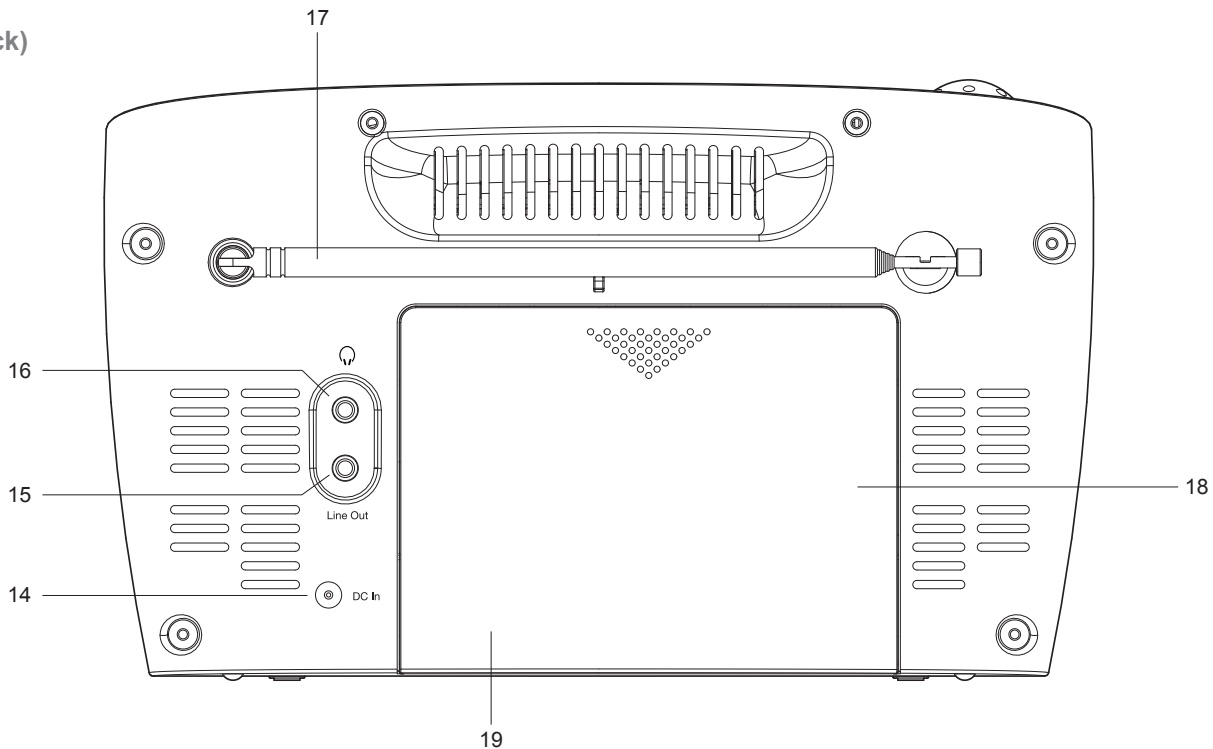

- 14. DC input socket
- 15. Line output socket
- 16. Headphone socket

- 17. Telescopic aerial
- 18. Battery compartment
- 19. USB socket (for service use only)

## Battery operation

1. Remove the battery cover on the back of the unit by sliding the cover in the direction of the arrow.
2. Insert six LR14 (C size) batteries into the spaces in the compartment. Take care to ensure all batteries are inserted with the correct polarity as shown next to the battery compartment. Replace the battery cover.
3. Reduced power, distortion and a 'stuttering' sound are all signs that the batteries may need replacing.
4. If the radio is not to be used for any extended period of time it is recommended that the batteries are removed from the radio.

*We would recommend for economy that the radio is used via the AC adaptor whenever possible with battery operation for occasional or stand-by use only.*

**IMPORTANT:** The batteries should not be exposed to excessive heat such as sunshine, fire or the like. After use, disposable batteries should if possible be taken to a suitable recycling centre. On no account should batteries be disposed of by incineration.

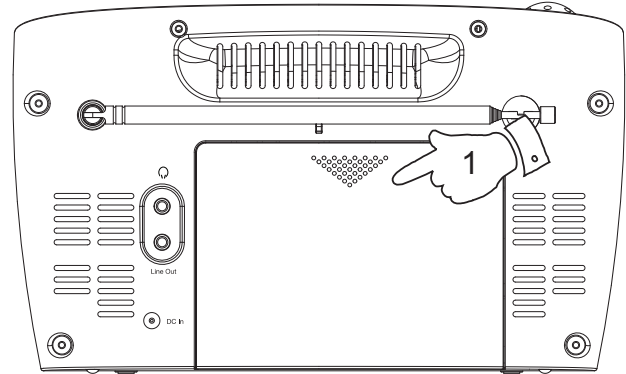

## Using the AC adaptor

1. Place your radio on a flat surface and plug the mains adaptor into the DC input socket located on the rear of your radio (marked 'DC in') ensuring that the plug is pushed fully into the socket.
2. Plug the other end of the mains adaptor into a standard mains socket outlet and switch on the wall socket. Whenever the adaptor is used the batteries are automatically disconnected.

*The AC adaptor should be disconnected from the mains supply and from the radio when not in use.*

**IMPORTANT:** The mains adaptor is used as the means of connecting the radio to the mains supply. The mains socket used for the radio must remain accessible during normal use. In order to disconnect the radio from the mains completely, the mains adaptor should be removed from the mains socket outlet completely.

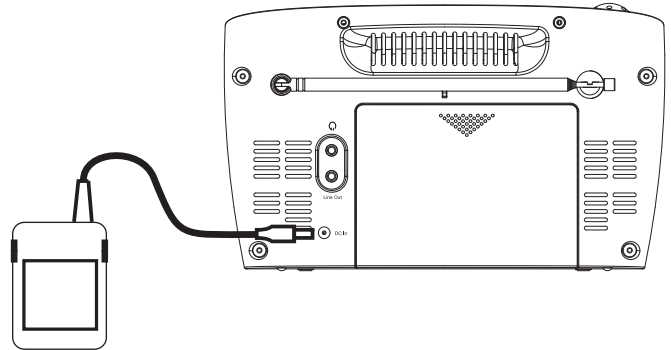

## Operating your radio - DAB

1. Carefully extend the telescopic aerial.
2. Press and release the **On/Off** button to switch on your radio. The **On** indicator will light and the display will show '*Roberts Enjoy Listening*' for a few seconds.
3. If this is the first time the radio is used a scan of the Band III DAB channels will be carried out. If the radio has been used before the last used station will be selected.
4. During the scanning process, the display will show '*Scanning*' and as each group of stations is detected the station count will be updated. The bottom line of the display shows a bar graph indicating progress of the scan.
5. When the scan is completed the first station (in numeric-alpha order 0...9...A...Z) will be selected. The first station in the list of stations found will be played. The display will show the station name in the first line of the display and other information in the second line.
6. If no signals are found it may be necessary to relocate your radio to a position giving better reception. You should then carry out an auto tune to find stations as described on page 9 (see *Finding new stations* on page 9).

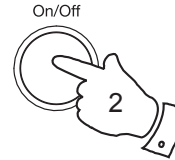

Roberts  
Enjoy Listening

Scanning... 24  
■■■■■■■■

BBC R2 DAB  
Connecting...

## Selecting a station - DAB

1. The top line of the display shows the name of the station currently selected.
2. If required, press and release the **DAB/FM** button until the DAB mode is selected.
3. Press and release the **Tuning Up** or **Down** buttons to scroll through the list of available stations.
4. Press and release the **Select** button to select the station. The display may show 'Connecting' while your radio finds the new station.
5. Rotate the **Volume** control to the required setting.

**Note:** If no signal is found it may be necessary to relocate your radio to a position giving better reception.

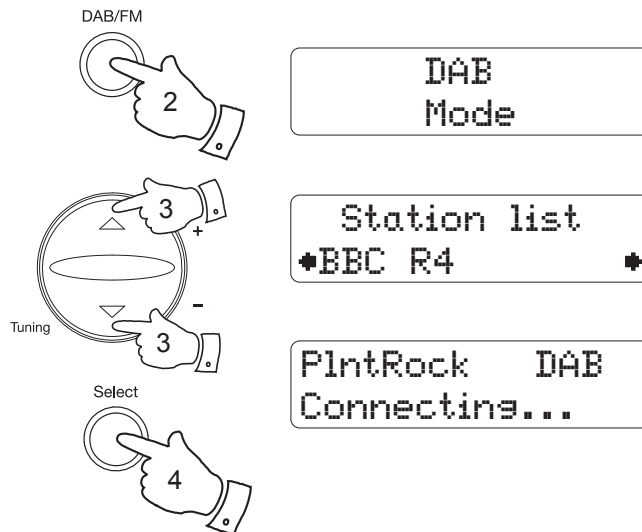

## Secondary services - DAB

1. Certain radio stations have one or more secondary services associated with them. If a station has a secondary service associated with it the display will show ">>" next to the station name on the station list. The secondary service will then appear immediately after the primary service as you press the Tuning Up button.
2. Press and release the **Select** button to select the station.

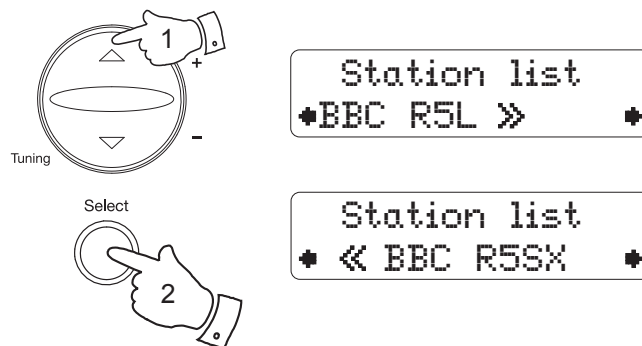



## Display options - DAB

Your radio has a range of display options when in DAB mode:-

1. Press and release the **Info** button to cycle through the various options.

- |                        |   |
|------------------------|---|
| a. Scrolling text      | Displays scrolling text messages such as artist/track name, phone in number, etc.   |
| b. Programme type      | Displays type of station being listened to e.g. Pop, Classic, News, etc.  |
| c. Multiplex Name      | Displays the name of the DAB multiplex to which the current station belongs.  |
| d. Time and date       | Displays the current time and date.   |
| e. Channel & frequency | Displays the current channel number and frequency.  |
| f. Bit rate            | Displays the digital bit rate.  |
| g. Signal error        | Displays the quality of the received DAB signal for the current station. Lower numbers mean that the radio is receiving a better signal. See also Signal Strength display on the next page. |

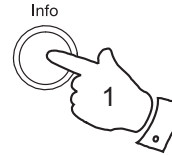

- |   |                                |
|---|--------------------------------|
| a | BBC R2 DAB<br>Now playing on t |
| b | BBC R2 DAB<br>Culture          |
| c | BBC R2 DAB<br>BBC National DAB |
| d | BBC R2 DAB<br>11:32 27-11-2013 |
| e | BBC R2 DAB<br>12B 225.648MHz   |
| f | BBC R2 DAB<br>128kbps          |
| g | BBC R2 DAB<br>Signal error: 2  |

## Finding new stations - DAB

As time passes new stations may become available. To find new stations proceed as follows:-

1. Press and release the **Auto Tune** button. The display will show 'Scanning'. Your radio will perform a scan of the Band III DAB channels. As new stations are found the station counter on the right-hand side of the display will increase and stations will be added to the list.

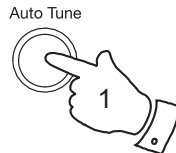

---

## Signal strength display - DAB

1. While the radio is tuned to a DAB station, press and release the **Select** button to switch between the current display mode and a bar graph which shows the currently received signal strength.
2. Position your radio and carefully angle the telescopic aerial for best reception using the signal strength display as a guide. Move your radio around and position the aerial so as to give maximum number of black rectangles on the signal strength display. The large unfilled rectangle indicates minimum signal level required for satisfactory reception.
3. Press and release the **Select** button again to exit the signal strength display.

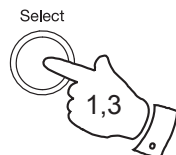

## Manual tuning - DAB

Manual tuning allows you to tune directly to the various DAB Band III channels. UK DAB stations located in the range 11B to 12D.

1. Press and release the **Menu** button.
2. Press and release either the **Tuning Up** or **Down** buttons until the display shows 'Manual tune'.
3. Press and release the **Select** button to enter the manual tune mode.
4. Press and release either the **Tuning Up** or **Down** buttons to select the required DAB channel.
5. Press and release the **Select** button to select the required DAB channel. The large unfilled rectangle shows you the minimum signal strength needed for good DAB reception. The signal strength bars will go up and down showing the changing signal strength as you adjust the telescopic aerial or your radios position.
6. When a DAB signal is found, the display will show the name of the DAB multiplex. Any new radio stations found will be added to the list stored in the radio.
7. Press and release the **Select** button to return to normal tuning.

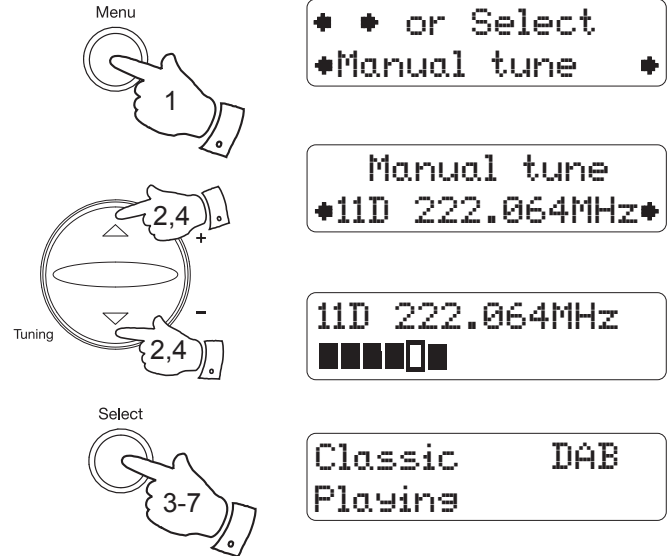

## Dynamic Range Control (DRC) settings - DAB

DRC can make quieter sounds easier to hear when your radio is used in a noisy environment.

1. Press and release the **On/Off** button to switch on your radio.
2. Press and release the **Menu** button.
3. Press and release the **Tuning Up** or **Down** buttons until the display shows 'DRC'.
4. Press and release the **Select** button to enter the adjustment mode. The current DRC setting will be marked with an asterisk.
5. Press and release the **Tuning Up** or **Down** buttons to select the required DRC setting (default is 0) .

DRC 0 DRC is switched off, Broadcast DRC will be ignored.

DRC 1/2 DRC level is set to 1/2 that sent by broadcaster.

DRC 1 DRC is set as sent by broadcaster.

6. Press and release the **Select** button to confirm the setting. The display will return to normal tuning mode.

**Note:** Not all DAB broadcasts use the DRC function. If the broadcast does not provide DRC information, then the DRC setting in the radio will have no effect.

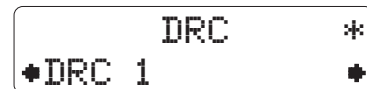
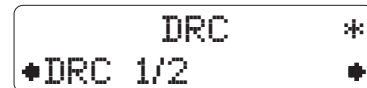
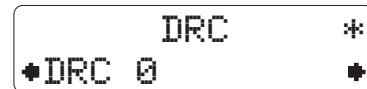
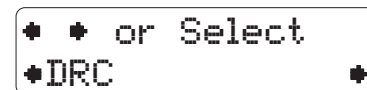
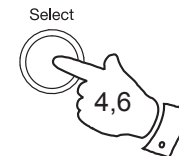
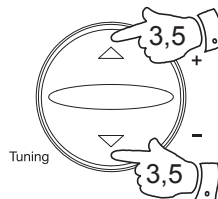
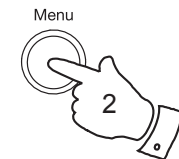
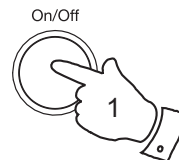

## Prune stations - DAB

Over time, some DAB services may stop broadcasting, or may change location and then not be able to receive a station. In order to remove such stations from the DAB station list, the Prune stations function will delete the DAB stations from your station list that can no longer be received.

1. Press and release the **On/Off** button to switch on your radio.
2. Press and release the **DAB/FM** button until the DAB mode is selected.
3. Press and release the **Menu** button.
4. Press and release the **Tuning Up** or **Down** buttons until the display shows 'Prune'.
5. Press and release the **Select** button.
6. Press and release the **Tuning Up** or **Down** buttons to highlight 'Yes'. Press and release the **Select** button to cause the stations list to be pruned, eliminating unavailable stations.
7. If you do not wish to prune stations highlight 'No' in step 6 and then press and release the **Select** button. The display will revert back to the previous display.

DAB/FM

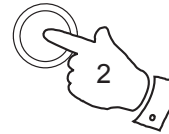

Menu

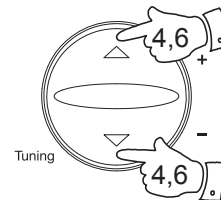

Select



◆ ◆ or Select  
◆ Prune ◆

Prune?  
No <Yes>

Prune?  
<No> Yes

## Operating your radio - FM

1. Carefully extend the telescopic aerial.
2. Press and release the **On/Off** button to switch on your radio.
3. Press and release the **DAB/FM** button to select the FM mode.
4. Press and release the **Tuning Up** button and then press and release the **Auto Tune** button. Alternatively press and hold the **Tuning Up** button for 2 - 3 seconds. Your radio will scan in an upwards direction (low frequency to high frequency) and stop automatically when it finds a station of sufficient strength.
5. After a few seconds the display will update. The display will show the frequency of the signal found. If the signal is strong enough and there is RDS data present then the radio will display the station name.
6. Press and release the **Tuning Down** button and then press the **Auto Tune** button. Alternatively press and hold the **Tuning Down** button for 2 - 3 seconds. Your radio will scan the FM band in a downwards direction (high frequency to low frequency).
7. When the waveband end is reached your radio will recommence tuning from the opposite waveband end.
8. Rotate the **Volume** control to the required setting.
9. To switch off your radio press and release the **On/Off** button.

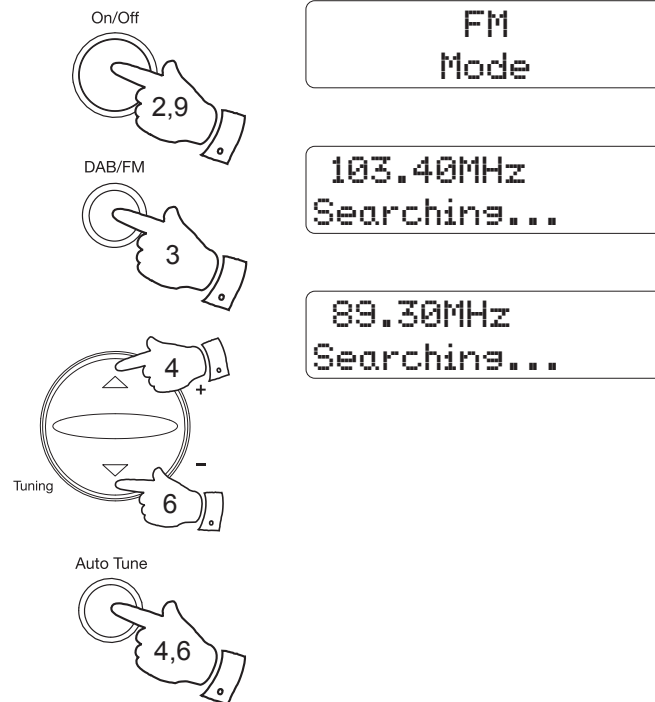

**Note:** If you find that FM reception is poor, try repositioning the Telescopic aerial. Fully extend and position vertically for optimum reception. If you find that an FM broadcast has a lot of background hiss, this may often be reduced by setting the radio into Mono reception mode for the current FM station. Please refer to the section '*FM Stereo/Mono*' on page 15 for further details.

## Manual tuning - FM

1. Press and release the **On/Off** button to switch on your radio.
2. Press and release the **DAB/FM** button to select the FM mode. Fully extend the **Telescopic aerial**.
3. Press and release either the **Tuning Up** or **Down** buttons to tune to a station. The frequency will change in steps of 50kHz.
4. When the waveband end is reached the radio will recommence tuning from the opposite waveband end.
5. Rotate the **Volume** control to the required setting.
6. To switch off your radio press and release the **On/Off** button.

**Note:** If you find that FM reception is poor, try repositioning the Telescopic aerial. Fully extend and position vertically for optimum reception. If you find that an FM broadcast has a lot of background hiss, this may often be reduced by setting the radio into Mono reception mode for the current FM station. Please refer to the section '*FM Stereo/Mono*' on page 15 for further details.

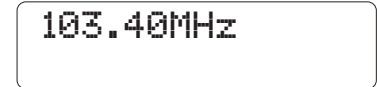
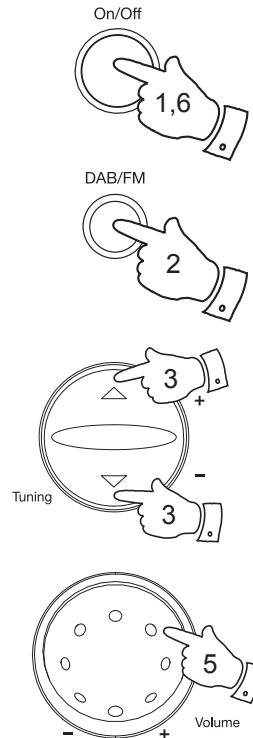

## Display options - FM

Your radio has a range of display options for the FM mode:-

The Radio Data System (RDS) is a system in which inaudible digital information is transmitted in addition to the normal FM radio programme. RDS offers several useful features. The following are available on your radio.

1. Press and release the **Info** button to cycle through the various options.

- |                   |  |
|-------------------|--|
| a. Scrolling text | Displays scrolling text messages such as artist/track name, phone in number etc. |
| b. Programme type | Displays type of station being listened to e.g. Pop, Classic, News, etc.         |
| c. Station name   | Displays the name of the FM station being listened to.                           |
| d. Time and date  | Displays the current time and date.  |

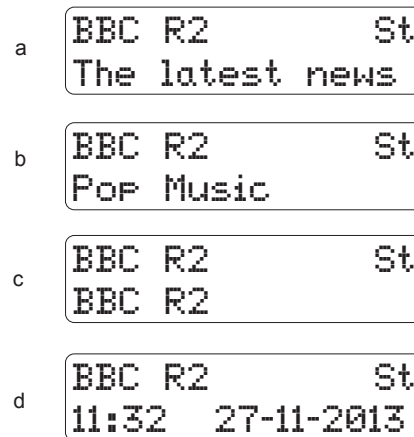
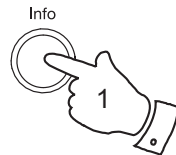

## FM Stereo/Mono (headphones only)

1. If an FM station being received is weak, some hiss may be audible. To reduce the hiss, press and release the **Select** button until the display shows 'Mono', your radio will switch to mono mode.
2. To return to stereo mode, press and release the **Select** button until the display shows 'Stereo', your radio will switch to stereo mode.

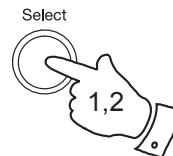



## Presetting stations

There are 4 memory presets for each of the two wavebands which allow you to quickly tune the radio to your favourite stations. Presets are stored in a memory which remembers the settings even when the radio is switched off.

1. Press and release the **On/Off** button to switch on your radio.
2. Tune to the required station as previously described.
3. Press and hold the required **Preset** button until the display shows e.g. '*Preset 1 Saved*'. The station will be stored under the chosen preset button. Repeat this procedure for the remaining presets.
4. Stations stored in the memories may be overwritten by following the above procedure.

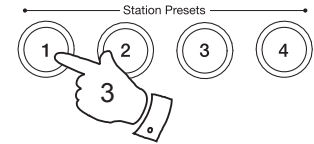
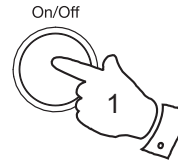

PlntRock  
Preset 1 Saved

## Recalling a preset

1. Press and release the **On/Off** button to switch on your radio.
2. Select the required waveband.
3. Momentarily press and release the required **Preset** button. Your radio will tune to the station stored in preset memory. The display will show for example, '*Preset 1 Empty*' if no station has been stored to that preset.

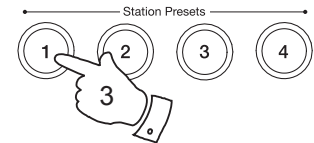
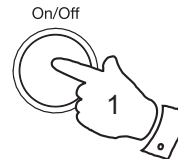

PlntRock DAB  
Connecting...

## Favourite station button

Your radio has a Favourite Station button which can automatically select the required waveband and tune to your favourite station. This button can store one favourite station from either the FM or DAB waveband.

1. To set up your favourite station, tune into the required station.
2. Press and hold down the **Favourite** button (10 sec) until the display shows 'My Fav. Saved'.

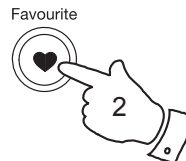

BBC R2 DAB  
My Fav. Saved

## Recalling your favourite station

1. Press and release the **On/Off** button to switch on the radio.
2. Press and release the **Favourite** button, your radio will tune to the station stored in favourite memory.

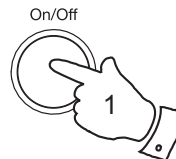

BBC R2 DAB  
Just a minute...

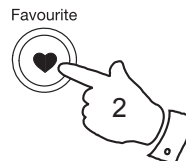

## Language function

Your radio can be configured to a different language.

1. Press and release the **On/Off** button to switch on your radio.
2. Press and release the **Menu** button.
3. Press and release the **Tuning Up** or **Down** buttons until the display shows 'Language'.
4. Press and release the **Select** button to enter the language adjustment menu.
5. Press and release the **Tuning Up** or **Down** buttons until your desired language appears on the display.
6. Press and release the **Select** button to confirm your choice. The display will change to the chosen language. The chosen language will be marked with an asterisk.

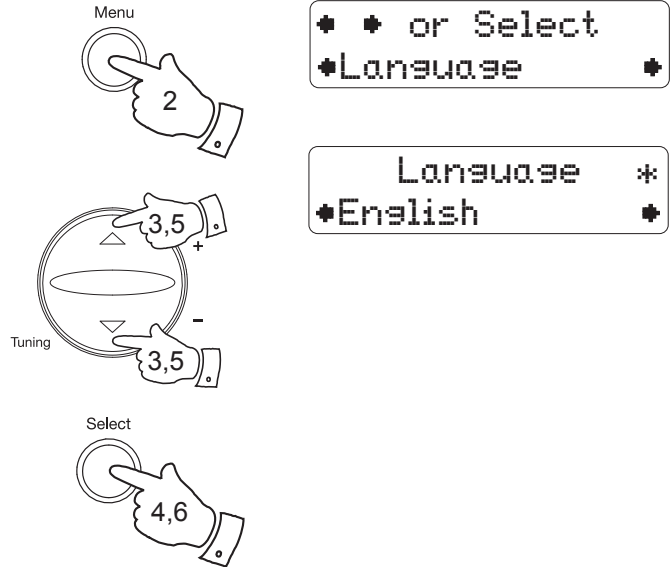

## Software version

The software display cannot be altered and is just for your reference.

1. Press and release the **On/Off** button to switch on your radio.
2. Press and release the **Menu** button.
3. Press and release the **Tuning Up** or **Down** buttons until the display shows 'SW version'.
4. Press and release the **Select** button. The display shows the software information.
5. Press and release the **Menu** button to exit the software display.

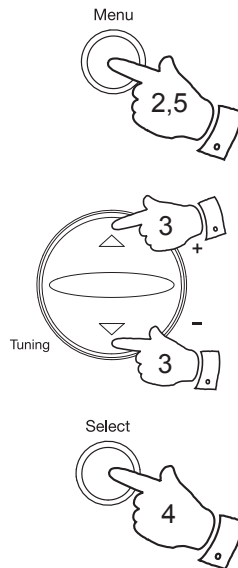

◆ ◆ or Select  
◆ SW version ◆

SW version  
dab-mmi-FS2052-0

## Display backlight

1. When using your radio on batteries, the display backlight will be switched on for approximately 12 seconds when any button is pressed.
2. When your radio is powered by AC mains the display backlight will always be switched on.

## System reset

If your radio fails to operate correctly, or some digits on the display are missing or incomplete carry out the following procedure.

1. Press and release the **On/Off** button to switch on your radio.
2. Press and release the **Menu** button.
3. Press and release the **Tuning Up** or **Down** buttons until the display shows 'Factory Reset'.
4. Press and release the **Select** button. The display will show 'Press SELECT to confirm reset'.
5. Press and release the **Select** button again. A full reset will be performed. The station list and presets will be erased.
6. See 'Operating your radio' on page 6 for further details.

In the event of a malfunction due to electrostatic discharge, mains power supply transients or short interruptions, reset the product as above to resume normal operation. If you are not able to perform the reset operation as above, removal and reconnection of the power supply and batteries may be required.

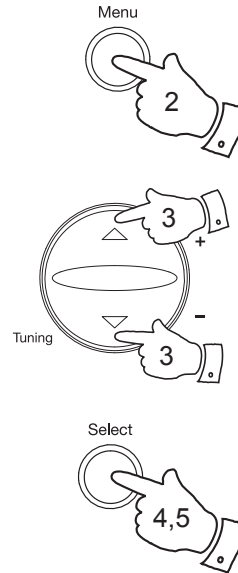

◆ ◆ or Select  
◆ Factory Reset ◆

Press SELECT to  
confirm reset

## Headphone socket

A 3.5mm **Headphone Socket** located on the rear of your radio is provided for use with either headphones or an earpiece. Inserting a plug automatically mutes the internal loudspeaker.

Please be aware that the sensitivity of headphones can vary widely. We therefore recommend setting the volume to a low level before connecting headphones to the radio.

**IMPORTANT:** Excessive sound pressure from earphones and headphones can cause hearing loss.



To prevent possible hearing damage, do not listen at high volume levels for long periods.

## Line out socket

A 3.5mm **Line out socket** located on the rear of your radio is provided for connecting the audio signal to an external amplifier. Inserting a plug into the line output socket will not mute the internal loudspeaker. Set the volume control to adjust the speaker volume level as required.

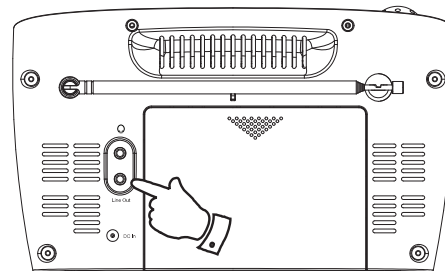
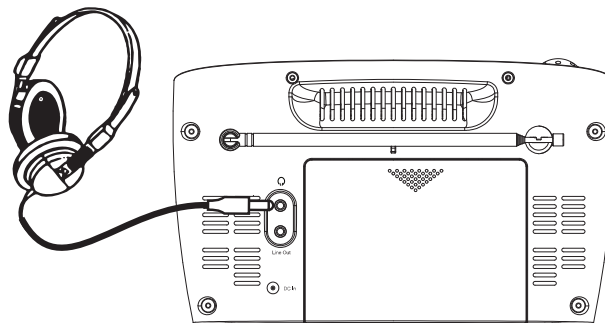

## USB socket for software upgrade

In the event that any software update is made available for your radio information on how to update your radio will be made available via our website at <http://www.robertsradio.com>

## General

Do not allow this radio to be exposed to water, steam or sand. Do not leave your radio where excessive heat could cause damage such as in a parked car where the heat from the sun can build up even though the outside temperature may not seem too high. It is recommended that the DAB band be used wherever possible as better results in terms of quality and freedom from interference will usually be obtained than on the FM band.



The name plate is located underneath your radio.

- Your radio should not be exposed to dripping or splashing and that no objects filled with liquids, such as vases, shall be placed on the radio.
- It is recommended to operate the product such that there is a minimum distance (10cm recommended) to adjacent objects in order to ensure good ventilation.
- The ventilation of the product should not be restricted by covering it or its ventilation openings with items such as newspapers, tablecloths, curtains etc.
- No naked flame sources such as lighted candles should be placed on the product.
- It is recommended to avoid using or storing the product at extremes of temperature. Avoid leaving the unit in cars, on window sills, in direct sunlight etc.
- The product must be used in a moderate climate.

---

## Specifications

### Power Requirements

Mains AC 230 volts, 50Hz ~ only (adaptor)

Batteries 6 x LR14 (C size)

### Battery Life

Approx. 45 hours of listening for 4 hours a day at normal volume using alkaline cells.

### Frequency Coverage

FM 87.5-108MHz

DAB 174.928 - 239.200MHz

## Circuit Features

Loudspeaker 76mm

Headphone socket 3.5mm dia

Output Power 1W into 8 ohms

Line out socket 3.5mm dia

Aerial System FM Telescopic aerial

DAB Telescopic aerial

*The Company reserves the right to amend the specification without notice*

## Guarantee

This product is guaranteed for twenty four months from the date of purchase by the original owner against failure due to faulty workmanship or component breakdown, subject to the procedure stated below. Should any component or part fail during this guarantee period it will be repaired or replaced free of charge.

The guarantee does not cover:

1. Damage resulting from incorrect use.
2. Consequential damage.
3. Product with removed or defaced serial numbers.

N.B. Damaged or broken telescopic aerials will not be replaced under guarantee.

Procedure:

Any claim under this guarantee should be made through the dealer from whom the product was purchased. It is likely that your Roberts dealer will be able to attend to any defect quickly and efficiently, but should it be necessary the dealer will return the product to the company's service department for attention. In the event that it is not possible to return the product to the Roberts dealer from whom it was purchased, please contact Roberts Radio using the contact details on the [www.robertsradio.com](http://www.robertsradio.com) website.

For product repairs falling outside the guarantee period, please refer to the "customer care" tab on the [www.robertsradio.com](http://www.robertsradio.com) website.

*These statements do not affect the statutory rights of a consumer.*

### ROBERTS RADIO LIMITED

PO Box 130  
Mexborough  
South Yorkshire  
S64 8YT

Website: <http://www.robertsradio.com>

