

ROBERTS

Sound for Generations



CRD-39 CLASSIC *fm*

FM RDS/DAB digital radio
with *PAUSEplus*

Please read this manual before use

DAB

Digital Audio Broadcasting

Contents

<i>Controls</i>	2-4	<i>Alarm/timers</i>	21-24
<i>Mains operation</i>	5	<i>Snooze function</i>	25
<i>Operating your radio - DAB</i>	6	<i>Cancelling alarms</i>	25
<i>Selecting a station - DAB</i>	7	<i>Auto Dimmer</i>	25
<i>Secondary services - DAB</i>	8	<i>Connecting to an external amplifier or recorder</i>	26
<i>Display modes - DAB</i>	8	<i>Recording from your radio</i>	26
<i>Finding new stations - DAB</i>	9	<i>Clock display</i>	27
<i>Autoselect - DAB</i>	9	<i>Display backlight</i>	27
<i>Manual tuning - DAB</i>	10	<i>Headphone socket</i>	27
<i>Signal strength display - DAB</i>	10	<i>Line in socket</i>	28
<i>Using your radio's Pauseplus feature</i>	11-12	<i>Optical output socket</i>	28
<i>Operating your radio - FM</i>	13	<i>Remote control</i>	29
<i>Manual tuning - FM</i>	14	<i>Remote handset battery replacement</i>	30
<i>Display modes - FM</i>	15	<i>Using the remote control</i>	31
<i>FM stereo/mono</i>	15	<i>General</i>	32
<i>Presetting stations - DAB and FM</i>	16	<i>Specifications</i>	32
<i>Recalling a preset station - DAB and FM</i>	16	<i>Circuit features</i>	32
<i>System reset</i>	17	<i>Mains Supply</i>	33
<i>Classic FM button</i>	18	<i>Guarantee</i>	34
<i>Software version</i>	18		
<i>Sleep function</i>	19		
<i>Alarm display</i>	20		

Controls

(Front)

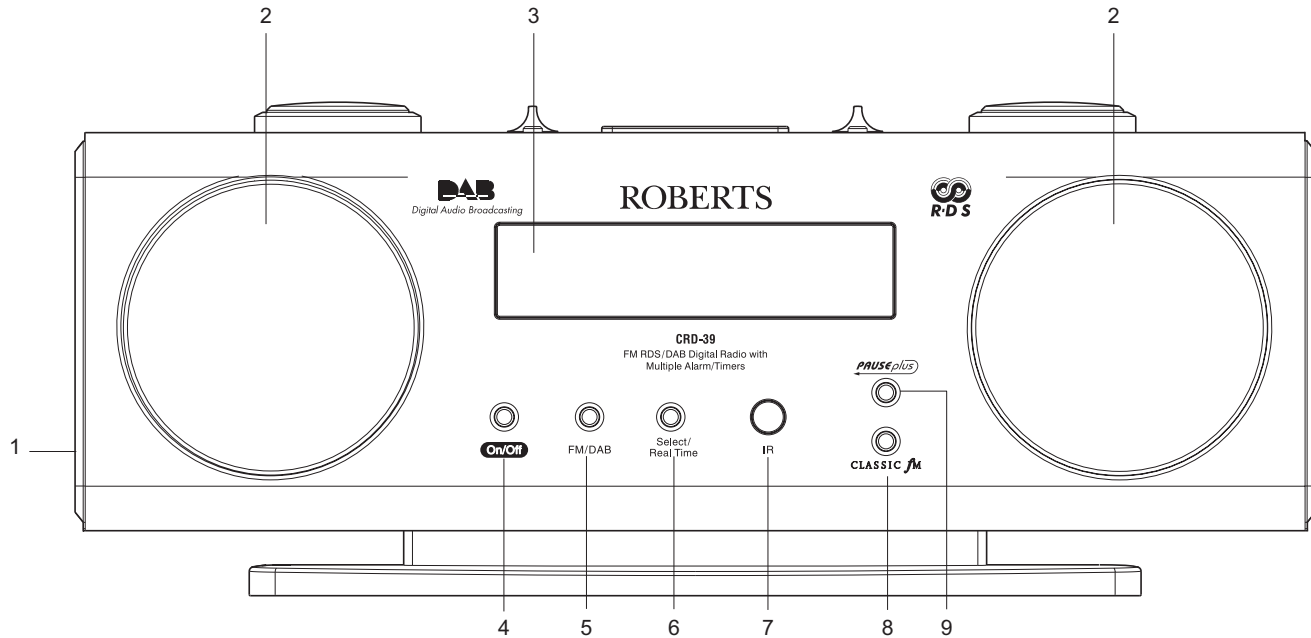

1. Headphone socket
2. Loudspeakers
3. LCD display
4. On/Off button
5. FM/DAB band button

6. Select/Real time button
7. Infra red sensor
8. Classic FM button
9. **PAUSEplus** button

If you need any further advice, please call our Technical Helpline on :-
020 8758 0338 (Mon-Fri)

Controls

(Top)

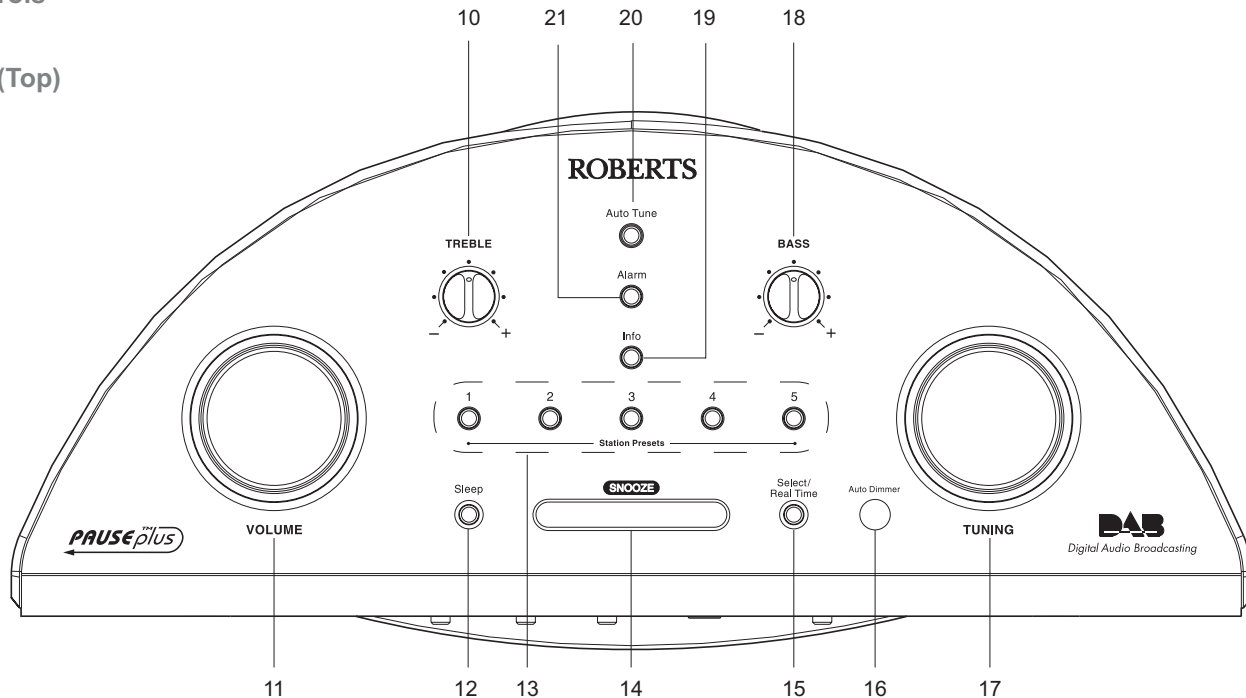

10. Treble control

11. Volume control

12. Sleep button

13. Station preset buttons

14. Snooze button

15. Select/Real time button

16. Auto dimmer

17. Tuning control

18. Bass control

19. Info button

20. Auto tune button

21. Alarm button

Controls

(Rear)

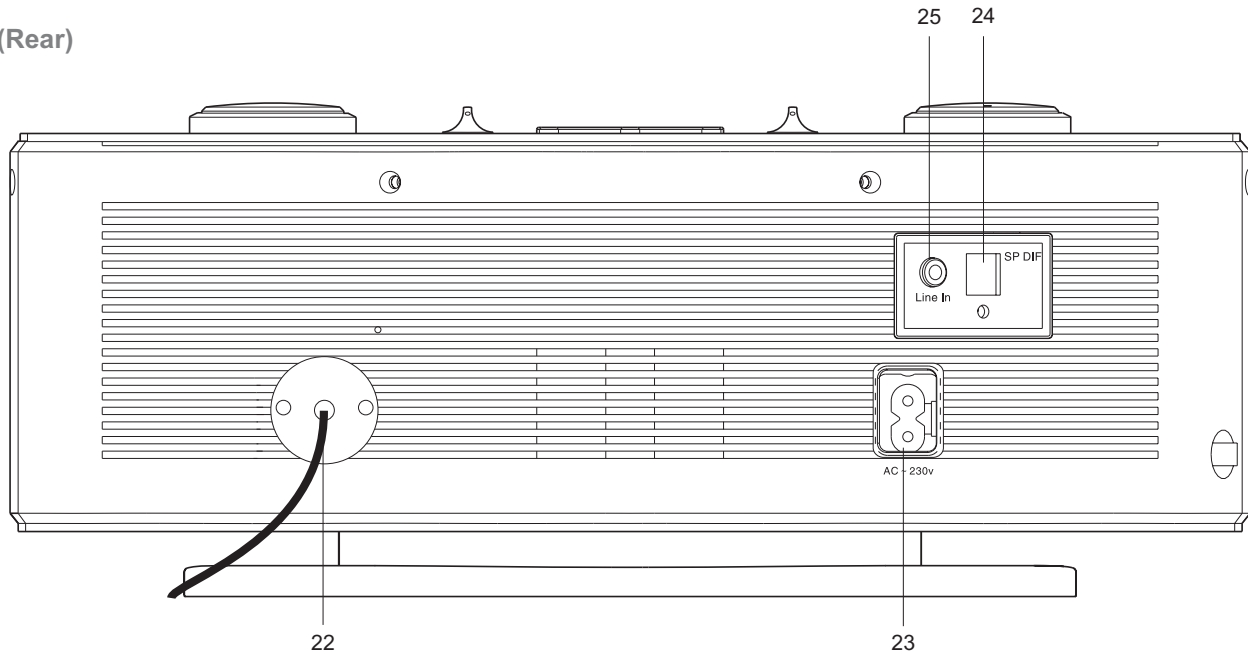

- 22. Wire DAB/FM aerial
- 23. Mains input socket
- 24. Optical output socket (toslink)
- 25. Line in socket

If you need any further advice, please call our Technical Helpline on :-
020 8758 0338 (Mon-Fri)

Mains operation

1. Place your radio on a flat surface.
 2. Plug the mains lead into the **Socket** located on the rear of your radio ensuring that the plug is pushed fully into the socket.
 3. Plug the other end of the mains lead into a wall socket and switch on the wall socket.
- ***The unit remains connected to the mains even when it is switched off. The unit is only isolated from the mains if the mains plug is removed from the wall socket.***

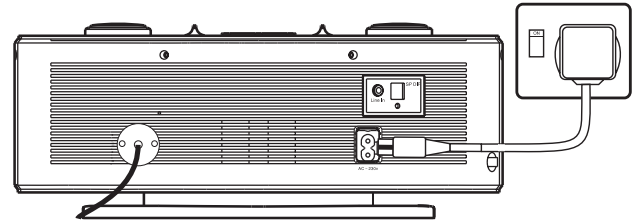

Operating your radio - DAB

1. The **Wire aerial** located on the rear of your radio is for DAB/FM reception. The wire should be fully extended and positioned for optimum reception.
2. Press the **On/Off button** to switch on your radio. The display will show "Roberts DAB digital radio" for a few seconds.
3. If this is the first time the radio is used a quick scan of UK Band III DAB channels will be carried out. The display will show "Autotune Quick scan". If the radio has been used before the last used station will be selected.
4. During Autotune as each group of stations is detected the bottom line of the display will show its name and the station count will be updated. The top line of the display shows a bargraph indicating progress of the Autotune.
5. When the Auto tune is complete the first station (in numeric-alpha order 0...9...A....Z) will be selected.
6. If the station list is still empty after the Autotune your radio will display "No Signal".
7. If no signals are found it may be necessary to relocate your radio to a position giving better reception.



Roberts

Autotune
Quick scan

■■■■□□□□□□□□
Searching...

■■■■■■■■■■ 24
Digital 1 Network

Classic FM DAB
Digital 1 Network

No signal DAB

Selecting a station - DAB

1. The top line of the display shows the name of the station currently selected.
2. Rotate the **Tuning control** to scroll through the list of available stations. Stop rotating the **Tuning control** when you find the station that you wish to hear.
3. Press the **Select/Real time button** to select the station. The display may show "Tuning" while your radio finds the new station.
4. Adjust the **Volume, bass and treble controls** to the required settings.

Note: If after selecting a station the display continues to show "Not Available" it may be necessary to relocate your radio to a position giving better reception.

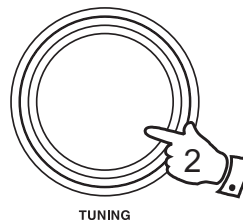

TUNING



Select/
Real Time

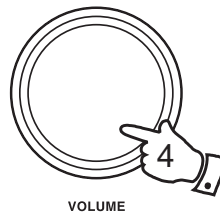

VOLUME



TREBLE



BASS

Secondary services - DAB

1. Certain radio stations have one or more secondary services associated with them. If a station has a secondary service associated with it the display will show ">" next to the station name on the station list. The secondary service will then appear immediately after the primary service as you rotate the tuning control clockwise.



Display modes - DAB

Your radio has six display modes:-

1. Press the **Info button** to cycle through the various modes.
 - a. Scrolling text Displays scrolling text messages such as artist/track name, phone in number, etc.
 - b. Programme type Displays type of station being listened to e.g. Pop, Classic, News, etc.
 - c. Multiplex Name Displays name of multiplex to which current station belongs.
 - d. Signal strength Displays signal strength for station being listened to.
 - e. Time and date Displays current time and date.
 - f. Maximum delay Displays maximum time that the current station can be delayed when using pauseplus

Info

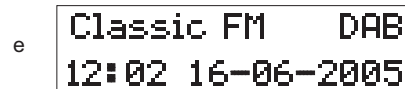
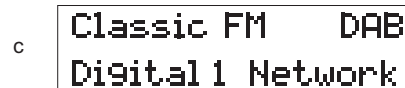

Finding new stations - DAB

As time passes new stations may become available. To find new stations proceed as follows:-

1. Press and release the **AutoTune button**, the display will show "Autotune Quick Scan". Your radio will perform a scan of the UK DAB frequencies. As new stations are found the station counter on the right-hand side of the display will increase and stations will be added to the list.
2. To carry out a full scan of the entire DAB Band III frequencies press and hold down the **AutoTune button** for more than 2 seconds and then release. The display will show "Autotune Full scan". As new stations are found the station counter on the right-hand side of the display will increase and stations will be added to the list.

Auto Tune



Autotune
Quick scan

Auto Tune



■■■■■■■■■■ 24
Digital 1 Network

Autotune
Full scan

Autoselect - DAB

As an alternative to rotating the tuning control to select a station your radio can be set so as to automatically select a station.

1. Rotate the **Tuning control** to scroll through the list of available stations.
2. Immediately press and hold in the **Select/Real time button** for 2 seconds until the display shows "Autoselect ON".
3. Rotate the **Tuning control** until the station you require is visible on the display, after a few seconds your radio will automatically select the station shown on the display.
4. To switch off Autoselect rotate the **Tuning control** to scroll through the list and immediately press and hold in the **Select/Real time button** until the display shows "Autoselect OFF".

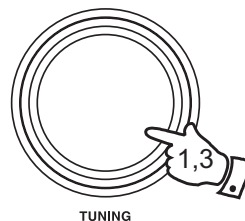

Autoselect ON

Select/
Real Time



Classic FM DAB
Digital 1 Network

Autoselect OFF

Manual Tuning - DAB

Manual tuning allows you to tune directly to the various DAB Band III channels. UK DAB stations located in the range 11B to 12D.

1. Press and hold in the **Select/Real time button** until the display shows "Manual tune".
2. Rotate the **Tuning control** to select the required DAB channel.
3. Press and release the **Select/Real time button** to select the channel.
4. Rotate the **Tuning control** to select the stations contained within the Multiplex for the selected DAB channel.
5. Press and release the **Select/Real time button** to return to normal tuning mode.



Manual tune

11D 222.064 MHz
Digital 1 Network

Classic FM MAN
Digital 1 Network

Classic FM DAB
Digital 1 Network

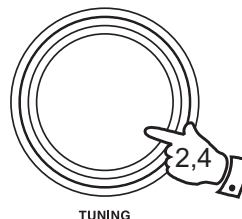

Signal strength display - DAB

1. Repeatedly press and release the **Info button** until the lower line of the display shows signal strength.
2. Position your radio and the wire aerial for best reception using the signal strength display as a guide. Move your radio around and position so as to give maximum number of black rectangles on signal strength display.
3. The clear unfilled rectangle indicates minimum signal level required for satisfactory reception.



Classic FM DAB
■■■■■□■■■■■

Using your radio's Pauseplus feature

How many times has your favourite radio station been interrupted by that phone call from a double glazing firm or someone selling that must have item? Sound familiar? Now with a single press of the **PAUSEplus** button you can put your favourite station on hold while you answer that important call. After the call or other important task is finished simply press the **PAUSEplus** button to return to your favourite station exactly where you left off so that you never miss a single word.

Radio stations can effectively be put on hold for typically 15 minutes but can be up to 35 minutes depending on the station you are listening to.

Note the **PAUSEplus feature only operates on the DAB waveband.**

1. To place your radio in **PAUSEplus** mode simply press the **PAUSEplus** button, the sound from the loudspeaker will be muted. The display will alternate between PAUSE and the time which the radio station has been on Pause.
2. To return to the radio station that you were listening to simply press the **PAUSEplus** button and your radio will continue playing from where you left off. The display will alternate between DELAY and the amount by which you are behind real time.
3. When using your radio's **PAUSEplus** feature the lower line of display automatically switches to show the Maximum delay time for the station you are listening to.
4. To return to real time press in and release the **Select/Real time button**, the display will return to show DAB in right hand corner.

PAUSEplus



Classic FM PAUSE
Max delay 23m20s

Classic FM 5m20s
Max delay 23m20s

PAUSEplus



DELAY
Max delay 23m20s

Classic FM 8m20s
Max delay 23m20s

Classic FM 8m20s
Max delay 23m20s

Select/
Real Time



Classic FM DAB
Just a Minute...

Pauseplus continued

1. Your radio's **PAUSEplus** feature is continuously working silently in the background even when your radio is in Standby mode so, say for example, you want to hear a news item again switch on your radio using the **On/off button** and press **PAUSEplus** button twice, use the **Tuning control** to scroll back to the item you wish to listen. The display will show the amount of time you have scrolled back.

Note when your radio is in standby the **PAUSEplus memory will continuously store up to 35 minutes of the last station listened to.**

2. When using your radio's **PAUSEplus** feature the lower line of display automatically switches to show the Maximum delay time for the station you are listening to.

PAUSEplus



Classic FM DAB
Just a Minute...

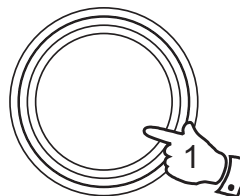

TUNING

Classic FM 8m20s
Max delay 23m20s

Operating your radio - FM

1. The **Wire aerial** located on the rear of your radio is for DAB/FM reception. The wire should be fully extended and positioned for optimum reception.
2. Press the **On/Off button** to switch on your radio. The display will show "Roberts DAB digital radio" for a few seconds.
3. Press the **FM/DAB Band button** to select the FM band.
4. Press and immediately release the **Auto Tune button**, your radio will scan in an upwards direction (low frequency to high frequency) and stop automatically when it finds a station of sufficient strength.
5. After a few seconds the display will update and show station name.
6. To find other stations press and release the **AutoTune button** as before.
7. To scan the FM band in a downwards direction (high frequency to low frequency) press and hold down the **AutoTune button** for 0.5 seconds and then release.
8. When the waveband end is reached your radio will recommence tuning from the opposite waveband end.
9. Adjust the **Volume, treble and bass controls** to the required settings.
10. To switch off your radio press the **On/Off button**.



Auto Tune

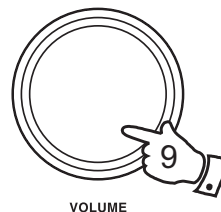

Manual tuning - FM

1. Press the **On/Off button** to switch on your radio.
2. Press the **FM/DAB Band button** to select the FM band. Fully extend the **Wire DAB/FM aerial** and position for optimum reception.
3. Rotate the **Tuning control** to tune to a station. The frequency will change in steps of 50kHz.
4. When the waveband end is reached the radio will recommence tuning from the opposite waveband end.
5. Set the **Volume, treble and bass controls** to the desired settings.
6. To switch off your radio press the **On/Off button**.

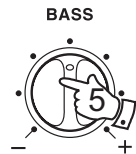
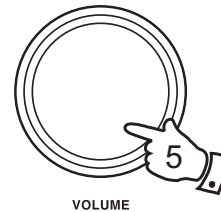
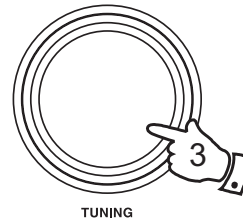

Display modes - FM

On FM the bottom line of the display can be set to any of the following modes:-

1. Press the **Info button** to cycle through the various modes.
 - a. Scrolling text Displays scrolling text messages such as artist/track name, phone in number etc.
 - b. Programme Type Displays type of station being listened to e.g. Pop, Classic, News, etc.
 - c. Signal strength Displays signal strength for station being listened to.
 - d. Time and date Displays current time and date.
 - e. Frequency Displays frequency of the station being listened to.
 - f. Audio mode Display shows Auto (stereo) or mono.



a	Classic FM	FM	The latest news
b	Classic FM	FM	Classical Music
c	Classic FM	FM	■■■■■□■■■■■
d	Classic FM	FM	12:02 16-06-2005
e	Classic FM	FM	101.1MHz
f	Classic FM	FM	Auto (Stereo)

FM Stereo/Mono

1. If a station being received is weak some hiss may be audible. To reduce the hiss repeatedly press the **Select/Real time button** until the display shows "Audio mode : mono" your radio will switch to mono mode.
2. To return to stereo mode repeatedly press the **Select/Real time button** until the display shows "Audio mode :Auto", your radio will switch to stereo mode.

Select/
Real Time



Audio mode: Mono

Audio mode: Auto

Presetting stations - DAB and FM

There are 5 memory presets for each of the 2 wavebands.

1. Press the **On/Off button** to switch on your radio.
2. Tune to the required station as previously described.
3. Press and hold down the required **Preset button** until the display shows e.g. "Preset 1 stored". The station will be stored under the chosen preset button. Repeat this procedure for the remaining presets.
4. Stations stored in preset memories may be overwritten by following the above procedure.



Classic FM DAB
Preset 1 stored

Classic FM DAB
Digital 1 Network

Recalling a preset station - DAB and FM

1. Press the **On/Off button** to switch on your radio.
2. Select the required waveband by pressing the **FM/DAB Band** button.
3. Momentarily press the required **Preset button**, your radio will tune to the station stored in preset memory.



Note: If you have not previously stored a preset station and the preset button is pressed "preset N empty" will be displayed.



Classic FM DAB
Digital 1 Network

System reset

If your radio fails to operate correctly, or some digits on the display are missing or incomplete carry out the following procedure.

1. Press and hold in the **Info button** until the display shows CRD39 v1.03.
2. Press the **Info button** twice the display will show "Select to Reset".
3. Press in and release the **Select/Real time button** to select System reset.
4. If DAB was used last then a "Quick scan" of the DAB band will be performed, otherwise a "Quick scan" will be carried out the next time the DAB band is selected.

If a problem persists our technical staff would be pleased to help offer any assistance on operating the radio. Our technical helpline number is 020 8758 0338.

Info



```
Classic FM    DAB
CRD39        v1.03
```

Info



```
Classic FM    DAB
Select to Reset
```

Select/
Real Time



```
System Reset
```

```
Autotune
Quick scan
```

```
■■■■□□□□□□□□ 24
Searching9... 11C
```

```
■■■■■■■■■■ 24
Digital 1 Network
```

Classic FM button

Your radio is fitted with a button which when pressed will automatically tune your radio to Classic FM on the DAB waveband.

1. Press the **Classic FM button**.
2. Your radio will automatically tune to Classic FM.

Note: If Classic FM is not available in your area the display will show "Not Available". As an alternative it may be possible to listen to classic FM on the FM waveband.



Classic FM	DAB
Digital 1 Network	

Software version

The software display cannot be altered and is for your reference only.

1. To view the software version your radio has, press and hold in the **Info button**. The software version will appear on the display.



Classic FM	DAB
CRD39	v1.03

Sleep function

Your clock radio can be set to turn off after a preset time has elapsed.

1. Press the **Sleep button** the display will show "Sleep after 30 minutes".
2. Rotate the **Tuning control** to increase the time by 1 minute increments, up to a maximum of 99 minutes.
3. Rotating the **Tuning control** in the opposite direction will decrease the time by 1 minute increments.
4. Your radio will switch off after the preset sleep time has elapsed.
5. To cancel the sleep function before the preset time has elapsed, press the **On/Off button**.

Sleep



Sleep after...
30 minutes

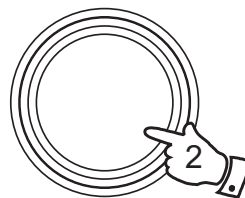

TUNING

Sleep after...
99 minutes



Alarm display

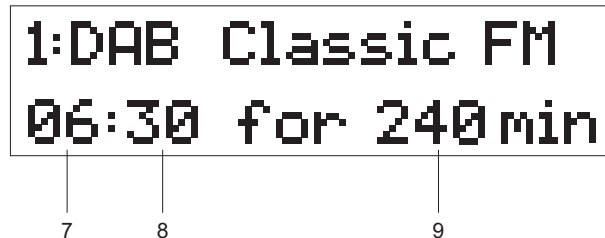
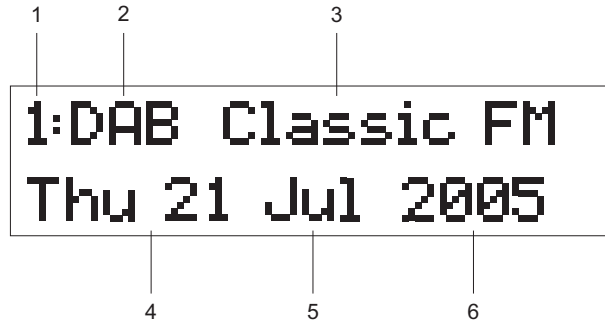

- | | |
|--|-----------------------------------|
| 1. Alarm/timer number indicator (1-5) | 5. Month indicator |
| 2. Alarm/timer mode indicator
DAB/FM/BUZZER | 6. Year indicator |
| 3. DAB - Station indicator
FM - Frequency indicator | 7. Alarm/timer hour indicator |
| 4. Day indicator | 8. Alarm/timer minute indicator |
| | 9. Alarm/timer duration indicator |

Alarms/timers

Your radio has five separate alarms/timers which can be set to activate at different times and six different day options from which to choose.

Your buzzer alarm has a humane wake system whereby the alarm starts at a low level and gradually works up to a high level.

1. Press and release the **Alarm button**, "alarm 1-5" will flash in the display.
2. Rotate the **Tuning control** to select the required alarm 1- 5.
3. Press and release the **Select/Real time button** to step forward to the alarm mode. The alarm mode indicator will flash in the display.
4. Rotate the **Tuning control** to select the required alarm mode. Select either DAB, FM or BUZZER.

DAB alarm mode

- If DAB alarm mode has been selected, press and release the **Select/Real time button** to step forward to select the DAB station name. The station name indicator will flash in the display.
- Rotate the **Tuning control** to select the required DAB station.

FM alarm mode

- If FM alarm mode has been selected, press and release the **Select/Real time button** to step forward to select the FM frequency. The frequency indicator will flash in the display.
- Rotate the **Tuning control** to select the required frequency.

Alarm



1:DAB Classic FM
Thu 21 Jul 2005

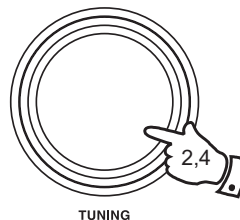

Select/ Real Time



1:BUZZ-
Thu 21 Jul 2005

1:DAB Classic FM
Thu 21 Jul 2005

1:FM 88.10MHz
Thu 21 Jul 2005

5. Press and release the **Select/Real time button** to enter the day. The day indicator will flash in the display.
6. Rotate the **Tuning controls** to select the required day.
7. Press and release the **Select/Real time button** to step forward to enter the month. The month indicator will flash in the display.
8. Rotate the **Tuning control** to select the required month.
9. Press and release the **Select/Real time button** to step forward to enter the year. The year indicator will flash in the display.
10. Rotate the **Tuning control** to select the required year.

Select/
Real Time



1:DAB Classic FM
Thu 21 Jul 2005

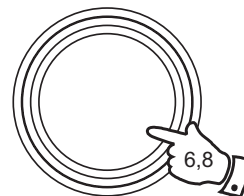

TUNING

1:DAB Classic FM
Thu 21 Jul 2005

Select/
Real Time



1:DAB Classic FM
Thu 21 Jul 2005

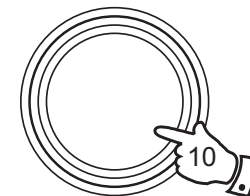

TUNING

11. Press and release the **Select/Real time button** to step forward to enter the alarm hour. The hour indicator will flash in the display.
12. Rotate the **Tuning control** to select the required hour.
13. Press and release the **Select/Real time button** to step forward to enter the alarm minute. The minute indicator will flash in the display.
14. Rotate the **Tuning control** to select the required minute.
15. Press and release the **Select/Real time button** to step forward to enter the alarm duration. The alarm duration indicator will flash in the display.
16. Rotate the **Tuning control** to select the required alarm duration. This can be set in 1 minute increments (maximum 240 minutes).

Select/
Real Time



1:DAB Classic FM
06:30 for 240 min

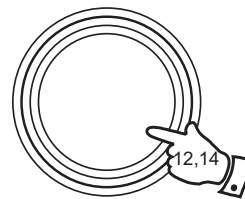

TUNING

Select/
Real Time



1:DAB Classic FM
06:30 for 240 min

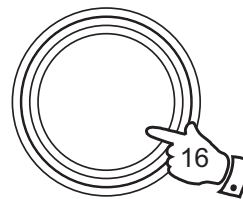

TUNING

1:DAB Classic FM
06:30 for 240 min

17. Press and release the **Select/Real time button** to step forward to enter the day option. The day option indicator will flash in the display.

18. Rotate the **Tuning control** to select the required alarm day option.

- Your alarm can be set to sound once, daily, weekly, weekends, weekdays or monthly.

Once - Will sound at one time only

Daily - Will sound every day

Weekly - Will sound once every week

Weekends - Will sound only on weekends

Weekdays - Will sound on a particular weekday

Monthly - Will sound every month

19. Press the **Select/Real time button** to confirm settings.

20. To exit the alarm setup and return to the normal radio mode press the **On/Off button** at any time during the setup process.

21. Press the **On/Off button** again and the radio will remain in standby mode until the alarm sounds. The alarm/timer symbol  will appear in the display.

The alarm will sound at the selected alarm time.

The radio alarm volume will be the volume previously listened to when setting up the alarms.

Select/
Real Time



1:DAB Classic FM
Once

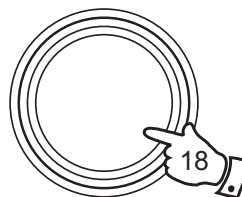

TUNING

1:DAB Classic FM
Daily

1:DAB Classic FM
Weekly

Select/
Real Time



1:DAB Classic FM
Weekends

1:DAB Classic FM
Weekdays



1:DAB Classic FM
Monthly

Snooze function

1. The radio or buzzer alarm can be silenced for 7 minutes by pressing and releasing the **Snooze button**. This sequence can be repeated during the alarm period. The snooze symbol  will appear on the display.
2. Press the **On/Off button** to cancel the snooze completely.



Cancelling alarms

Note: The alarm will activate for 60 minutes unless a specified alarm duration has been entered (maximum 240 minutes).

1. Press the **On/Off button** twice to switch the alarm off.
2. Enter the alarm setup menu and select the alarm mode to the "OFF" position.

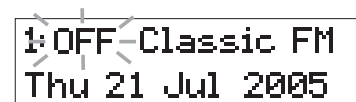

Auto Dimmer

The **Auto Dimmer** located on top of the right side of the LED display will automatically adjust the intensity of the clock display to suit room brightness.

Connecting to an external amplifier or recorder

You can connect your radio to an external amplifier or recorder. This may be a stand-alone unit or it may be part of your existing hi-fi system.

1. Connect the optical toslink connector to the optical input socket(s) on your amplifier or recorder using a suitable cable.

Recording from your radio

Your radio has five alarm/timers which can be set to switch on your radio at a preset day, time, and station. See section on page 21 for details on how to set alarm/timers

1. A programme/station can be recorded to an external device via the optical toslink connector located on the rear of your radio. Connect the optical toslink connector to the optical input socket(s) on your recorder using a suitable cable.

Most mini disc units have a record pause mode that enables the mini disc to start recording as soon as a signal appears on the mini disc input. When your radio switches on controlled by the alarm timer the mini disc will start recording.

Subsequent timer events are then recorded onto track 2,3, etc. Consult your hi-fi or mini disc user guide for further details. The volume on your radio can be set to 0 so that you will not be disturbed during the recording. The volume control does not affect the recording level.

Note: The timer record function is for personal use only.

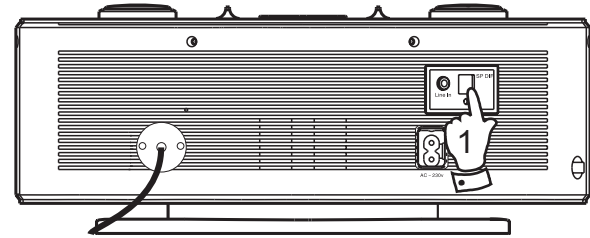

Clock display

1. Your radio will display clock time when it is set to Standby mode.
2. During Standby mode the clock will receive updates from the last station tuned to before entering Standby mode.

When in Standby mode your radio's clock will automatically track Summer/Winter time changes.

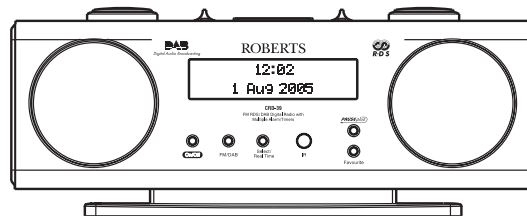

Display backlight

1. The display backlight will illuminate when your radio is switched on and dim to about one tenth of the full brightness when your radio is in standby mode.

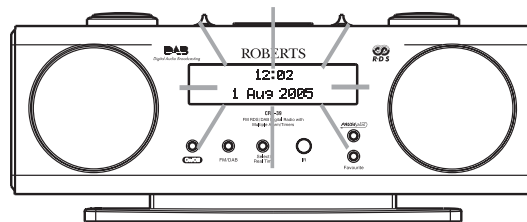

Headphone socket

1. A 3.5mm **Headphone Socket** located on the left hand side of your radio is provided for use with either headphones or an earpiece. Inserting a plug automatically mutes the internal loudspeaker.

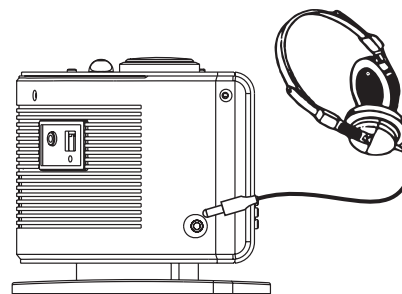

Line in socket (3.5mm Jack)

1. Connect a stereo or mono audio source (ie iPod, MP3 or CD player) to the **Line in socket**. Information from your radio's display will disappear - the backlight will be illuminated indicating that your radio is switched on.
2. Adjust the **Volume control** on your iPod, MP3 or CD player for comfortable listening.

The Alarm/Timers will not operate while you have any connection to the Line in socket.

Note: When you connect the audio source your radio will be muted. You must adjust the volume on your iPod, MP3 or CD player in order to play the sound through your radio speakers.

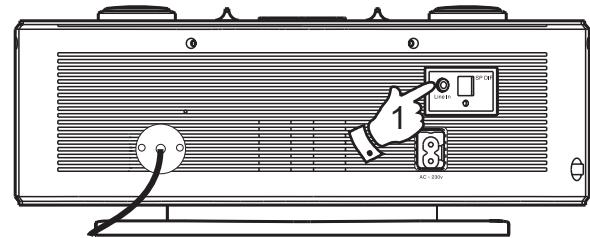

Optical output socket

1. A digital optical output socket is provided on the rear of your radio for connection to an amplifier, mini-disc or other equipment with a digital optical input.

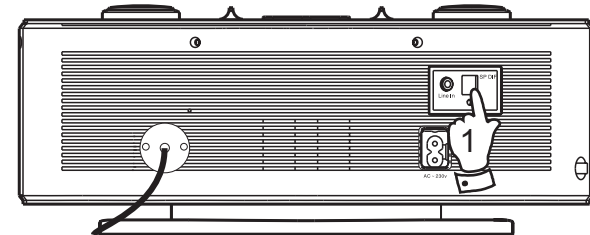

Remote control

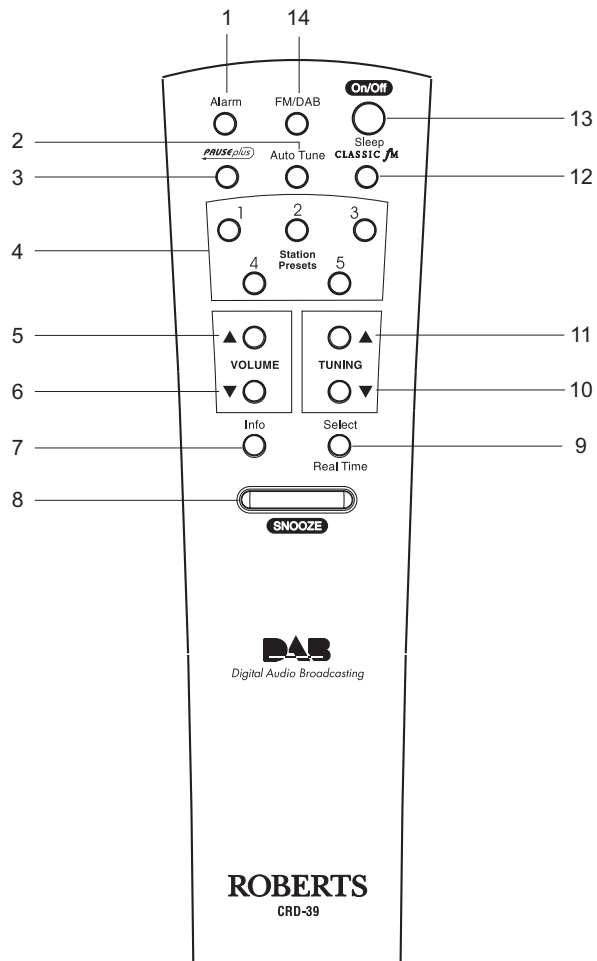

1. Alarm button
2. Auto Tune button
3. **PAUSEplus** button
4. Preset buttons
5. Volume Up button
6. Volume Down button
7. Info button
8. Snooze button

9. Select/Real time button
10. Tuning Down button
11. Tuning Up button
12. Classic FM button
13. On/Off/Sleep button
14. FM/DAB button

Remote handset battery replacement

1. Remove the battery cover on the rear of your remote control by pushing the battery door in and downwards.
2. Insert 2 x AAA size batteries into the compartment. Make sure the (+) and the (-) ends of the batteries are positioned as shown inside the compartment.
3. Close the battery cover.
4. If the remote is not to be used for an extended period of time it is recommended that the batteries are removed.



Using the remote control

The buttons on the remote control have the same functions as the front and top panel controls with the following exceptions:-

Tuning Up/down buttons and Volume Up/Down buttons instead of the rotary control.

The sleep function can be operated by using the On/Off button. Press and hold the **On/Off/Sleep button** until the sleep options appear on the display.

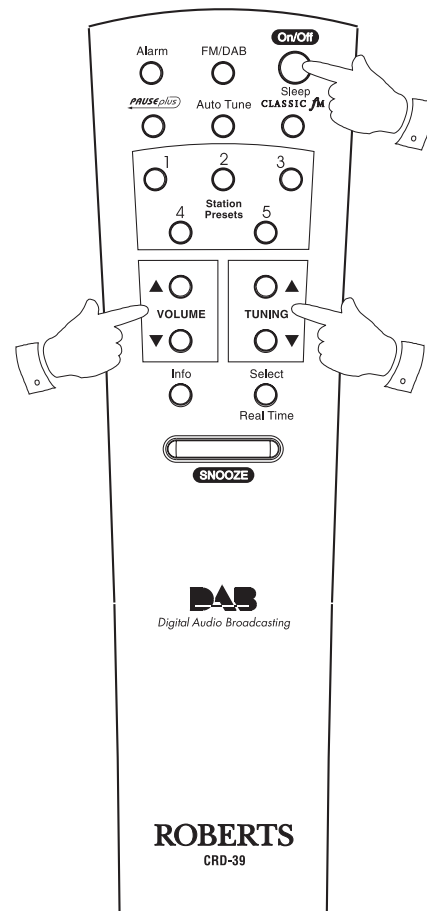

General

Do not allow this radio to be exposed to water, steam or sand. Do not leave your radio where excessive heat could cause damage. It is recommended that the DAB band be used wherever possible as better results in terms of quality and freedom from interference will usually be obtained than on the FM band.

- The name plate is located on the bottom panel.

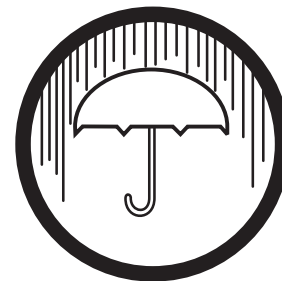
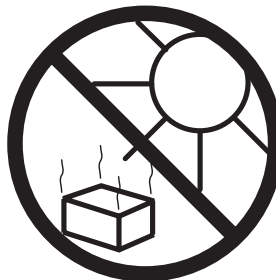

Specifications

Power Requirements

Mains	AC 230 volts, 50Hz  only
Battery (Remote control)	2 x AAA size

Frequency Coverage

FM	87.5-108MHz
DAB	174.928 - 239.200MHz

Circuit Features

Loudspeaker	2 x 76 mm
Output Power	3W into 4 ohms
Headphone socket	3.5mm dia
Line in socket	3.5mm dia
Digital optical output socket	

Aerial System	FM	Wire aerial
	DAB	Wire aerial

Mains supply

The CRD39 will operate from a supply of AC 230 volts, 50Hz \sim only.

DO NOT cut off the mains plug from this equipment. If the plug fitted is not suitable for the power points in your home or the cable is too short to reach a power point, then obtain an appropriate safety approved extension lead or adaptor. If in doubt consult your dealer.

If nonetheless the mains plug is cut off, remove the fuse and dispose of the plug immediately to avoid a possible shock hazard by inadvertent connection to the mains supply.

If this product is not supplied with a mains plug, or one has to be fitted, then follow the instructions given below:

IMPORTANT. DO NOT make any connection to the larger terminal which is marked with the letter E or by the safety earth symbol \perp or coloured Green or Green-and-yellow.

The wires in the mains lead are coloured in accordance with the following codes :-

BLUE - NEUTRAL

BROWN - LIVE

The wire coloured BLUE must be connected to the terminal marked N or coloured BLACK.

The wire coloured BROWN must be connected to the terminal marked L or coloured RED.

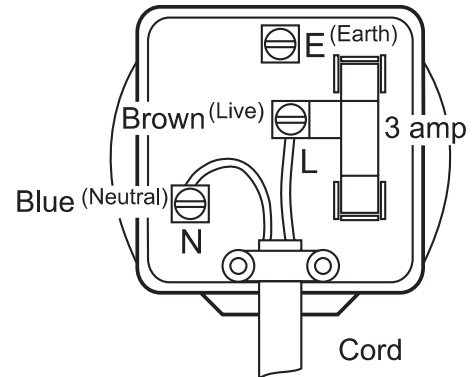

Fuse

When replacing the fuse only a 3A ASTA approved to BS1362 type should be used and be sure to re-fit the fuse cover.

IF IN DOUBT - CONSULT A QUALIFIED ELECTRICIAN.

Replacement fuse holders are available from Roberts Radio Technical Services at the address shown on the rear of this manual.

Guarantee

This instrument is guaranteed for twelve months from the date of delivery to the original owner against failure due to faulty workmanship or component breakdown, subject to the procedure stated below. Should any component or part fail during this guarantee period it will be repaired or replaced free of charge.

The guarantee does not cover:

1. Damage resulting from incorrect use.
2. Consequential damage.
3. Receivers with removed or defaced serial numbers.

N.B. Damaged or broken telescopic aerials will not be replaced under guarantee.

Procedure:

Any claim under this guarantee should be made through the dealer from whom the instrument was purchased. It is likely that your Roberts' dealer will be able to attend to any defect quickly and efficiently but should it be necessary the dealer will return the instrument to the Company's service department for attention. In the event that it is not possible to return the instrument to the Roberts' dealer from whom it was purchased, please contact Roberts Radio Technical Services at the address shown overleaf.



Issue 1

ROBERTS RADIO TECHNICAL SERVICES

97-99 Worton Road

Isleworth Middlesex

TW7 6EG

Technical Helpline :- 020 8758 0338 (Mon-Fri during office hours)

Website: <http://www.robertsradio.co.uk>

