

# ROBERTS

Sound for Generations



# CR9936

Dual Alarm CD Clock Radio  
With Night Light

*PISA*  
*four*

Please read this manual before use

## Contents

<i>Contents</i> .....	1	<i>Setting alarms to wake to CD</i> .....	16
<i>Controls</i> .....	2-3	<i>Setting alarms to wake to CD programme</i> .....	17
<i>Switching on and setting the time</i> .....	4	<i>Snooze control</i> .....	18
<i>Listening to the radio</i> .....	5	<i>Sleep function</i> .....	18
<i>Compact discs</i> .....	6	<i>Auto dimmer</i> .....	19
<i>CD-R/CD-RW discs</i> .....	6	<i>Night light</i> .....	19
<i>Inserting a CD</i> .....	7	<i>Headphones</i> .....	19
<i>Playing a CD</i> .....	8	<i>Specifications</i> .....	20
<i>Selecting a track</i> .....	9	<i>Circuit features</i> .....	20
<i>Search function</i> .....	9	<i>General</i> .....	21
<i>CD repeat mode</i> .....	10	<i>Guarantee</i> .....	22
<i>CD random play</i> .....	10		
<i>Warning</i> .....	10		
<i>Programmed play</i> .....	11		
<i>Checking a programme</i> .....	11		
<i>Erasing a programme</i> .....	11		
<i>Setting alarm times</i> .....	12		
<i>Setting alarm 1</i> .....	12		
<i>Setting alarm 2</i> .....	12		
<i>Checking alarm times</i> .....	13		
<i>Setting alarms to wake to buzzer</i> .....	14		
<i>Setting alarms to wake to radio</i> .....	15		

## Controls

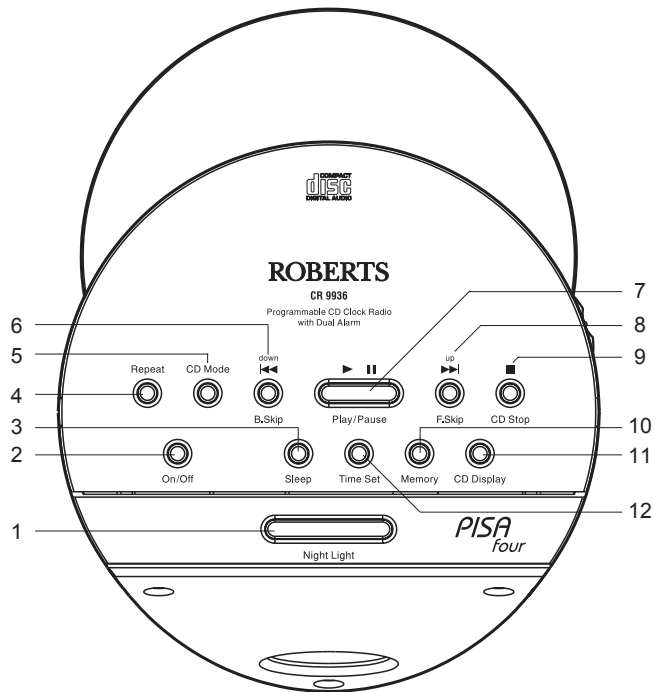

- |                       |                       |                       |
|-----------------------|-----------------------|-----------------------|
| 1. Night Light button | 6. B.Skip/down button | 11. CD display button |
| 2. On/Off button      | 7. Play/Pause button  | 12. Time set button   |
| 3. Sleep button       | 8. F.Skip/up button   | 13. Snooze button     |
| 4. Repeat button      | 9. CD Stop button     | 14. Alarm 1 indicator |
| 5. CD mode button     | 10. Memory button     | 15. PM indicator      |

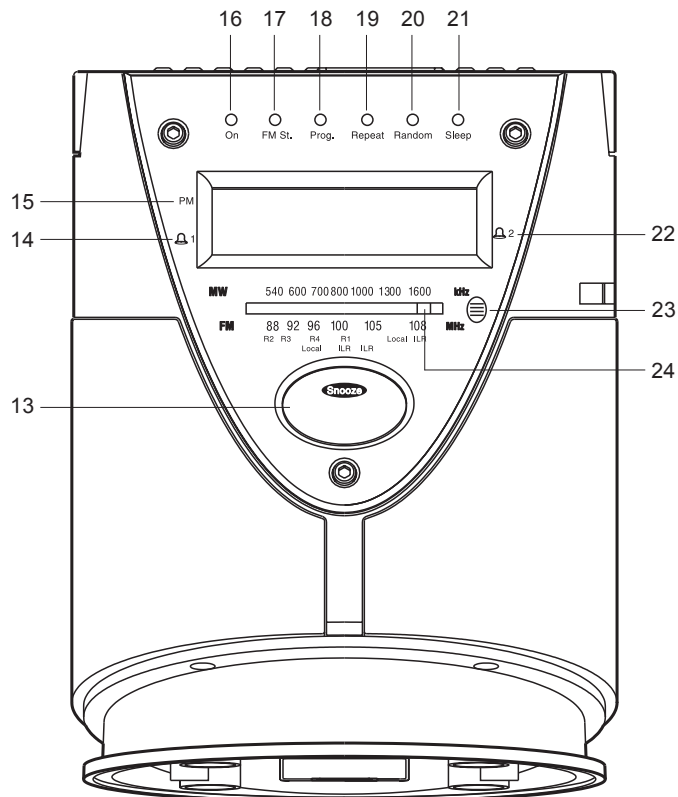

- |                         |                       |
|-------------------------|-----------------------|
| 16. On indicator        | 21. Sleep indicator   |
| 17. FM stereo indicator | 22. Alarm 2 indicator |
| 18. Programme indicator | 23. Auto dimmer       |
| 19. Repeat indicator    | 24. Dial pointer      |
| 20. Random indicator    |                       |

## Controls

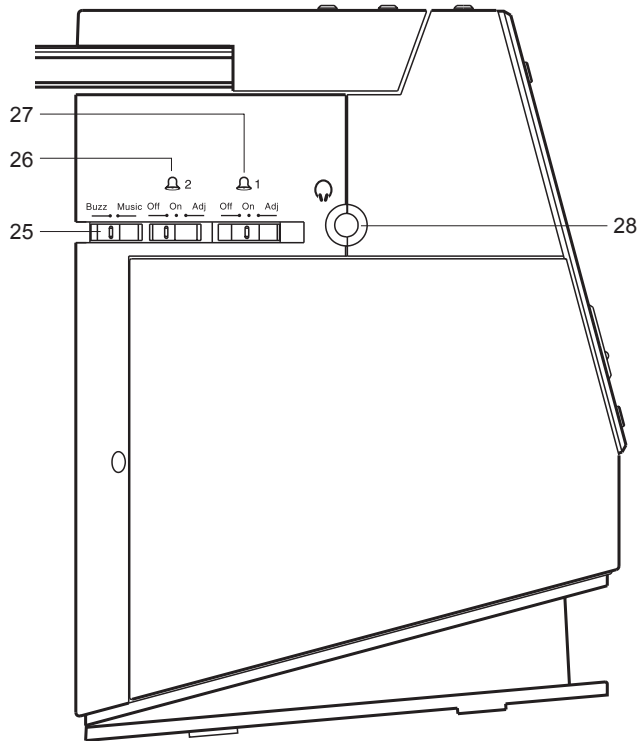

- 25. Buzz/Music switch
- 26. Alarm 2 function switch
- 27. Alarm 1 function switch
- 28. Headphone socket
- 29. Night Light

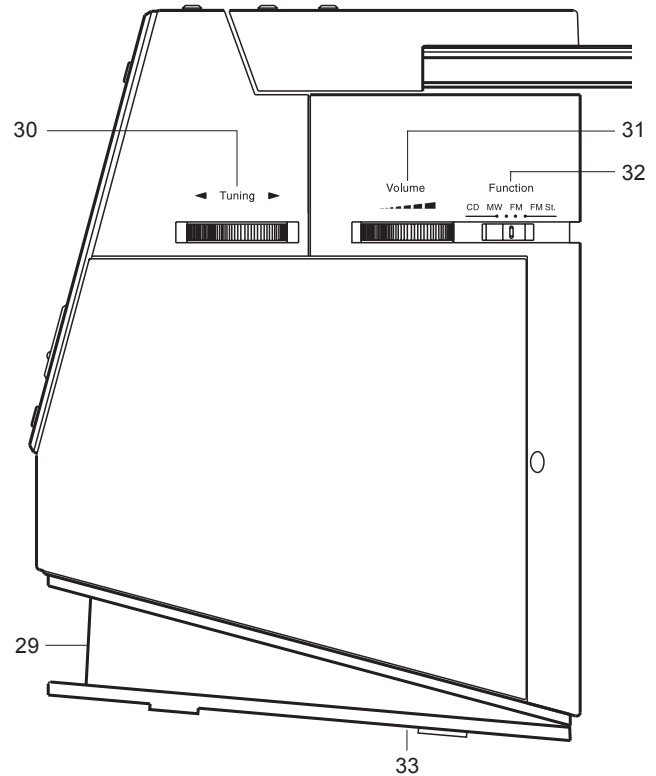

- 30. Tuning control
- 31. Volume control
- 32. Function switch
- 33. Battery compartment (on underside)

## Switching on and setting the time

Before using your CD clock radio you must first set the correct time.

1. Place the unit on a flat surface. Plug the mains lead into a wall socket and switch on the wall socket.
2. The clock display will show 12:00. Ensure that the **Alarm 1** and **Alarm 2 function switches** are set to the 'Off' position.
3. Press and hold down the **Time Set button**. The time will flash in the display.
4. Whilst holding down the **Time Set button** press the **up button** to set the hour and the **down button** to set the minutes. Release the buttons when the correct time is reached. The clock uses a 12 hour display with a **PM indicator**. Ensure that the correct 12 hour cycle is selected.

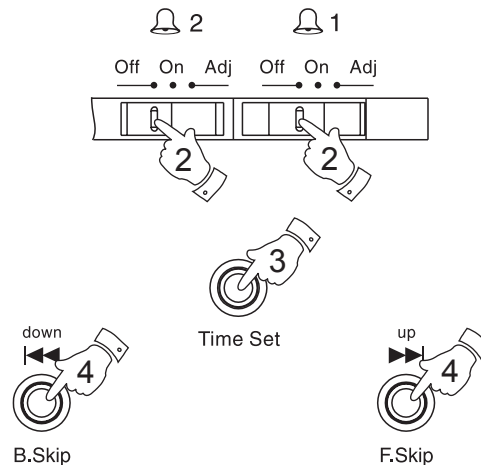
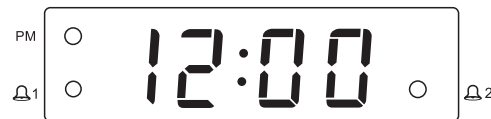
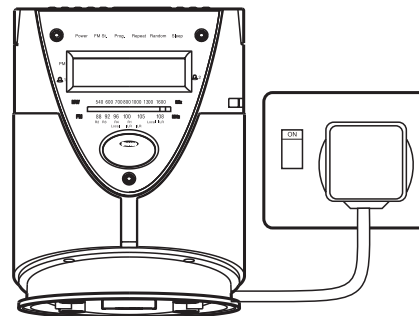

If you need any further advice, please call our Technical Helpline on :-  
020 8758 0338 (Mon-Fri)

## Listening to the Radio

1. Switch on your CD clock radio by pressing the **On/Off button**. The **On indicator** LED will light.



On/Off

2. Slide the **Function switch** to the required waveband.

Function

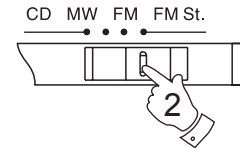

3. Tune in to the desired station by rotating the **Tuning control**. The station frequency is indicated in the dial scale.

The **Wire aerial** located on the rear of your CD clock radio is for FM reception. The wire should be fully extended and positioned for optimum reception.

For MW reception there is a built in ferrite aerial. Rotate your CD clock radio to the position giving best reception.

◀ Tuning ▶

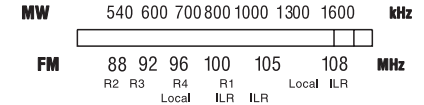
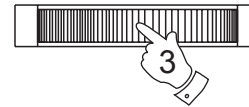

Volume

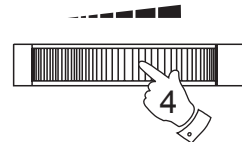

Function

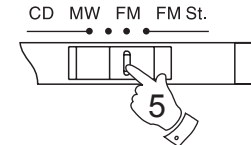

6. The radio can be switched off by pressing the **On/Off button**. The **On indicator** will switch off.



On/Off

## Compact discs

Use only Digital Audio CDs which have the



symbol.

Never write on a CD or attach any sticker to the CD. Always hold the CD at the edge and store it in its box after use with the label facing up.

To remove dust and dirt, breathe on the CD and wipe it with a soft, lint-free cloth in a straight line from the centre towards the edge.

Cleaning agents may damage the CD

Do not expose the CD to rain, moisture, sand, or to excessive heat. (e.g. from heating equipment or in motor cars parked in the sun).

## CD-R/CD-RW discs

Your CD clock radio can playback CD-DA format audio CD-R/CD-RW discs that have been finalised\* upon completion of recording.

Your CD clock radio may fail to playback some CD-R/CD-RW discs due to poor recording of the CD-R/CD-RW disc.

*\*Finalising enables a CD-R/CD-RW disc to playback on audio CD players such as your CD clock radio.*

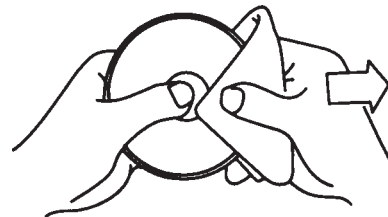

## Inserting a CD

1. Press the **On/Off button** to switch on your CD clock radio. The **On indicator** will light.
2. Set the **Function switch** to CD.
3. To open the CD compartment, lift the **CD door** on the rear edge as shown.
4. Press the CD onto the spindle until it clicks into place. Close the CD door. The CD player will scan the contents of the CD and the total number of tracks will appear on the display.



On/Off

Function

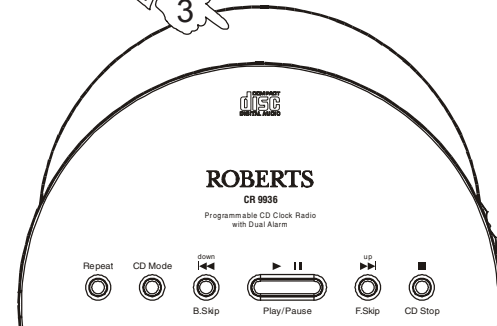
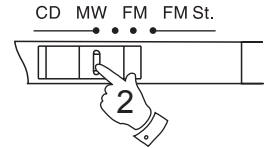



## Playing a CD

1. Press the **Play/Pause button** to start playback. The display will show the track number. After a short time the display will revert to showing time.
2. Set the **Volume control** to the required setting.
3. To display the CD track number press the **CD display button**.
4. To pause playback press the **Play/Pause button**. The track number will flash in the display. To resume playback press the **Play/Pause button** again.
5. To stop playback, press the **CD Stop button**.
6. To take out the CD, lift the CD door on the rear edge and remove CD from the spindle. The CD door should only be opened when the CD is in Stop mode.

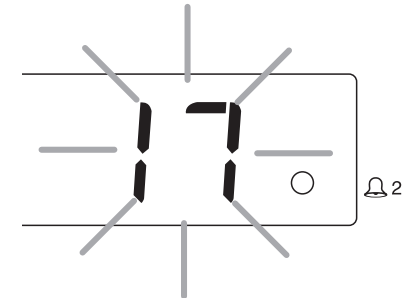
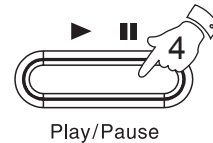
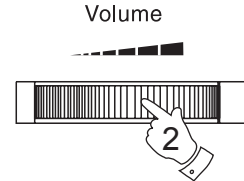
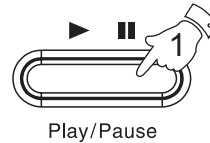

If you need any further advice, please call our Technical Helpline on :-  
020 8758 0338 (Mon-Fri)

## Selecting a track

1. Whilst the CD is playing, press either the **F.skip** or **B.skip buttons** to change to the desired track. You can also skip tracks when the player is in stop mode. Skip to the desired track using the **F.skip** or **B.skip buttons**.
2. Press the **Play/Pause button** to play the selected track.

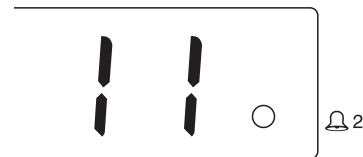

---

## Search function

1. Whilst the CD is playing, press and hold down either the **F.skip** or **B.skip buttons**. Release the button when the desired part of the track is reached.



## CD repeat mode

1. Whilst the CD is playing press the **Repeat button** once to repeat the current track. The **Repeat indicator** will flash.
2. Press the **Repeat button** again to repeat all tracks on the CD. The **Repeat indicator** will light up.
3. Press the **Repeat button** again to return to normal play. The **Repeat indicator** will switch off.

Repeat



## CD Random play

1. Press the **CD Mode button** to play all tracks on the CD in random order. The **Random indicator** will light up. The tracks are played in random order until all tracks have been played.
2. Press the **CD Mode button** again to return to normal play. The **Random indicator** will switch off.

CD Mode



## Warning

**CLASS 1 LASER PRODUCT** means that the laser's construction makes it inherently safe so that the legally prescribed maximum permissible radiation values can never be exceeded

**Caution:** Using any equipment or devices other than those described and specified in these operating instructions, or tampering with the unit in any way, can result in dangerous exposure to radiation.

*If you need any further advice, please call our Technical Helpline on :-  
020 8758 0338 (Mon-Fri)*

**CLASS 1  
LASER PRODUCT**

## Programmed play

By programming the player you can play up to 20 tracks in any desired order.

1. Whilst the CD is in STOP mode, press the **Memory button**. The display will show 'P 01'.

Note: the display will revert to showing time after 10 seconds of inactivity.

2. Select the first track using the **F.skip** or **B.skip** buttons. The track number will flash on the display. Store this track by pressing the **Memory button**.

3. Repeat the above steps until you have completed your program (maximum 20 tracks). Press the **Play/Pause** button to commence play of the selected tracks.

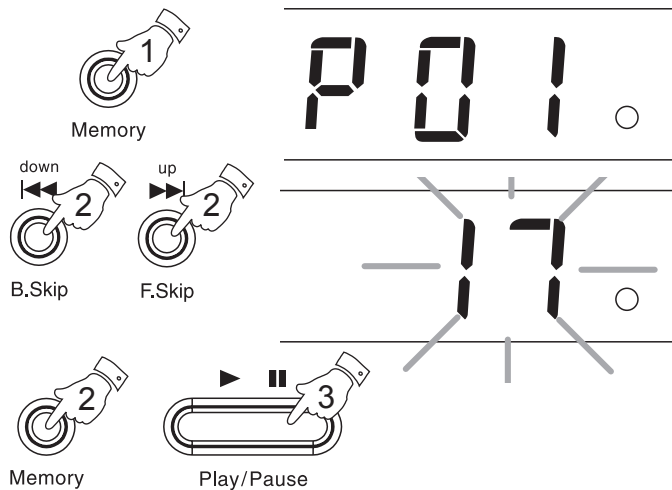

## Checking a programme

1. Whilst the CD is in STOP mode, repeatedly press the **Memory button** to step through the tracks programmed.

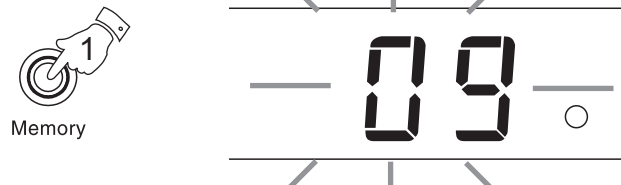

## Erasing a programme

1. Whilst the CD is in STOP mode, press the **Memory button**. The **Prog. indicator** will flash.
2. Press the **CD Stop button** to erase the programme. Programmes are also erased by opening the **CD door**, changing position of the **Function switch** and interrupting the mains supply.

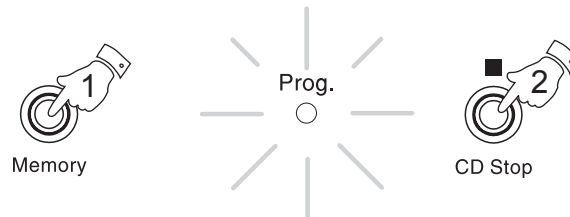

## Setting alarm times

The alarms can be set to wake you by a buzzer, CD or the radio. Your CD clock radio has 2 separate alarms which can be set to activate at different times.

### Setting alarm 1

1. Slide the **Alarm 1 function switch** to the 'Adj' position. Alarm 1 time will flash in the display.
2. Press the **down button** to set minutes and the **up button** to set the hour. Release the buttons when the correct time is reached. Alarm 1 time will continue to flash in the display. The clock uses a 12 hour display with a **PM indicator**. Ensure that the correct 12 hour cycle is selected.
3. Return the **Alarm 1 function switch** to the 'Off' position. The display will revert to showing time.

Note: Incorrect display will result if both the Alarm function switches are set to the 'Adj' position.

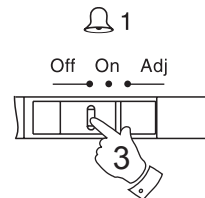
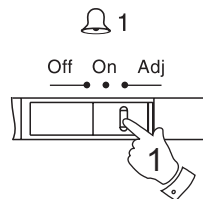

### Setting alarm 2

1. Slide the **Alarm 2 function switch** to the 'Adj' position. Alarm 2 time will flash in the display.
2. Press the **down button** to set minutes and the **up button** to set the hour. Release the buttons when the correct time is reached. Alarm 2 time will continue to flash in the display. The clock uses a 12 hour display with a **PM indicator**. Ensure that the correct 12 hour cycle is selected.
3. Return the **Alarm 2 function switch** to the 'Off' position. The display will revert to showing time.

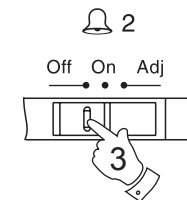
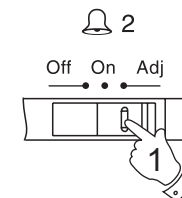

If you need any further advice, please call our Technical Helpline on :-  
020 8758 0338 (Mon-Fri)

## Checking the Alarm Times

1. To check alarm 1 time, set the **Alarm 1 function switch** to the 'Adj' position. Alarm 1 time will flash in the display.
2. Return the **Alarm 1 function switch** to the 'Off' position. The display will revert to showing time.
3. To check Alarm 2 time, set the **Alarm 2 function switch** to the 'Adj' position. Alarm 2 time will flash in the display.
4. Return the **Alarm 2 function switch** to the 'Off' position. The display will revert to showing time.

Note: Incorrect display will result if both the Alarm function switches are set to the 'Adj' position.

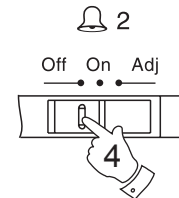
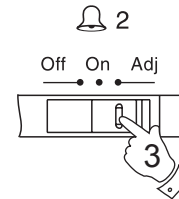
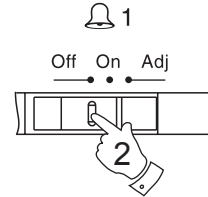
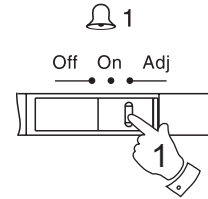

## Setting the alarms to wake to buzzer

1. Set the alarm time as previously described. Set the **Alarm mode switch** to the 'Buzz' position.
  2. Set the **Alarm 1 or Alarm 2 function switch** to the 'On' position. The corresponding **Alarm indicator** will light.
  3. Press the **On/Off button** to switch off your CD clock radio, the **On indicator** will switch off.
  4. The buzzer alarm will sound every day at the preset time for 90 minutes. To switch off the alarm until the next day press the **On/Off button**.
  5. To switch off the alarms permanently set the **Alarm 1 or Alarm 2 function switch** to the 'Off' position.
- Note: Alarm 1 has a low tone Alarm 2 has a high tone.

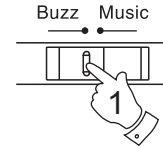

Off On Adj

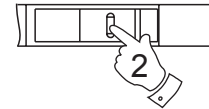

On/Off



On/Off



Off On Adj

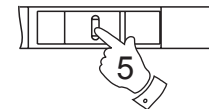

## Setting the alarms to wake to radio

1. Set the alarm time as previously described. Set the **Alarm function switch** to the 'Music' position.
2. Set the **Alarm 1** or **Alarm 2 selector switch** to the 'On' position. The corresponding **Alarm indicator** will light.
3. Select the required waveband and ensure that a station is tuned in.
4. Set the **Volume control** to the desired level.
5. Press the **On/Off button** to switch off your CD clock radio, the **On indicator** will switch off.
6. The radio alarm will sound every day at the preset time for 90 minutes. To switch off the alarm until the next day press the **On/Off button**.
7. To switch off the alarms permanently set the **Alarm 1 or Alarm 2 function switch** to the 'Off' position.

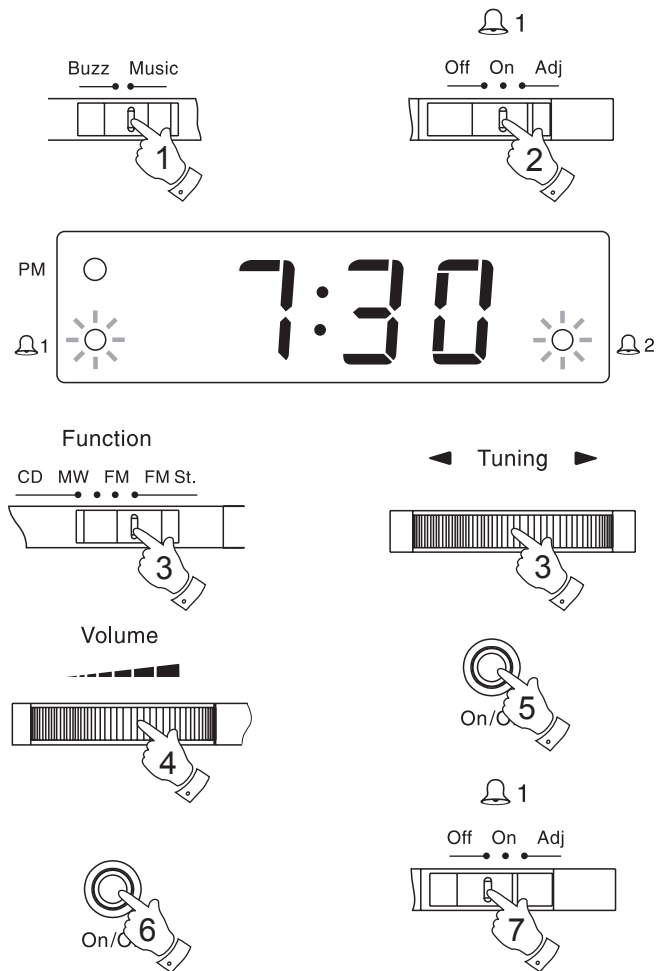



## Setting the alarms to wake to CD

1. Set the alarm time as previously described. Set the **Alarm function switch** to the 'Music' position.
2. Set the **Alarm 1** or **Alarm 2 selector switch** to the 'On' position. The corresponding **Alarm indicator** will light.
3. Set the **Function switch** to the 'CD' position, insert a CD and ensure that the **Volume control** is set to the desired level.
4. Press the **On/Off button** to switch off your CD clock radio, the **On indicator** will switch off. **Important: failure to switch off the unit will result in non operation of the CD at alarm time.**
5. The CD will play every day at the preset time for a maximum of 90 minutes. To switch off the alarm until the next day press the **On/Off button**.
6. To switch off the alarms permanently set the **Alarm 1 or Alarm 2 function switch** to the 'Off' position.

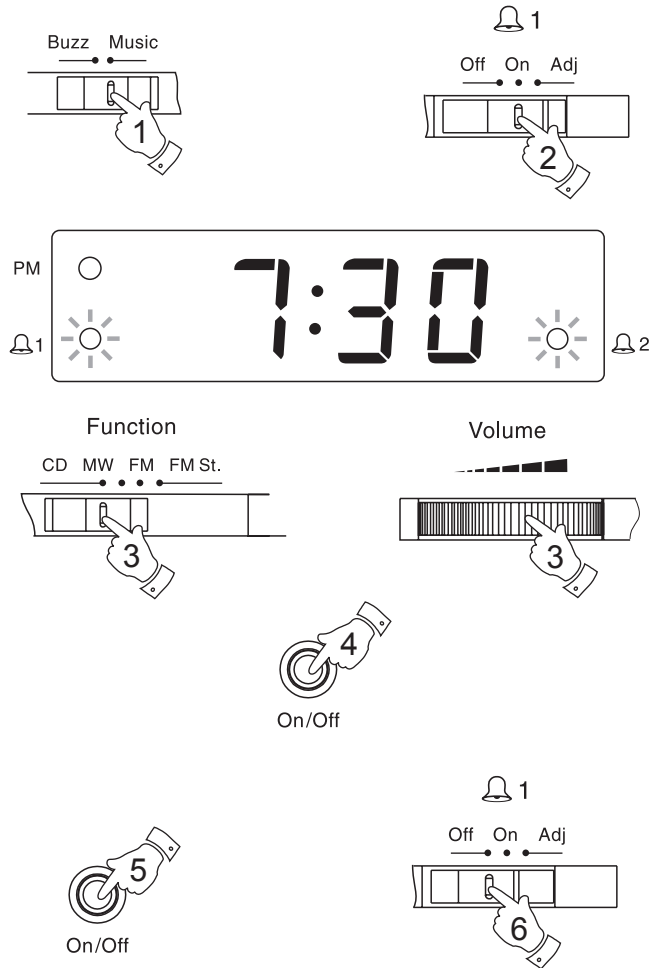

If you need any further advice, please call our Technical Helpline on :-  
020 8758 0338 (Mon-Fri)

## Setting the alarm to wake to CD programme

1. Set the alarm to wake to CD as previously described.
2. Programme your favourite tracks as described earlier.
3. Press the **Play button** followed by the **CD Stop button**.
4. Press the **On/Off button** to switch off your CD clock radio, the **On indicator** will switch off. **Important: failure to switch off the unit will result in non operation of the alarm.**
5. The CD will switch on at the preset time and play tracks in the order programmed.



Play/Pause



CD Stop



On/Off

## Snooze control

1. The buzzer, CD or radio alarm can be silenced for 6 minutes by pressing the **Snooze** button. This sequence can be repeated during the 90 minute alarm period.

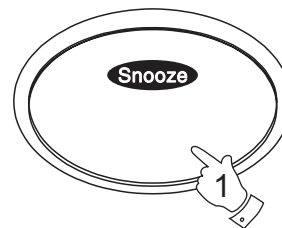

## Sleep timer

1. CD or radio playback can be set to switch off automatically after a preset time has elapsed.
2. Repeatedly press and release the **Sleep** button until the desired time is reached (maximum 90 minutes in 30 minute steps). The **Sleep indicator** will light up and after a few seconds the radio if selected will play. If CD has been selected press **Play button** and CD will play for the time selected sleep time.
3. The CD or radio will switch off after the sleep time has elapsed.
4. To cancel the sleep function before the preset time has expired, press the **On/Off button**.



Sleep



On/Off

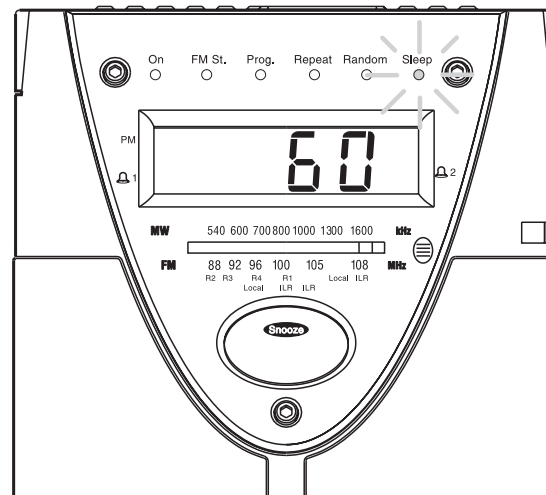

If you need any further advice, please call our Technical Helpline on :-  
020 8758 0338 (Mon-Fri)

## Auto Dimmer

1. The **Auto Dimmer** located on the right side of the tuning dial will automatically adjust the intensity of the clock display to suit room brightness.

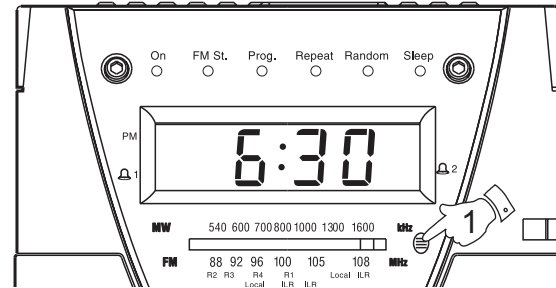

## Night light

1. Press the **Night Light** button to adjust level of night light, press once for dim light press once again for bright light and once again to switch off.

The night light located around the base of your CD clock radio will provide a warm glow adequate to allow you to move safely around the room.

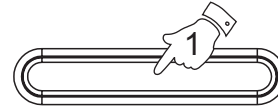

Night Light

## Headphones

1. A **Headphone Socket** (3.5mm) located on left side is provided for use with either headphones or an earpiece. Inserting a plug automatically mutes the internal loudspeaker.

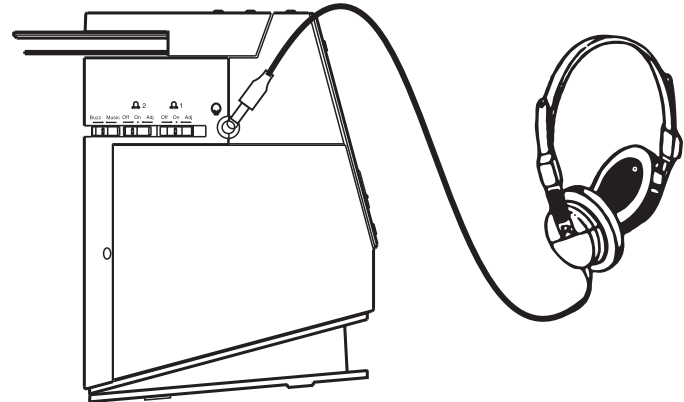

## Specifications

### Power Requirements

Mains	AC 230 volts, 50Hz $\sim$ only
Back-up Battery	IEC size 6LR61 (6F22, PP3)

### Frequency Coverage

FM	87.5 - 108MHz
MW	520 - 1610kHz

## Circuit Features

Loudspeakers	2 x 8 ohms
	Output power 2 x 1.5 Watts
Aerial System	FM Wire Aerial
	MW Built-in Ferrite aerial

**CLASS 1  
LASER PRODUCT**

## Warning

**CLASS 1 LASER PRODUCT** means that the laser's construction makes it inherently safe so that the legally prescribed maximum permissible radiation values can never be exceeded

**Caution:** Using any equipment or devices other than those described and specified in these operating instructions, or tampering with the unit in any way, can result in dangerous exposure to radiation.

*The Company reserves the right to amend the specification without notice.*

*If you need any further advice, please call our Technical Helpline on :-  
020 8758 0338 (Mon-Fri)*

## General

Do not allow this unit to be exposed to moisture (e.g. dripping or splashing) or to temperatures exceeding 70 degrees centigrade. It is recommended that the FM band be used wherever possible as better results in terms of quality and freedom from interference will usually be obtained than on the MW band.

## Mains supply

The CR9936 will operate from a supply of AC 230volts, 50Hz  $\sim$  only. For your convenience this product is supplied with a plug which is fitted with a fuse of the appropriate rating. If the plug supplied is not suitable for your socket outlet, it should be removed by unscrewing the plug top, the terminal screws and removing the cable.

The correct style of plug to suit your household together with a correctly rated fuse should be fitted.

IF IN DOUBT - CONSULT A QUALIFIED ELECTRICIAN

**IMPORTANT. DO NOT** make any connection to the larger terminal which is marked with the letter E or by the safety earth symbol  $\perp$  or coloured Green or Green-and-yellow.

The wires in the mains lead are coloured in accordance with the following codes :-

BLUE - NEUTRAL

BROWN - LIVE

As these colours may not correspond with the coloured markings identifying the terminals in your plug, proceed as follows:-

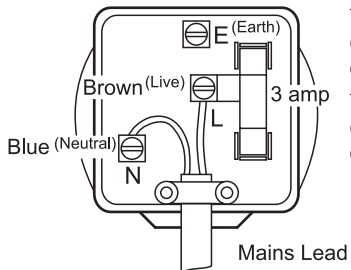

The wire coloured BLUE must be connected to the terminal marked N or coloured BLACK.

The wire coloured BROWN must be connected to the terminal marked L or coloured RED.

## Fuse

This apparatus must be protected by a 3A fuse (BS1362) in a 13A plug (BS1363). If another type of plug is used a 5A fuse should be fitted in the plug, adaptor or distribution board.

IF IN DOUBT - CONSULT A QUALIFIED ELECTRICIAN.

## Back-up Battery (not necessary for the unit to function)

Slide the battery cover catch in the direction of the arrow. Open the battery cover. Fit a 9 volt IEC size 6LR61 (6F22, PP3) or equivalent battery into the compartment. Observe the correct polarity as shown on battery cover.

The time and alarm settings will be retained during a temporary failure of the AC mains supply. The LED display will not be operational. The display will be extinguished to conserve battery life, but the memory will retain details of the time and alarm time settings.

If your clock radio is not to be used for a prolonged period of time, remove the battery to avoid damage by battery leakage.

## (Underside)

The Nameplate is located on the underside of your CD clock radio.

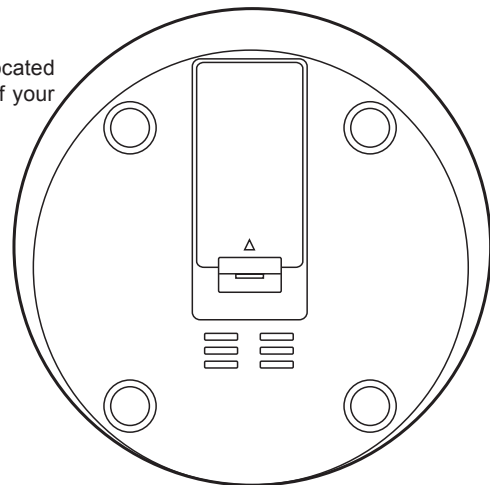

## Guarantee

This instrument is guaranteed for twelve months from the date of delivery to the original owner against failure due to faulty workmanship or component breakdown, subject to the procedure stated below. Should any component or part fail during this guarantee period it will be repaired or replaced free of charge.

The guarantee does not cover:

1. Damage resulting from incorrect use.
2. Consequential damage.
3. Receivers with removed or defaced serial numbers.

Procedure:

Any claim under this guarantee should be made through the dealer from whom the instrument was purchased. It is likely that your Roberts' dealer will be able to attend to any defect quickly and efficiently, but should it be necessary the dealer will return the instrument to the company's service department for attention. In the event that it is not possible to return the instrument to the Roberts' dealer from whom it was purchased, please contact Roberts Radio Technical Services department at the address shown the rear of this manual before taking further action.

*These statements do not affect the statutory rights of a consumer.*

## **ROBERTS RADIO TECHNICAL SERVICES**

97-99 Worton Road  
Isleworth Middlesex  
TW7 6EG

