

ROBERTS

Blutune 40

DAB / DAB+ / FM Bluetooth digital radio



DAB
Digital Audio Broadcasting

DAB+

+ Digital
Radio

 **Bluetooth™**

Please read this manual before use

Contents

<i>Controls</i>	2-3	<i>When the alarm sounds</i>	26
<i>Using the radio for the first time</i>	4	<i>Cancelling alarms</i>	26
<i>Operating your radio</i>	5	<i>Snooze function</i>	27
<i>Selecting a station - DAB</i>	6	<i>To view the alarm settings</i>	27
<i>Secondary services - DAB</i>	7	<i>Sleep function</i>	28
<i>Display options - DAB</i>	7-8	<i>Setting the clock format</i>	29
<i>Finding new stations - DAB</i>	9	<i>Setting the clock manually</i>	30-31
<i>Manual tuning - DAB</i>	10	<i>Automatically updating the clock</i>	32
<i>Dynamic Range Control (DRC) - DAB</i>	11	<i>Clock display</i>	33
<i>Prune stations - DAB</i>	12	<i>Display backlight dimmer</i>	33
<i>Operating your radio - FM auto-tune</i>	13	<i>Software version</i>	34
<i>Manual tuning - FM</i>	14	<i>Language function</i>	35
<i>Display options - FM</i>	15	<i>System reset</i>	36
<i>Scan sensitivity setting - FM</i>	16	<i>Headphone socket</i>	37
<i>Presetting stations</i>	17	<i>Auxiliary input socket</i>	37
<i>Recalling a preset station</i>	18	<i>USB socket for iPhone or smart phone charging</i>	38
<i>Bluetooth mode</i>	19-22	<i>Software upgrades</i>	39
<i>Connecting Bluetooth devices</i>	20	<i>Cautions</i>	40
<i>Playing audio files in Bluetooth mode</i>	21	<i>Specifications</i>	41
<i>Disconnecting a Bluetooth device</i>	22	<i>Circuit features</i>	41
<i>Setting alarm times</i>	23-25	<i>Guarantee</i>	42

Controls (Top)

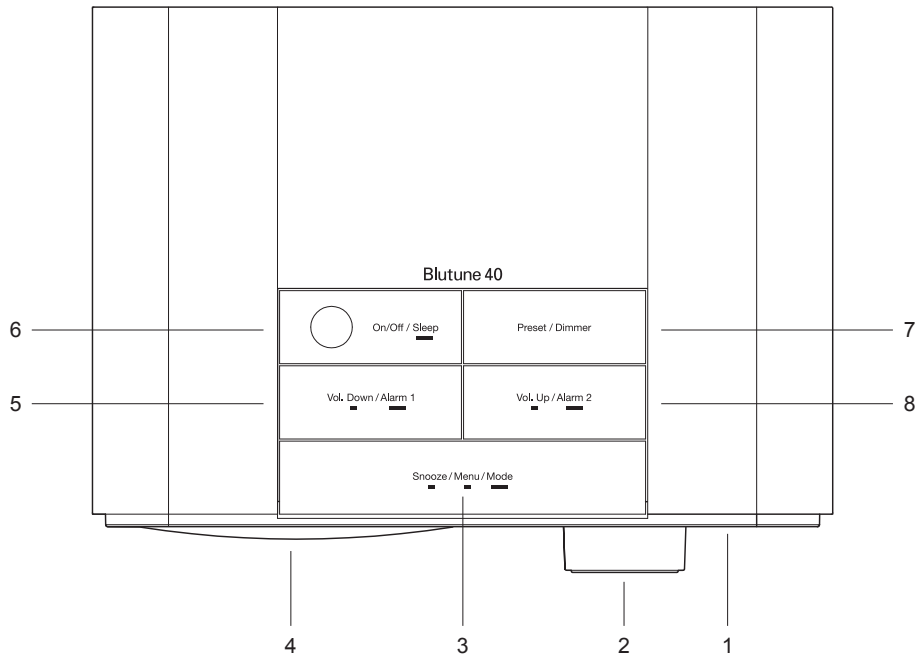

1. LCD display
2. Tuning / Select / Info control
3. Menu / Mode / Snooze button
4. Loudspeaker
5. Volume Down / Alarm 1 button
6. On/Off / Sleep button
7. Preset / Dimmer button
8. Volume Up / Alarm 2 button

Button operation

- Short press
- ▬ Long press

Controls (rear)

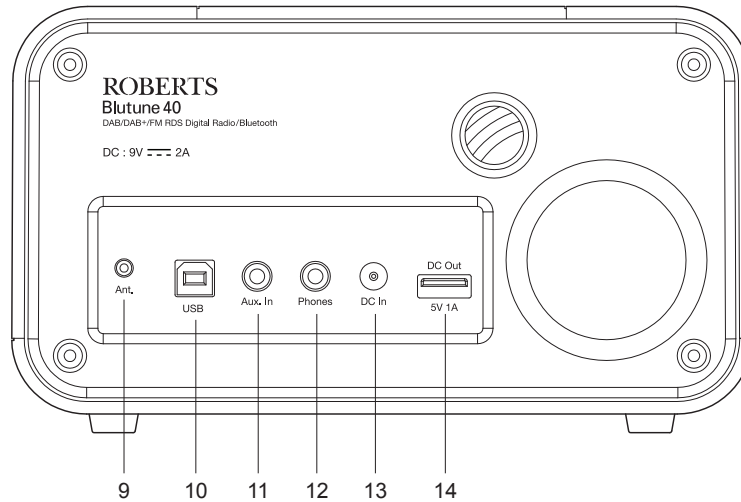

- 9. DAB / FM wire aerial
- 10. USB socket (for software upgrades only)
- 11. Auxiliary input socket
- 12. Headphone socket
- 13. DC input socket
- 14. Charging socket

Using the radio for the first time

1. Place your radio on a flat surface.
2. Fully extend the wire aerial located on the rear of your radio. Place the wire antenna so that it is as straight as possible extending either above or below the radio.
3. Insert the adaptor plug into the DC socket located on the rear of your radio. Plug the adaptor into a standard 13 amp mains socket outlet. The display will show 'WELCOME' for a few seconds. During this time the radio is scanning to find a DAB radio signal. After a short time the current time and day will appear on the display.
4. If no signal is found, '0:00' will be displayed. It may be necessary to relocate your radio to a position giving better reception. You should then carry out a scan to find stations as described on page 9.

IMPORTANT: The mains adaptor is used as the means of connecting the radio to the mains supply. The mains socket used for the radio must remain accessible during normal use. In order to disconnect the radio from the mains completely, the mains adaptor should be removed from the mains socket outlet completely.

Characters appearing on the LCD display indicate that the radio is connected to and powered from the mains supply.

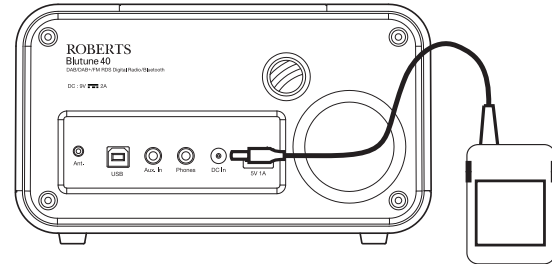

Operating your radio

1. Press and release the **On/Off** button to switch on your radio.

When first switched on, the radio will be in DAB mode. After each use the radio will remember the mode used and then switch on in that mode the next time that it is used.

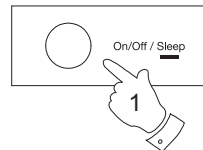

2. If the radio has been used before, the last used station will be selected.

3. If this is the first time that the radio has been used a scan of the Band III DAB channels will be carried out (depending on whether scanning was already completed in standby mode). During the scanning process the display will show the progress of the station search. The number on the right of the display is the number of stations that have been found.



4. When the scan is completed the first station (in numeric-alpha order 0...9, A...Z) will be selected. The first station in the list of stations found during scanning will be played. The display will show the station name.
 5. If no signals are found then it may be necessary to relocate your radio to a position giving better reception. You should then carry out a scan to find stations as described on page 9.
- Your radio has an indicator  on the display to indicate the strength of the DAB radio signal being received.

Note: When first switched on, the radio will set the volume to a moderately high level, in case the broadcast is very quiet. After you have set the volume using the **Volume Up** or **Down** buttons, the radio will remember the setting that you have applied for the next time that it is used.

Selecting a station - DAB

1. Press and release the **On/Off** button to switch on your radio.
2. Repeatedly, press and hold the **Mode** button until the DAB mode is selected. The display will show the name of the radio station currently selected.
3. Rotate the **Tuning** control to step through the list of available stations.
4. When the desired station name appears on the display, press and release the **Tuning** control to select the station. The radio will select the new station.
5. Adjust the **Volume** buttons to the required setting.

Note: If after selecting a station the station does not connect it may be necessary to relocate your radio to a position giving better reception.

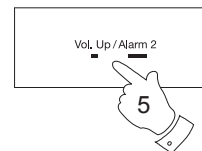
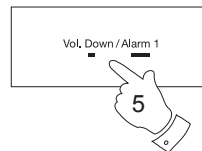
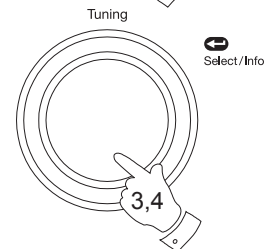
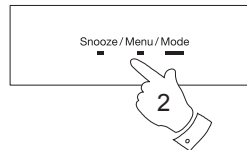
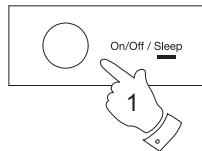

Secondary services - DAB

1. Certain radio stations have one or more secondary services associated with them. If a station has a secondary service associated with it then the secondary service will then appear immediately after the primary service as you rotate the **Tuning** control.
2. To tune to the secondary service, press and release the **Tuning** control. Most secondary services do not broadcast continually and if the selected service is not available, the radio will re-tune to the associated primary service.

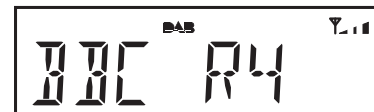
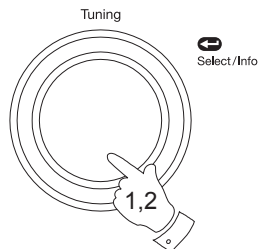

Display options - DAB

Your radio has a range of display options when in DAB mode:-

1. Press and release the **Tuning / Info** control to cycle through the various options. All display options except the text display will revert to the clock display after about 10 seconds.

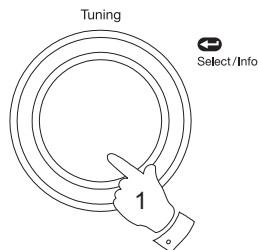

a



b



c

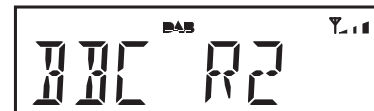

a. Time and day

Displays the current time and day of the week.

b. Date

Displays the current date.

c. Station name

Displays the DAB station name being listened to.

Display options DAB - cont

d. Scrolling text Displays scrolling text messages such as artist/track name, phone in number, etc.



e. Programme type Displays the type of station being listened to e.g. Pop, Classic, News, etc.



f. Multiplex Name Displays the name of the DAB multiplex to which the current station belongs.



g. Frequency Displays the frequency for the currently tuned DAB station.



h. Bit rate Displays the digital audio bit rate for the currently tuned DAB station.



i. Signal strength Displays the signal strength for the station being listened to. The minimum signal marker shows the minimum required signal strength for clear DAB reception.



Finding new stations - DAB

From time to time, new DAB radio stations may become available. Or you may have moved to a different part of the country. In this case you may need to cause your radio to scan for new stations.

1. Press and release the **On/Off** button to switch on your radio.
2. If needed, repeatedly press and hold the **Mode** button until the DAB mode is selected.
3. Press and release the **Menu** button. The advanced DAB menu will show on the display.
4. Rotate the **Tuning** control until the display shows 'SCAN'.
5. Press and release the **Tuning** control. Your radio will perform a scan of the Band III DAB channels. As new stations are found, the station counter on the right-hand side of the display will increase and stations will be added to the list.

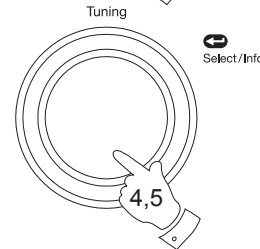
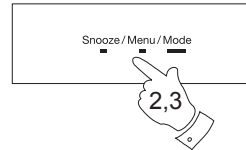
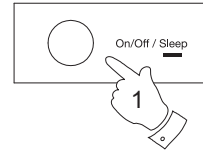

Manual tuning - DAB

Manual tuning allows you to tune your radio to a particular DAB frequency in Band III. Any new stations found will be added to the station list. This function can also be used to assist the positioning of the aerial or the radio to optimise reception for a specific channel or frequency. Note that UK DAB stations are located in the range of channels 11B to 12D.

1. Press and release the **Menu** button. The advanced DAB menu will show on the display.
2. Rotate the **Tuning** control until the display shows 'MANUAL'. Press and release the **Tuning** control to enter the manual tune mode.
3. Rotate the **Tuning** control to select the desired DAB channel.
4. Press and release the **Tuning** control to tune to the chosen frequency.
5. If a signal is present, this will be indicated on a signal strength display. The minimum signal marker (|) shows the minimum signal strength needed for good DAB reception. The signal indicator chevrons go up or down showing the changing signal strength as you adjust the wire aerial or your radio position. Press and release the **Tuning** control again to return to the normal DAB tuning mode.

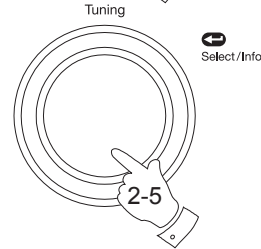
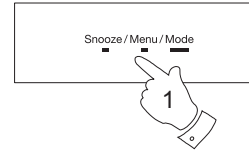

Dynamic Range Control (DRC) - DAB

The DRC facility can make quieter sounds easier to hear when your radio is used in a noisy environment.

There are three levels of compression:

- DRC 0 No compression applied. (default)
- DRC 1/2 Medium compression applied.
- DRC 1 Maximum compression applied.

1. Press and release the **On/Off** button to switch on your radio.
2. Repeatedly, press and hold the **Mode** button until the DAB mode is selected.
3. Press and release the **Menu** button. The advanced DAB menu will show on the display.
4. Rotate the **Tuning** control until 'DRC' appears on the display. Press and release the **Tuning** control. The display will show the current DRC value.
5. Rotate the **Tuning** control to select the required DRC setting (default is 0).
6. Press and release the **Tuning** control to confirm the setting. After several seconds the display will return to the normal radio display.

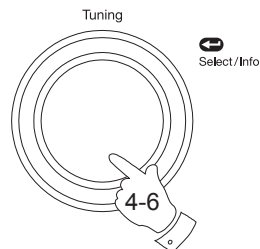
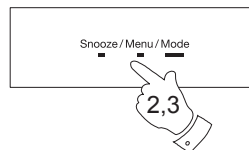
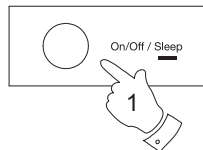

Note: Not all DAB broadcasts are able to use the DRC function. If the broadcast does not support DRC, then the DRC setting in the radio will have no effect.

Prune stations - DAB

Over time, some DAB services may stop broadcasting, or may change location and then not be able to receive a station. In order to remove such stations from the DAB station list, the Prune stations function will delete the DAB stations from your station list that can no longer be received.

Stations which cannot be found or which have not been received for a very long time are shown in the station list with a question mark.

1. Press and release the **On/Off** button to switch on your radio.
2. Repeatedly, press and hold the **Mode** button until the DAB mode is selected.
3. Press and release the **Menu** button. The advanced DAB menu will show on the display.
4. Rotate the **Tuning** control until 'PRUNE' appears on the display. Press and release the **Tuning** control.
5. Rotate the **Tuning** control to select 'Y'. Press and release the **Tuning** control to cause the stations list to be pruned, eliminating unavailable stations.
6. If you do not wish to prune stations select 'N' in step 5 and then press and release the **Tuning** control. The display will revert back to the previous display.

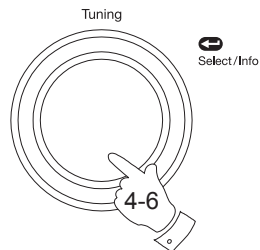
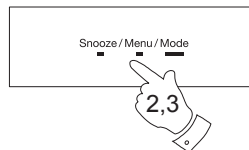
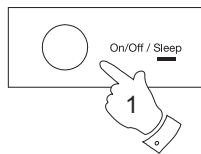

Note: If you have moved to a different part of the country you should also carry out a search for new stations (please see the section 'Finding new stations' on page 9).

Operating your radio - FM auto-tune

1. Fully extend the wire aerial located on the rear of your radio. Place the wire antenna so that it is as straight as possible extending either above or below the radio.
2. Press and release the **On/Off** button to switch on your radio.
3. Repeatedly, press and hold the **Mode** button until the FM mode is selected.
4. Rotate the **Tuning** control clockwise and then press and hold the **Tuning** control for 2 - 3 seconds to cause your radio to search from low frequency to high frequency and to stop automatically when it finds a station of sufficient strength.
5. After a few seconds the display will update. The display will show the frequency of the signal found. If the signal is strong enough and there is RDS data present then the radio may display the station name.
6. To find other stations press and hold the **Tuning** control as before.
7. Rotate the **Tuning** control anti-clockwise and then press and hold the **Tuning** control for 2 - 3 seconds to cause your radio to search from high frequency to low frequency and to stop automatically when it finds a station of sufficient strength.
8. When the end of the waveband is reached your radio will recommence tuning from the opposite end of the waveband.
9. Adjust the **Volume** to the required setting. To switch off your radio, press and release the **On/Off** button.

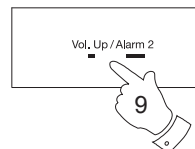
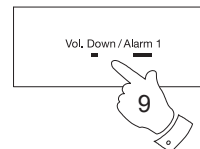
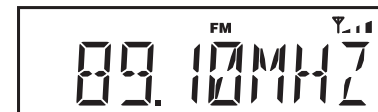
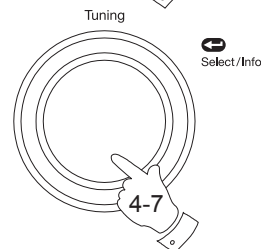
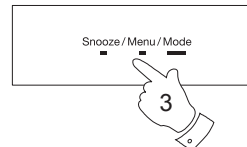
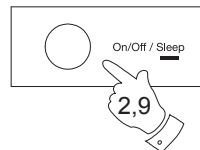

Manual tuning - FM

1. Fully extend the wire aerial located on the rear of your radio. Place the wire antenna so that it is as straight as possible extending either above or below the radio.
2. Press and release the **On/Off** button to switch on your radio.
3. Repeatedly, press and hold the **Mode** button until the FM mode is selected.
4. Rotate the **Tuning** control to tune to a station. The frequency will change in steps of 50kHz.
If the radio is tuned to a station of sufficient signal strength with RDS information present, then the display may change to show the station name.
5. When the waveband end is reached the radio will recommence tuning from the opposite waveband end.
6. Set the **Volume** to the desired setting.
7. To switch off your radio press and release the **On/Off** button.

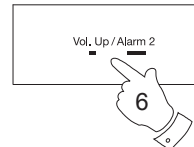
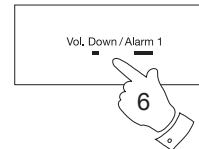
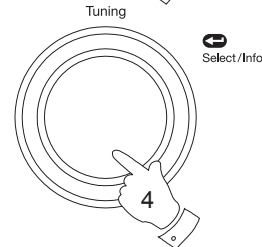
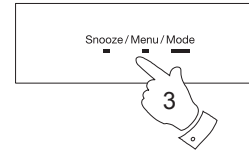
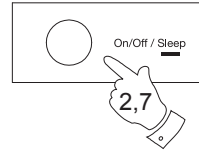

Display options - FM

Your radio has a range of display options for the FM mode:-

The Radio Data System (RDS) is a system in which inaudible digital information is transmitted in addition to the normal FM radio programme. RDS offers several useful features. The following are available on your radio.

1. Press and release the **Tuning / Info** control to cycle through the various options. All display options except the text display will revert to the clock display after about 10 seconds.

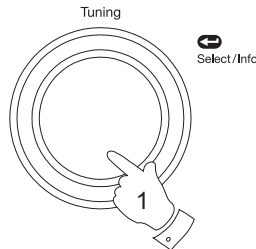

- | | |
|-------------------|---|
| a. Time and day | Displays the current time and day. |
| b. Date | Displays current date. |
| c. Station name | Displays the name of the radio station being listened to. |
| d. Scrolling text | Displays scrolling text messages such as artist/track name, phone in number, etc. |
| e. Programme type | Displays type of station being listened to e.g. Pop, Classic, News, etc. |
| f. Frequency | Displays the FM frequency of the station being listened to. |

Note: If no RDS information is available, the radio will be unable to display the station name, scrolling text and programme type information.



Scan sensitivity setting - FM

Your radio will normally scan for FM broadcasts which are strong enough to give good reception. However, you may wish the Auto-scan function to also be able to find weaker signals, possibly from more distant radio transmitters. Your radio includes a local / distant option for the Auto-scan function.

1. Press and release the **On/Off** button to switch on your radio.
2. Repeatedly press and hold the **Mode** button until the FM mode is selected.
3. Press and release the **Menu** button. The advanced FM menu will show on the display.
4. Rotate the **Tuning** control until 'SCAN' shows on the display. Press and release the **Tuning** control.
5. Rotate the **Tuning** control to switch between 'LOCAL' and 'DISTANT' options on the display. The Distant option will allow the radio to find weaker signals when scanning.
6. Press and release the **Tuning** control to confirm your selection. The radio will then revert to the normal information display. The Local or Distant setting is stored in the radio and remains in force until changed or until a System Reset.

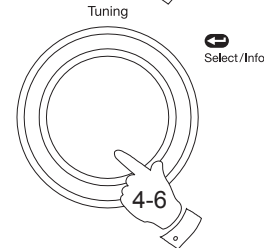
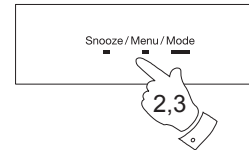
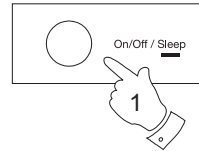

Note: The initial setting (out of the box, or after a System Reset) causes the radio to ignore weaker (or more distant) signals.

Presetting stations

You may store your preferred DAB and FM radio stations to the preset station memories. There are 20 memory presets in your radio, 10 for DAB and 10 for FM. Presets are remembered by your radio in the event of a power failure.

The procedure for setting presets and using them to tune stations is the same for FM and DAB modes, and is described below.

1. Press and release the **On/Off** button to switch on the radio.
2. Repeatedly, press and hold the **Mode** button to select either the FM or DAB mode.
3. Tune to the required station as previously described.
4. Press and release the **Preset** button. The display will show, for example, 'Empty 1' if no station has been stored to that preset.
5. Rotate the **Tuning** control to select the desired preset station number under which you wish to store the station.
6. Press and hold the **Tuning** control until the display shows, for example, 'STORED'. The station will be stored under the chosen preset. Repeat this procedure for the remaining presets.
7. Stations which have been stored in preset memories may be overwritten by following the above procedure.

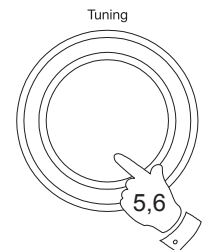
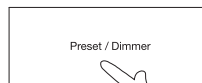
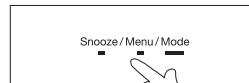
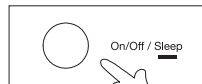

Recalling a preset station

1. Press and release the **On/Off** button to switch on the radio.
2. Repeatedly, press and hold the **Mode** button to select either the FM or DAB mode.
3. Press and release the **Preset** button. The display will show, for example, 'Empty 1' if no station has been stored to that preset. If a preset has been stored, then the display will show either the station name (for DAB stations) or the frequency (for FM stations).
4. Rotate the **Tuning** control to select the desired preset station.
5. Press and release the **Tuning** control. Your radio will tune to the chosen preset station stored in the preset memory.

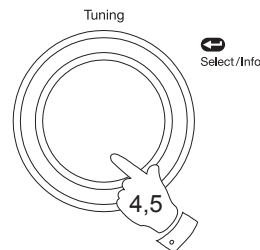
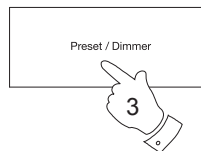
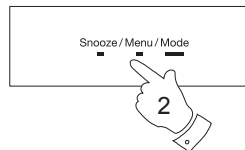
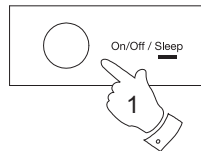

Bluetooth mode

The Bluetooth mode on your radio allows you to play audio, play sound from video files and stream music from Bluetooth capable devices such as your mobile phone, computer, tablet etc. through your radio's loudspeaker.

'Bluetooth pairing' occurs when two Bluetooth enabled devices agree to establish a connection and communicate with each other.

When a Bluetooth enabled device such as your Blutune 40 radio is in a 'discoverable' state other Bluetooth devices can detect, pair with or connect to it.

Your radio will flash its Bluetooth indicator light when it is discoverable or when it is trying to connect to a previously paired Bluetooth device. When a device is paired with and connects to your radio, the Bluetooth indicator light on the radio will remain lit.

Bluetooth connectivity performance may vary depending on the connected Bluetooth devices. Please refer to the Bluetooth capabilities of your device before connecting to your radio. All features may not be supported on some paired Bluetooth devices.

A Bluetooth connection can provide a link for audio up to a distance of approximately ten metres. When pairing two Bluetooth enabled devices, for convenience, we recommend they should be no more than 2 to 3 metres apart. The presence of other functioning Bluetooth devices during connection may lead to operational difficulties. Bluetooth is a short-range radio communication system and generally Bluetooth devices can communicate with each other clearly within a regular sized room or office. The reliability of a Bluetooth connection between different rooms will greatly depend upon the construction of the room and walls etc. Bluetooth communication range may be substantially reduced if the signal passes through a solid object.

Human bodies, brick and concrete walls, heavy furniture or bookcases will all reduce the operational range of your Bluetooth devices to a greater or lesser extent. Glass, dry-wall or wood paneled walls and office partitions may have a less severe but noticeable effect. Metal pipes, foil-lined plasterboard, metal window frames and domestic wiring can also have an effect. You should position your Bluetooth devices closer to each other if you observe communication difficulties.

WiFi networks and cordless phones generally use similar radio frequencies to Bluetooth and may interfere with one another. If any interference is noticed, then try relocating the radio or one of the other devices.

Some Bluetooth devices may require a 'Passkey' (an authentication key) in order to establish a link between devices. A passkey is similar to a password, although you only need to use the passkey once to establish a link. If your device asks for a passkey to be able to pair with your radio then enter a code of 0000 (four zeroes).

The Bluetooth capabilities of your radio enable it to receive audio from many Bluetooth capable devices including mobile phones, personal computers and PDAs. Only one Bluetooth device can be connected to your radio at a time. It supports the following Bluetooth profiles and functionality.

Your radio supports A2DP (Advanced Audio Distribution Profile) which is a stereo audio connection that streams stereo music from PCs, mobile phones etc,

Your radio supports AVRCP (Audio Video Remote Control Profile) which allows your radio to control music playback from the connected device.

Note: Some mobile phones may temporarily disconnect from your radio when you make or receive calls. Some devices may temporarily mute their Bluetooth audio streaming when they receive text messages, emails or for other reasons unrelated to audio streaming. Such behaviour is a function of the connected device and does not indicate a fault with your radio.

Connecting Bluetooth devices

1. Ensure that the Bluetooth capability on your phone, tablet or PC is enabled. You may need to refer to the user documentation for your device, since the method will vary with each device.
2. Press and release the **On/Off** button to switch on the radio.
3. Repeatedly, press and hold the **Mode** button on your radio until the Bluetooth mode is selected. Your radio will show that it is 'discoverable' by flashing the **Bluetooth indicator** on the display.
4. Using the Bluetooth settings of your phone, tablet or PC direct it to search for 'discoverable' devices. After a few seconds, you should see a device named '*Blutune 40*'.
5. Select '*Blutune 40*' to cause your phone, tablet or PC to pair with your radio and to establish a connection.
6. Once the connection is established, the **Bluetooth indicator** on the radio display will remain lit. You can now begin playing music from your phone etc.

Some Bluetooth devices may require a 'Passkey' (an authentication key) in order to establish a link between devices. A passkey is similar to a password, although you only need to use the passkey once to establish a link. If your device asks for a passkey to be able to pair with your radio then enter a code of 0000 (four zeroes).

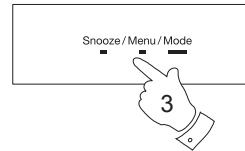
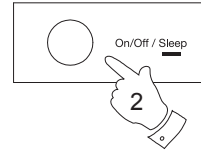

Playing audio files in Bluetooth mode

When you have successfully connected your radio with the chosen Bluetooth device you can start to play your music using the controls on your connected Bluetooth device.

1. Once playing has started adjust the volume to the required setting using the **Volume** buttons on your radio or your enabled bluetooth device.
2. Provided that your phone, tablet or PC allows volume control when using Bluetooth we recommend that for normal Bluetooth listening the radio's volume control is set to a high level. This will permit the audio volume to be controlled using the connected Bluetooth device. This will generally be the more convenient method of controlling the volume. However, if you are using headphones plugged into your radio, we strongly recommend that the radio's volume control is used as the means of adjusting the audio volume. You will then need to set the volume on the connected Bluetooth device to a higher level. The purpose here is to prevent unexpectedly loud noises in the headphones, when changing modes in the radio or when switching on and off.
3. The audio player in your phone, tablet or PC may be able to respond to the **Play/Pause**, **Next** track and **Previous** track controls on the radio. To play or pause the audio press and release the **Tuning** control. To access the next or previous track, rotate the **Tuning** control clockwise or anti-clockwise as required.

Note: That not all player applications or devices may respond to all of these controls.

Note: If the unit is in the Bluetooth mode and it is not connected to a Bluetooth device for more than 15 minutes it will automatically switch to the standby mode. The LCD will revert to the standby mode clock display. To use the radio again, simply press the On/Standby button to switch it on.

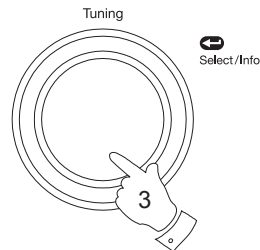
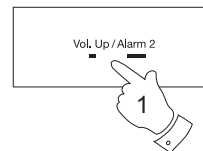
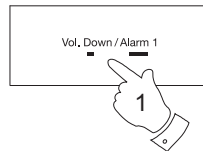

Disconnecting a Bluetooth device

You can only have one Bluetooth device connected to the radio at any one time although it may be paired with several devices.

Once you have a Bluetooth enabled device connected to your radio it cannot be interrupted by another Bluetooth device unless you choose to break the connection.

1. To force a disconnection, press and release the **Menu** button on the radio. 'PAIRING' will flash on the radio's display.
2. Press and release the **Tuning** control. The radio will sound a double beep provided that your radio's volume is set to a suitable listening level.
3. The radio will disconnect device and then will become 'discoverable' for a period of approximately 60 seconds. The **Bluetooth indicator** will flash on the screen. You may then pair your radio with a new device. Some Bluetooth devices will automatically connect while others may need you to confirm the connection. If no new connection is made, then the radio will attempt to reconnect to the previously connected device.
4. If you no longer want your Bluetooth device to be paired with your radio you will need to delete the relevant pairing on the device. Please refer to the Bluetooth documentation for your phone, tablet, PC etc. for details of how to cancel current pairings.

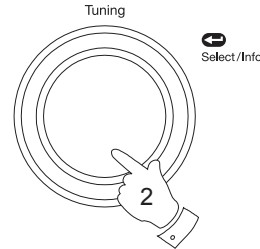
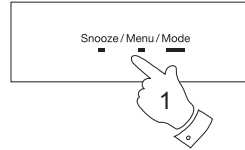

Setting alarm times

Your radio has two alarms which can be set to wake you to DAB, FM radio or beep type alarm. Each alarm can be set to sound once, daily, on weekdays or at weekends.

Note: The alarms can only be set when your radio is in standby mode.

Note: If no buttons are pressed for 1 minute, your radio will exit the alarm setup.

1. If necessary, press and release the **On/Off** button to switch off your radio.
2. Press and hold the **Alarm 1** or **Alarm 2** button.
3. 'Alarm 1' or 'Alarm 2' will show on the display and the alarm indicator will flash on the display.
4. Press and release the **Tuning** control to enter the alarm setting menu.
5. Rotate the **Tuning** control to select ON or OFF. If OFF is selected any current setting for that alarm will be cancelled.
6. With 'ON' selected press and release the **Tuning** control to cause the alarm hour digits to flash on the display.
7. Rotate the **Tuning** control to choose the desired alarm hour.

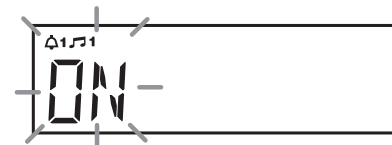
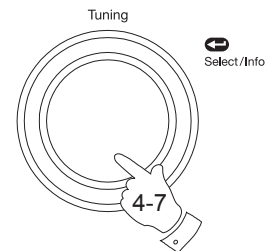
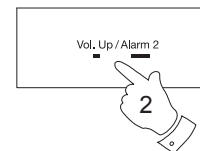
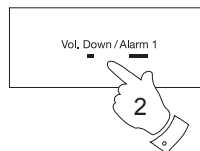
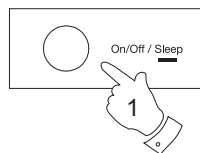

8. Press and release the **Tuning** control to enter the hour setting. The alarm minute digits will flash on the display.

9. Rotate the **Tuning** control to choose the desired alarm minute.

10. Press and release the **Tuning** control to enter the minutes setting. The alarm day option will flash on the display.

• If your radio has been set to use the 12 hour clock format there will be an option here to set either AM or PM.

11. Rotate the **Tuning** control to choose the desired alarm day option:

- | | |
|----------|-------------------------------|
| Once | - Will sound at one time only |
| Weekends | - Will sound only on weekends |
| Weekdays | - Will sound only on weekdays |
| Daily | - Will sound everyday |

• If setting the alarm to once only, continue with step 12 below. Otherwise skip to step 18 on the following page.

12. Press and release the **Tuning** control to enter the setting. The alarm day will flash on the display.

13. Rotate the **Tuning** control to choose the alarm day.

14. Press and release the **Tuning** control to enter the alarm day setting. The alarm month will flash on the display.

15. Rotate the **Tuning** control to choose the alarm month.

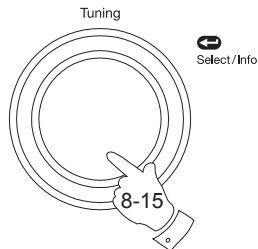

16. Press and release the **Tuning** control to enter the alarm month setting. The alarm year will flash on the display.

17. Rotate the **Tuning** control to choose the alarm year.

18. Press and release the **Tuning** control to enter the setting. The alarm source option will flash on the display.

19. Rotate the **Tuning** control to choose the desired alarm source (DAB, FM, BUZZER).

If setting the alarms to the radio option, the radio alarm may be set to the last listened radio station or any of the stations which have been stored as presets.

Rotate the **Tuning** control to choose either 'LAST' to wake up to the last listened radio station or from a preset on the display.

Note: That you can only set the alarm to use a preset which has already been stored. Please see 'Presetting stations' page 17.

20. Press and release the **Tuning** control. The volume setting will show on the display.

21. Rotate the **Tuning** control to choose the desired alarm volume. The radio uses the saved volume settings for each radio alarm when it sounds.

22. Press and release the **Tuning** control to confirm the alarm settings. 'SAVED' will show on the display before exiting the alarm setup.

Radio alarms are indicated in the display by the 🎵 symbol and the corresponding alarm number. Buzzer alarms are indicated by the 🔔 symbol and the corresponding alarm number.

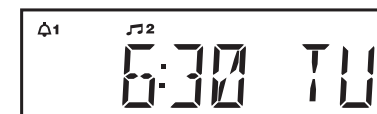
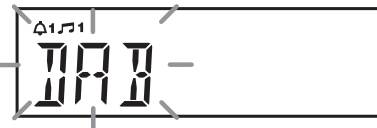
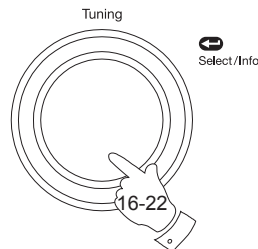

When the alarm sounds

The alarm will sound at the selected times for up to 60 minutes unless cancelled. The maximum volume used for the radio alarm will be specified during the alarm setting procedure.

When your radio is set to wake by the radio alarm, your radio will switch to the selected radio station. If the radio cannot connect to the specified radio station, the buzzer will be used instead.

Note: If the radio is switched on because of a radio alarm you can control basic functions such as the volume control.

When the buzzer alarm activates it will start softly and gradually increase in level.

The alarm icon will flash on the screen and the radio will automatically switch back to standby mode when the 60 minutes have elapsed.

Cancelling alarms

1. Whilst an alarm is sounding, press and release the **On/Off** button to cancel the alarm.

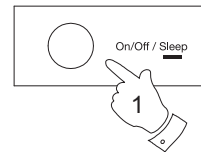

Snooze function

1. When the radio or buzzer alarm sounds, press and release the **Snooze** button. This will silence the alarm for 5 minutes.

When the Snooze button has been pressed during an alarm, the display will show the Snooze symbol **z^{zz}**. This sequence can be repeated during the 60 minute alarm period.

2. To cancel the Snooze function, press and release the **On/Off** button.

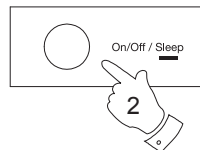
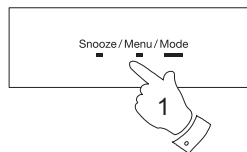

To view the alarm settings

1. Press and release the **On/Off** button to switch off the radio if needed.
2. Press and hold **Alarm 1** or **Alarm 2** button to enter the alarm setup.
3. Repeatedly, press and release the **Tuning** control to cycle through each of the settings for the chosen alarm.

You may use the Tuning control to modify any particular setting if desired, using the Tuning control to enter the modification.

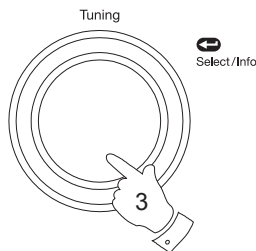
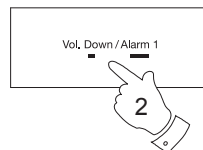

Sleep function

Your radio can be set to turn off after a preset time has elapsed. The sleep setting can be adjusted between 15 and 90 minutes in increments. Ensure your radio is switched on.

1. When using your radio, press and hold the **Sleep** button and then release the button. The sleep symbol  will flash on the display.
2. Rotate the **Tuning** control to select the desired sleep time. The sleep setting will increase in increments from 15 minutes up to 90 minutes. A further increment will cause the sleep timer to be set to OFF which will cancel the sleep function.
3. Press and release the **Tuning** control. The display will exit the sleep options.
4. Your radio will switch off after the preset sleep time has elapsed.
5. To view the remaining sleep time, press and hold the **Sleep** button and then release the button. The remaining sleep time will show on the display.
6. To cancel the sleep timer and switch off your radio before the chosen sleep time has elapsed, press and release the **On/Off** button.
To cancel the sleep timer without switching off your radio, set the sleep timer to the OFF setting.

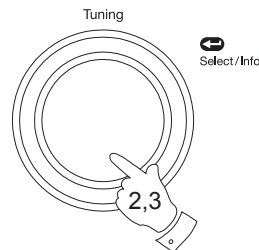
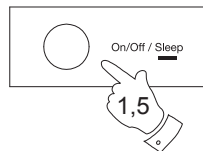

Setting the clock format

The clock display used in standby mode and when the radio is in use can be set to 12 or 24 hour format. The clock format can only be set while the unit is playing. The selected format is then also used when setting the alarms.

1. Press and release the **On/Off** button to switch on the radio.
2. To set the clock format, press and release the **Menu** button. The advanced menu will show on the display.
3. Rotate the **Tuning** control until 'SYSTEM' appears on the display. Press and release the **Tuning** control.
4. Rotate the **Tuning** control until 'TIME' appears on the display. Press and release the **Tuning** control.
5. Rotate the **Tuning** control until '12/24 HR' appears on the display. Press and release the **Tuning** control.
6. Rotate the **Tuning** control to display either 12 or 24 hour format.
7. Press and release the **Tuning** control to confirm setting.

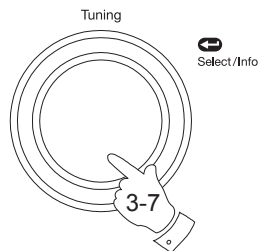
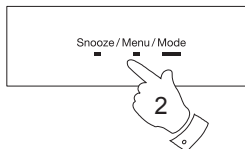
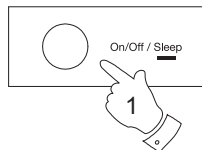

If the 12 hour clock format is chosen, the radio will then use the 12 hour clock for the setting of alarms, and will display a 12 hour clock with an AM or PM indicator on the display.

Setting the clock manually

Normally your radio will set its clock automatically using the DAB radio signal. If no DAB signal is available and you need to set the time manually, please follow the procedure shown below.

1. Press and release the **On/Off** button to switch on the radio.
2. To set the clock time, press and release the **Menu** button until the advanced menu shows on the display.
3. Rotate the **Tuning** control until 'SYSTEM' appears on the display. Press and release the **Tuning** control.
4. Rotate the **Tuning** control until 'TIME' appears on the display. Press and release the **Tuning** control.
5. Rotate the **Tuning** control until 'SET TIME' appears on the display.
6. Press and release the **Tuning** control to enter the manual setting procedure. The hour digits will then flash on the display.
7. Rotate the **Tuning** control to set the desired hour.
8. Press and release the **Tuning** control to enter the hour setting.
9. The minute digits will then flash on the display. Rotate the **Tuning** control to set the desired minute.

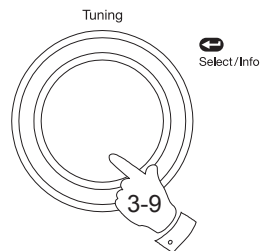
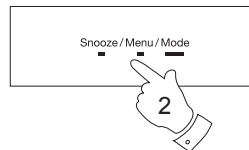
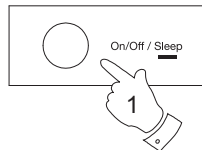

Setting the clock manually - cont

10. Press and release the **Tuning** control to enter the minutes setting. The day will then flash on the display.
 - If your radio has been set to use the 12 hour clock format there will be an option here to set either AM or PM.
11. Rotate the **Tuning** control to select the current day.
12. Press and release the **Tuning** control to enter the day setting. The month will then flash on the display.
13. Rotate the **Tuning** control to select the current month.
14. Press and release the **Tuning** control to enter the month setting. The year will then flash on the display.
15. Rotate the **Tuning** control to select the current year.
16. Press and release the **Tuning** control to confirm the time setting. 'SAVED' will show on the display before exiting the clock setup.

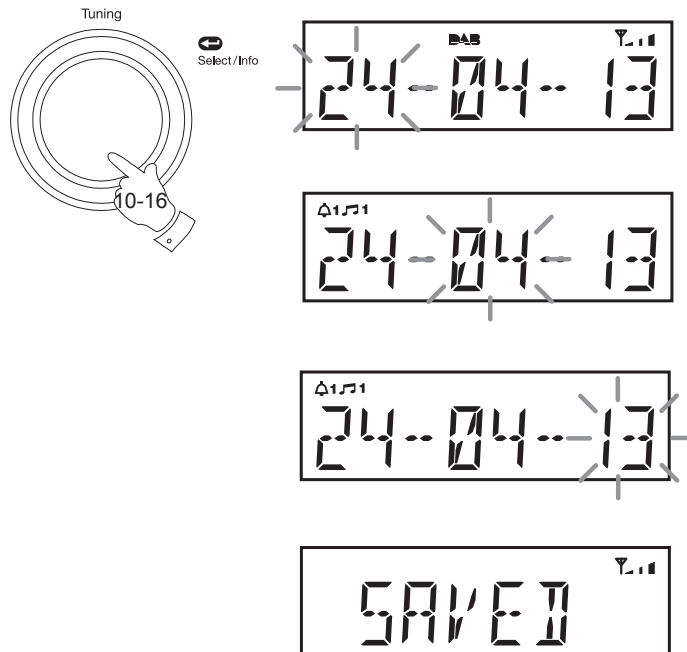

Automatically updating the clock

Your radio will usually set the clock time using the DAB signal. You may specify that the radio sets its clock from the DAB or FM waveband, either waveband or none. If you choose none you will need to set the clock manually.

1. Press and release the **On/Off** button to switch on the radio.
2. Press and release the **Menu** button until the advanced menu shows on the display.
3. Rotate the **Tuning** control until 'SYSTEM' appears on the display. Press and release the **Tuning** control.
4. Rotate the **Tuning** control until 'TIME' appears on the display. Press and release the **Tuning** control.
5. Rotate the **Tuning** control until 'UPDATE' appears on the display. Press and release the **Tuning** control.
6. Rotate the **Tuning** control to choose an update option from, 'ANY, DAB, FM or NONE.
7. Press and release the **Tuning** control to confirm your choice.
8. The radio will set its time according to the information received. The radio will return to the previous menu display.

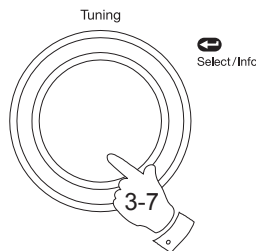
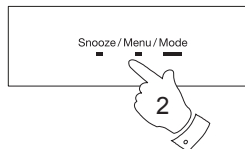
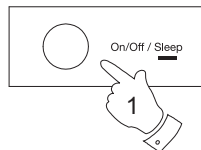

If a signal is not found you should then either position the radio or its aerial so that a signal can be received, or revert to manual clock mode (see page 30).

Clock display

1. The clock display on your radio can be shown using either a 12 or 24 hour clock format.



Display backlight dimmer

The brightness of the display can be adjusted when the radio is in standby or when the unit is in use.

1. In order to adapt the intensity of the display to suit the ambient room lighting when the unit is in the standby mode, press the **Dimmer** button on your radio to select the dimmer brightness from High-Medium-Low and an almost off 'night-time' setting.
2. Alternatively when your radio is in use, press and release the **Menu** button until the advanced menu shows on the display.
3. Rotate the **Tuning** control until 'SYSTEM' appears on the display. Press and release the **Tuning** control.
4. Rotate the **Tuning** control until 'DIMMER' appears on the display. Press and release the **Tuning** control.
5. Rotate the **Tuning** control to choose between, 'LOW', 'MEDIUM', 'HIGH' or to 'OFF'.
6. Press and release the **Tuning** control to confirm your selection.
 - When the radio is in standby mode, pressing a button (other than the dimmer button) or turning the rotary control will cause the radio to switch to a higher brightness level for a few seconds. This is so that if the standby brightness level is set to the almost off 'night time' setting, it is possible to see the time.

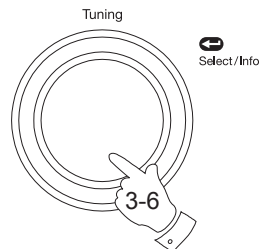
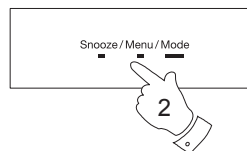
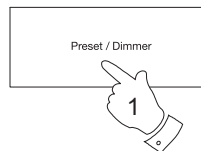

Software version

The software display cannot be altered and is just for your reference. Ensure your radio is switched on.

1. Press and release the **On/Off** button to switch on your radio.
2. Press and release the **Menu** button. The advanced menu will show on the display.
3. Rotate the **Tuning** control until 'SYSTEM' shows on the display.
4. Press and release the **Tuning** control.
5. Rotate the **Tuning** control until 'SW VER' shows on the display.
6. Press and release the **Tuning** control. The display shows the software information.
7. Press and release the **Menu** button to exit the software display.

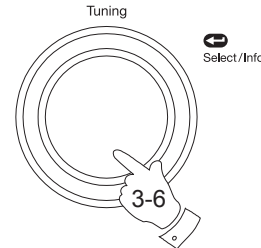
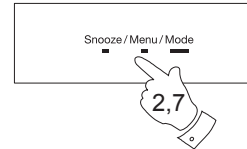
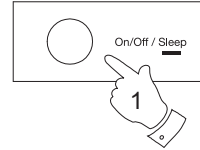

Language function

Your radio can be configured to a different language. Ensure your radio is switched on.

1. Press and release the **On/Off** button to switch on your radio.
2. Press and release the **Menu** button. The advanced menu will show on the display.
3. Rotate the **Tuning** control until 'SYSTEM' shows on the display.
4. Press and release the **Tuning** control.
5. Rotate the **Tuning** control until 'LANGUAGE' appears on the display.
6. Press and release the **Tuning** control to enter the language adjustment menu.
7. Rotate the **Tuning** control until your desired language appears on the display.
8. Press and release the **Tuning** control to confirm your choice. The display will change to the chosen language.

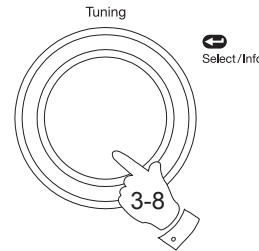
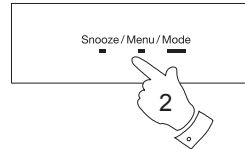
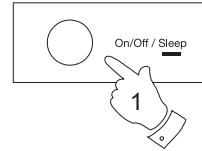

System reset

If your radio fails to operate correctly, or some digits on the display are missing or incomplete carry out the following procedure.

1. Press the **On/Off** button to switch on the radio. Press and release the **Menu** button. The advanced menu will show on the display.
2. Rotate the **Tuning** control until 'SYSTEM' shows on the display. Press and release the **Tuning** control.
3. Rotate the **Tuning** control until 'RESET' shows on the display. Press and release the **Tuning** control.
4. Rotate the **Tuning** control until 'Y' appears on the display. If you do not wish to carry out a system reset, highlight 'N' and then press and release the **Tuning** control. The display will revert to the previous display.
5. With 'Y' displayed, press and release the **Tuning** control. A full reset will be performed. The station list and presets will be erased. Alarms will be cancelled and settings will be set to their default values. The display will show 'WELCOME' and after a short time the current time and day will appear on the display.
6. See 'Operating your radio' on page 4 for further details.

In case of malfunction due to electrostatic discharge, reset the product as above to resume normal operation. If you are not able to perform the reset operation as above, removal and reconnection of the power supply may be required.

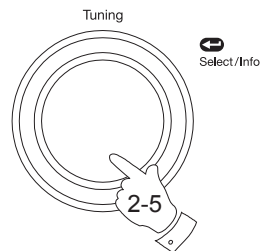
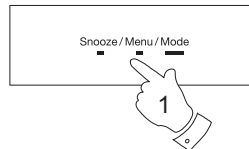
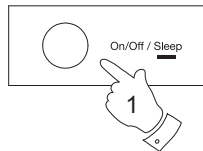

Headphone socket

A 3.5mm **Headphone Socket** located on the rear of your radio is provided for use with either headphones or an earpiece. Inserting a plug automatically mutes the internal loudspeaker.

Please be aware that the sensitivity of headphones can vary widely. We therefore recommend setting the volume to a low level before connecting headphones to the radio.

IMPORTANT: Excessive sound pressure from earphones and headphones can cause hearing loss.



To prevent possible hearing damage, do not listen at high volume levels for long periods.

Auxiliary input socket

1. Connect a stereo or mono audio source (i.e. CD player, MP3 player, etc.) to the **Auxiliary input** socket.
2. Press and release the **On/Off** button to switch on the radio.
3. Repeatedly press and hold the **Mode** button until the display shows 'AUX IN'.
4. Adjust the **Volume** control on your player and on the radio for comfortable listening.
5. Remove the cable from the **Auxiliary input** socket or press and hold the **Mode** button to cancel Auxiliary Input mode.

Note: If the radio is in Auxiliary input mode with no input signal being applied for more than 15 minutes then it will automatically switch to the standby mode. The LCD will revert to the standby mode clock display. To use the radio again, simply press the On/Standby button to switch it on.

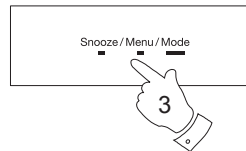
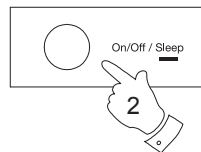
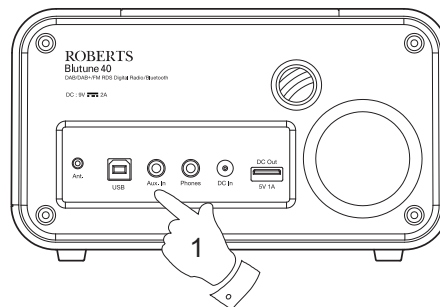
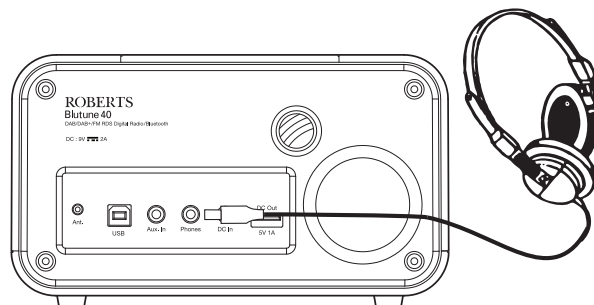

USB socket for iPhone or smartphone charging

Your radio has a USB socket which is intended only for charging an iPhone or smart phone and similar devices.

Charge time may vary and in some cases may take longer to charge than when using the manufacturers charging unit supplied with the smart phone.

1. Ensure your radio is plugged in.
2. Connect your smart phone to the USB charging socket at the rear of your radio.
3. Your iPhone or smart phone will begin to charge.
4. Once your iPhone or smart phone has charged remove the USB lead.

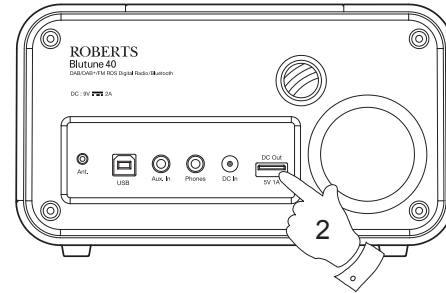

Software upgrades

In the event that any software update is made available for your radio, information on how to update your radio will be made available via our website at <http://www.robertsradio.com>

Cautions

Do not allow this radio to be exposed to water, steam or sand. Do not leave your radio where excessive heat could cause damage such as in a parked car where the heat from the sun can build up even though the outside temperature may not seem too high. It is recommended that the DAB band be used wherever possible as better results in terms of quality and freedom from interference will usually be obtained than on the FM band.

- The name plate is located on the rear of the unit.



- Your radio should not be exposed to dripping or splashing and that no objects filled with liquids, such as vases, shall be placed on the radio.
- It is recommended to operate the product such that there is a minimum distance (10cm recommended) to adjacent objects in order to ensure good ventilation.
- The ventilation of the product should not be restricted by covering it or its ventilation openings with items such as newspapers, tablecloths, curtains etc.
- No naked flame sources such as lighted candles should be placed on the product.
- It is recommended to avoid using or storing the product at extremes of temperature. Avoid leaving the unit in cars, on window sills, in direct sunlight etc.

Specifications

Power Requirements

Mains AC 230V  50/60 Hz (Adaptor)

Frequency Coverage

FM 87.5-108MHz
DAB 174.928 - 239.200MHz

Circuit Features

Loudspeaker 78 mm
Output Power 5 Watt

Headphone socket 3.5mm dia
Auxiliary input socket 3.5mm dia

Aerial System FM Wire aerial
DAB Wire aerial

The Company reserves the right to amend the specification without notice.

Guarantee

This product is guaranteed for twelve months from the date of purchase by the original owner against failure due to faulty workmanship or component breakdown, subject to the procedure stated below. Should any component or part fail during this guarantee period it will be repaired or replaced free of charge.

The guarantee does not cover:

1. Damage resulting from incorrect use.
2. Consequential damage.
3. Product with removed or defaced serial numbers.

Procedure:

Any claim under this guarantee should be made through the dealer from whom the product was purchased. It is likely that your Roberts dealer will be able to attend to any defect quickly and efficiently, but should it be necessary the dealer will return the product to the company's service department for attention. In the event that it is not possible to return the product to the Roberts dealer from whom it was purchased, please contact Roberts Radio using the contact details on the www.robertsradio.com website.

For product repairs falling outside the guarantee period, please refer to the "customer care" tab on the www.robertsradio.com website.

These statements do not affect the statutory rights of a consumer.



Issue 2

ROBERTS RADIO LIMITED

PO Box 130
Mexborough
South Yorkshire
S64 8YT

Website: <http://www.robertsradio.com>

© 2013, 2014 Roberts Radio Limited

